

CLIMB HIGHER

PRODUCT CATALOG VOLUME 20.2



POWERED BY



COLUMBIA
SAFETY AND SUPPLY



AMERICA'S PREMIER OUTFITTER

WWW.GMESUPPLY.COM

(800) 940-6762

FALL PROTECTION // LIFTING & RIGGING // ROPE & RESCUE // PPE & WORK WEAR // TOOLS



WHY DO YOU CLIMB?

We all rely so much on our cell phones and being connected at all times. Being a part of everything that goes into keeping everyone online is rewarding. There's so much hard work required to build and keep the towers up and running. Most people don't recognize it, but the work I do comes with a huge sense of pride.

- #RealTowerClimber

CATALOG BADGES

Look for these badges throughout the catalog, which signify the following:

- NEW** New gear
- QUICK SHIP** Gear Expert favorites which typically ships same day
- VIDEO** Product videos available online at www.youtube.com/gmesupply
- KITS SAVE CASH** Save money on our bundled products
- MADE IN USA** **IMPORTED** Country of origin
- SIZING CHART ONLINE** Sizing charts available online at www.gmesupply.com/sizing-charts
- FREE DOWNLOAD** Free document download at www.gmesupply.com/learn
- CSA COMPLIANT** CSA compliant product
- 6 FT FREE FALL** **12 FT FREE FALL** Lanyard free fall distance
- CLASS A** **CLASS B** ANSI Z359.14-2014 SRL & PFL class
- LE** ANSI rated Leading Edge SRL
- CLASS A** **CLASS B** ANSI Z308.1 First Aid class
- ASME B30 COMPLIANT** ASME B30 standard for lifting & rigging
- FR** Flame resistant product for ARC flash applications
- FLAME RETARDANT** Flame retardant product for welding applications
- H2O** Water repellent product
- XS** **XL** Bucket volume: XS-XL
- ANSI 289.1 TYPE I** **ANSI 289.1 TYPE II** ANSI / ISEA Z89.1-2014 Hard hat marking: Type I & Type II
- ANSI 289.1 CLASS C** **ANSI 289.1 CLASS E** ANSI / ISEA Z89.1-2014 Hard hat electrical class: C, E, G
- 4344** EN388 glove protection level
- A1** **A9** ANSI 105 standard Glove cut resistance level: A1-A9
- ANSI 107 P2** **ANSI 107 R3** ANSI 107-2015 Hi-visibility gear marking: 01, P2, P3, R2, R3, E



WELCOME:

GME Supply Company is North America's premier outfitter of fall protection, safety equipment, and gear for at-height workers, industry, and construction. We tirelessly focus on unmatched customer service, prompt delivery, and continued innovation.

We are Gear Experts®. Combining industry knowledge with professional experience, we understand the specialized needs of your company. Climb Higher® with GME Supply Company, your trusted resource for expert advice and superior service.

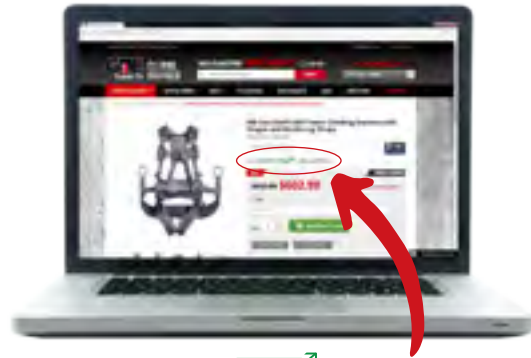

LOOK FOR  **QUICK SHIP**
ONLINE AT WWW.GMESUPPLY.COM

See if it's in stock! Our world class website has real time inventory, letting you see instantly what is on our shelves, ready to ship. Look for the above graphic for items which typically ship out same day if ordered before 7:00 pm EST.

INFORMATION:

Phone: (718) 210-3913
Fax: (888) 511-0457

A Division of:



Corporate Office:
1391 E. Boone Industrial Blvd.
Columbia, MO 65202

Atlanta Branch:
4720 Robinson Drive SW
Atlanta, GA 30336

Dallas Branch:
1075 S. Beltline Road, Ste 200
Coppell, TX 75019

Corona Branch:
830 E. Parkridge Ave.
Corona, CA 92879

PROUD MEMBERS OF



NOTICE: GME Supply, GME Supply Co. logo, Columbia Safety and Supply logo, Climb Higher, and Gear Experts are registered trademarks of GMES LLC, and are protected by law in the United States and abroad. All other trademarks contained within are the property of their respective owners. We are not responsible for typographical or photographic errors. Always refer to manufacturers recommendations. Prices are subject to change without notice. © 2019 GME Supply Co. All rights reserved.



WARNING: Some products in this catalog may expose you to chemicals known to the State of California to cause cancer or reproductive harm. For more information, go to www.P65Warnings.ca.gov



GEAR EXPERTS®

Every member of our team has extensive industry know-how and our huge gear selection means we can get you exactly what you need, when and where you need it. But your experience with your Gear Expert® doesn't stop there. We aim to build a partnership with every one of our customers. That way, you can trust us to get you the gear to not only get the job done, but keep you and your workers safe.

FIND YOUR GEAR EXPERT®:



Bryan Dominique

CT, DC, DE, MA, MD, ME, NC, NH, NJ, RI, VA, VT, WV
 bryan.dominique@gmesupply.com | (573) 234-4405



Cody Sellers

AK, CO, ID, KS, MT, ND, NE, OR, SD, UT, WA, WY
 cody.sellers@gmesupply.com | (573) 917-4468



Jim Zepp

AR, OK, LA, MS, NM, TX
 jim.zepp@gmesupply.com | (573) 234-4401



Michael Obuchowski

AZ, CA, HI, NV
 michael.obuchowski@gmesupply.com | (573) 514-8133



Mike Krohn

IA, IL, KY, MO, MN, TN, WI
 mike.krohn@gmesupply.com | (573) 281-4423



Austin Painter

IN, MI, NY, OH, PA
 austin.painter@gmesupply.com | (573) 303-3864



Tyler Nelson

AL, FL, GA, SC
 tyler.nelson@gmesupply.com | (573) 283-8105

TABLE OF CONTENTS

- **8-25 // HARNESSSES**
Tower Harnesses, Kits, 1 D-Ring, 3 D-Ring, Rope Access, Accessories
- **26-32 // LANYARDS**
Twin & Single Leg Shock Absorbing, Tie-Back
- **33-35 // POSITIONING**
Lanyards, Assemblies
- **36-44 // SRLS**
Personal Fall Limiters, SRLs, Leading Edge
- **45-48 // ANCHORAGE**
Anchor Slings, Rooftop Anchorage, Parapets, Concrete, Steel, Beam Anchors, Horizontal Lifelines
- **49-53 // HARDWARE**
ANSI Rated Connectors, Non-ANSI Rated Connectors
- **54-77 // ROPE & RESCUE**
Kernmantle, 3-Strand Lifelines, Rope Kits, Bags, Rope Grabs, Ascenders, Pulleys, Termination, Edge Protection, Slings, Haul Systems, Rescue Kits
- **78-81 // VERTICAL SYSTEMS**
Cable Safe Climb Systems, Cable Safety Sleeves
- **82-96 // LIFTING & RIGGING**
Capstan Hoists, Load Rope, Rigging Blocks, Shackles, Guy Wire Equipment, Reel Stands, Turnbuckles, Anchorage, Dynamometers, Chain & Lever Hoists
- **97-107 // INDUSTRY**
Perimeter Protection, Roofing, Utility, Tree Care, Wind, Solar, Stage & Production
- **108-110 // CONFINED SPACE**
Gas Detection, Davit & Tripod Systems
- **111-119 // BAGS & BUCKETS**
Lift Buckets, Canvas Bags, Topped Bolt Bags, Tool Holsters, Equipment Bags, Tool Pouches
- **120-146 // PERSONAL SAFETY**
Safety Helmets, Headlamps, Hearing Protection, Eye Protection, Gloves, Respirators, First Aid, Cooling, Warming, Ergonomics
- **147-154 // APPAREL**
Disposable Clothing, Flame-Resistant, Performance, Hi-Visibility, Work Boots, GME Swag, Custom Company Logo Shirts
- **155-159 // HAZARD WARNING**
Signs & Stands, Truck Lights, Traffic Safety, Cones, Fold Up Signs, Jobsite Banners, Telecom Signs
- **160-165 // SITE CONSUMABLES**
Exothermic Welding, Grounding, Tower Consumables
- **166-172 // INDUSTRIAL SUPPLIES**
Tower Paint & Supplies, Cold Galvanizing Compound, Fire Safety, Lockout/Tagout, Ladders, Power & Light
- **173-190 // TOOLS**
Milwaukee, Bosch Tools, Hougden, Hand Tools, Tool Tethers, Measuring Tools, Telecom Tools
- **191-205 // DEVICES**
Two-Way Radios, Anritsu, Antenna Alignment, Tech Tools
- **206-210 // TRAINING & INDEX**
Safety LMS, Standards Index, Featured Brands, Knowledge Base



The logo for NATE, featuring the word "NATE" in a bold, white, sans-serif font. The letter "A" is stylized with a blue and orange swoosh underneath it.

NATE

PIONEERS OF INDUSTRY.

We were the first to meet the challenges of an industry that demands skills, determination and fearless pride in a job well done.

LEARN MORE

natehome.com | 888.882.5865



The Communications Infrastructure
Contractors Association

WHAT'S NEW?

FREE
DOWNLOAD

Adjustable to fit your needs, extreme comfort, quick and easy donning, and built to maximize airflow. The **Petzl Volt International Harness** feels and works as good as it looks. Designed with all climbers in mind, it meets both American and European standards. [pg 14](#) ▶



Innovative, safe, durable, comfortable, and American made. The **FrenchCreek Stratos Harness** checks all these boxes and more. With optional comfort shoulder and back pads, built-in leg pads, and open-celled air-mesh for breathability, this harness is up for any challenge. [pg 22](#) ▶



The **SafeWaze V-Line Dual Leg Lanyard** is designed to offer optimum maneuverability without compromising safety. Featuring a low profile and lightweight construction - this lanyard can make long days a little easier. And, the stamped steel rebar snap hooks are easy to operate without sacrificing strength. [pg 30](#) ▶



Mechanical advantage can make all the difference. The **WestFall Pro Mini Haul Kit** is compact and easy to take from job site to job site while still offering 4:1 and 5:1 mechanical advantage options. Featuring high-quality WestFall Pro hardware and rope, this mini haul kit is a must-have for every crew. [pg 73](#) ▶



HARNESSES

- 14 - **Petzl VOLT International Version**
- 22 - **FrenchCreek Stratos Tower Climbing Harness**

LANYARDS

- 30 - **SafeWaze V-Line Dual-Leg Lanyard**

ROPE & RESCUE

- 57 - **WestFall Pro PSK**
- 73 - **WestFall Pro Mini Haul Kit**

VERTICAL SYSTEMS

- 79 - **Miller Glideloc Rail Ladder Climbing System - Galvanized**

LIFTING & RIGGING

- 86 - **Sterling Rope 1/2 Inch VerGo Load Line**

PERSONAL SAFETY

- 120 - **Lift Safety DAX Fifty 50 Carbon Fiber Full Brim Hardhat**
- 120 - **Lift Safety DAX Fifty 50 Carbon Fiber Cap**
- 126 - **PMI Strikeforce**
- 144 - **Ergodyne Chill-Its Hi-Vis Ranger Hat with Cooling Towel**
- 144 - **Ergodyne Chill-Its High Performance Dew Rag with Polymers**
- 144 - **Ergodyne Chill-Its Cooling Triangle Hat with Cooling Towel**
- 144 - **Ergodyne Chill-Its Cooling Bandana with Cooling Towel**
- 144 - **Ergodyne Chill-Its Evaporative FR Cooling Bandana**
- 144 - **Ergodyne Chill-Its Evaporative Cooling Towel**
- 144 - **Ergodyne Chill-Its Evaporative Cooling Band**
- 145 - **Sqwincher Sqweeze Pops - Assorted Flavors**
- 145 - **Sqwincher ZERO Sugar Qwik Stik Hydration Drink Mix - 20 oz.**
- 145 - **Sqwincher 5 Gallon Powder Pack**
- 145 - **Sqwincher ZERO Qwik Stik Tubes - Assorted Flavors**
- 145 - **Ergodyne Chill-Its Wide Mouth Water Bottle**
- 145 - **Ergodyne Chill-Its Neck Shade with Cooling Towel**
- 145 - **Ergodyne Chill-Its Evaporative Cooling Hard Hat Pad with Polymers**
- 145 - **Ergodyne Chill-Its Evaporative Cooling Hard Hat Pad with Cooling Towel**
- 145 - **Ergodyne Chill-Its Terry Sweatband**

The Lift Safety DAX hard hats have taken the world by storm. The unique Lift Safety DAX Fifty 50 Green Carbon Fiber Full Brim Hard Hat is an exclusive color you won't find anywhere else. Offering the design features of the traditional DAX Fifty 50 hard hats, the exclusive green provides a unique spin on an ultra-popular hard hat. [pg 120](#) ▶



Designed with stealth in mind the PMI Strikeforce Helmet is the first choice among the world's elite combat, fire, rescue, and enforcement teams. The matte finish contains no visible logo or reflective material to provide an aggressive-looking reflective-free surface. It offers a goggle mount, earmuff clips, a headlamp retainer, a three-point chin strap, and is fully adjustable to adapt to any situation. [pg 126](#) ▶



FULL BODY HARNESS 101

DONNING THE HARNESS

1 UNTANGLE AND VISUALLY CHECK HARNESS
Grab the harness by the dorsal D-ring and follow the chest strap to untangle. Closely look over the harness webbing for abrasion, the hardware for excessive wear, and the impact indicators to ensure it hasn't been in a fall.

2 DON THE HARNESS
Put your arms through the shoulder straps, like a jacket. Don't secure the chest strap yet.

3 ADJUST FROM THE BOTTOM UP
The sub pelvic strap should rest just below your buttocks. Raise or lower this using torso adjusters, usually above the waist belt.

4 CONNECT & ADJUST LEG STRAPS
These should be snug, but not overly tight. You should be able to slide 2 or 3 fingers between your leg and the strap.

5 CONNECT & ADJUST CHEST STRAP & WAIST BELT
Waist belt should be snug, but not too tight or too loose. The chest strap should rest directly across your chest cavity. Not too high, not too low, but right in the sweet spot to keep you safe.

TYPES OF CONNECTORS

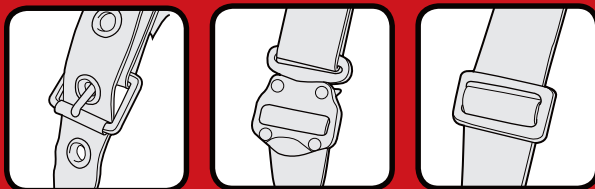

TONGUE BUCKLES
Easy operation, cannot slip once in position.

QUICK-CONNECT
Easiest operation, but can occasionally require readjustment.

PASS-THRU/MATING
Cheapest options, hardest to use and adjust properly.

DORSAL CONNECTION
This D-Ring is found on all ANSI harnesses. It's used for fall arrest and should be placed directly between the shoulder blades.

CHEST STRAP
Tower harnesses have another D-Ring here. It's the only other connection point which can be used for fall arrest, like on a cable climb system. Unlike the Dorsal D, fall distance must be limited to 2 feet or less.

WORK POSITIONING
Side D-rings are used for work positioning. Never fall arrest.

SEAT SLING
A seat is a common feature on tower harnesses, and if you're working in suspension, you'll be glad you have one. Look for features like additional tool loops or aluminum reinforcement. D-Rings can be connected using a spreader bar.

INSPECTING THE HARNESS

Visually inspect these key areas of the harness every time, prior to beginning work. If you find any of these problems, take the harness out of service.

WEBBING
Cuts, tears, excess abrasion, holes, discoloration, UV damage, heat damage, welding slag, chemical damage, hard spots

STITCHING
Damaged stitching, broken thread, pulls and loose stitches, missing sections

D-RINGS, HARDWARE, & BUCKLES
Deformity, corrosion and rust, major nicks and dings, excess wear, proper operation

IMPACT INDICATORS
Deployed impact indicators, broken D-ring plates, deformed grommets

LABELS
Manufacturer, date of manufacture, inspection log, model, series, warnings

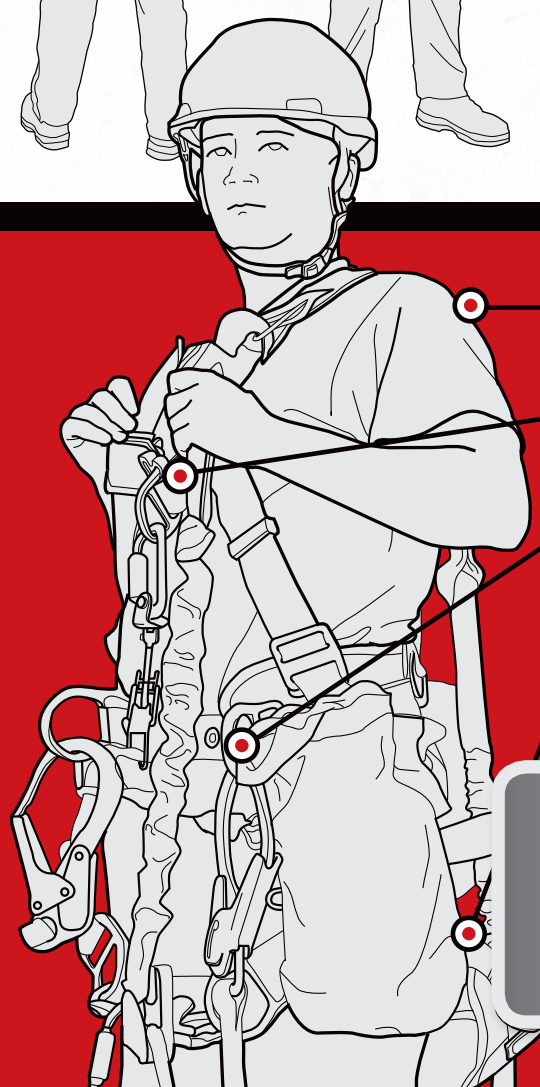

PURCHASE THE
19" x 27" POSTER FOR

\$4.99

PART # 2201

ABCDs OF FALL PROTECTION

A typical fall arrest system has four main components, often described as the ABCD's of fall protection.

Anchorage. Body Support. Connectors. Descent & Rescue.

When used properly together, they provide the maximum degree of safety for a worker at height. But don't forget, a rescue plan is an equally important factor when it comes to fall protection. The proper gear for descent and rescue should always be a part of a complete fall protection plan, too.

FREE
DOWNLOAD

VIDEO

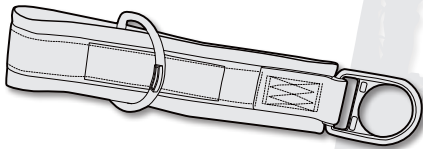

ANCHORAGE

Anchors provide secure attachment points for workers. There are many different ways to properly anchor depending on the industry, job, and structure. If you're on a tower, an anchorage point could be a tie-off sling, or perhaps an I-Beam anchor could be used in a horizontal system. Look for anchorage points rated for at least 5,000 pounds or even an engineered solution designed for your specific application. See the variety of anchorage options available starting on [page 45](#).

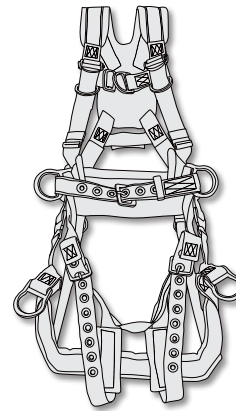

BODY SUPPORT

Now we're talking harnesses. There's no safe and natural way to attach one's body to a structure. Luckily, harnesses are designed to distribute the forces that occur in a fall to limit injuries, or worse, death. There are many varieties of harnesses available for different industries and jobs. Find the correct one for your application starting on [page 8](#).



CONNECTORS

Once you've chosen a comfortable harness and your anchor point is secure, you just need one last thing before you're ready to climb. Here's where a shock absorbing lanyard or SRL comes in. Twin-leg lanyards provide 100% tie-off. SRL's can limit your fall distance to a few inches. Again, there are a variety of connectors to choose from, made by many different manufacturers. See them all beginning on [page 26](#).

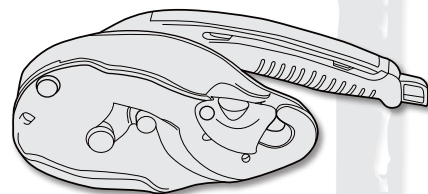

DESCENT & RESCUE

What's your plan? Every job site needs to have proper rescue equipment and a proper rescue plan in place before anyone starts working. From rope access to confined space, there is specific gear needed to get to a fallen worker and get them to safety. A haul system helps raise them up, and a descent device will lower them down. Or maybe you could add trauma straps to your harness, so if you're the one dangling you can relieve some of the pressure that gravity is placing on your parts. Lucky for you, our Gear Experts® have put together some rescue kits that can get you started on your rescue solution. Take a look starting on [page 64](#).

FALL PROTECTION ESSENTIALS

Peregrine RAS Platinum Tower Climbing Harness

Elk River has been an innovator of tower products for many years. The lightweight Peregrine RAS features an adjustable and removable aluminum bar seat. It's known as one of the most comfortable harnesses on the market, due to its aluminum D-rings and breathable padding. It's versatile with multiple tool rings and extra grommets on belt and leg straps for perfect fit.

Flex-NoPac Shock Absorbing Lanyard

This twin leg lanyard features 6' legs with a 2-1/4" double-locking rebar hook at each end and a 3/4" centurion auto-lock snaphook in the middle. This lanyard is one of the most popular lanyards in the industry.

 **Elk River**
Personal Fall Protection

PERFORMANCE-DESIGNED SAFETY PRODUCTS

WWW.ELKRIVER.COM





GO TO WWW.GMESUPPLY.COM/HARNESSES
TO VIEW ALL HARNESSES

SIZING
CHART
ONLINE



Elk River

ELK RIVER PEREGRINE RAS PLATINUM TOWER CLIMBING HARNESSES

WEIGHT	8.7 lbs	●●●○
LEG STRAPS	QC TB MT	
CHEST STRAPS	QC TB MT	
PADDING		
FEATURES		

Elk River based this harness on their popular Peregrine platform. Users that want a lightweight harness that is easily adjusted for a great fit will appreciate the harness. The removable and adjustable seat is just an added bonus.

ALUMINUM D-RINGS (8.7 lbs)

67632 - \$557.91

STEEL D-RINGS (8.8 lbs)

67642 - \$557.91



GEAR EXPERTS®

“ The Platinum RAS is the most advanced harness in Elk River's Peregrine line, with a removable and adjustable seat (where RAS comes from). My customers are looking for a consistent and secure fit, and this harness delivers. The tongue/buckle leg straps and locking quick connect chest strap ensure that this harness is comfortable when you put it on and doesn't work its way loose. Aluminum hardware keeps the harness as one of the lightest in its class, and the removable seat allows you to shave a couple of pounds when you don't need to use it. The padding is breathable from the leg straps to your shoulders which may not be as important in the Great Lakes or Canada, but my partners in the Southeast are looking for anything to help keep them from being weighed down by a sweat soaked harness. ”



TYLER NELSON

Southeast Regional Sales Manager



ELK RIVER TRAUMA RELIEF STRAP

Helps prevent suspension trauma after a fall. In the event of a fall, the trauma strap allows the worker to assume a standing position to avoid suspension trauma. The Trauma Strap relieves pressure on the lower extremities, allows better blood flow, and reduces fatigue. 1" Polyester web, nylon case. Hook and cambuckle for adjustable loop length. Compact and lightweight.

85007 - \$22.13



ELK RIVER PEREGRINE PLATINUM TOWER CLIMBING HARNESSES

WEIGHT	8.3 lbs	●●●○
CHEST STRAPS	QC TB MT	
PADDING		
FEATURES		

This harness has a unique construction with the leg straps sewn into the seat rather than a sub-pelvic support. Those that love this harness end up loving it forever.

LEG STRAPS QC TB MT

67602 8.7 lbs - \$531.65

LEG STRAPS QC TB MT

67612 8.7 lbs - \$462.48



ELK RIVER RAVEN TOWER CLIMBING HARNESSES

WEIGHT	8.3 lbs	●●●○
LEG STRAPS	QC TB MT	
CHEST STRAPS	QC TB MT	
PADDING		
FEATURES		

The Raven is Elk River's newest harness. Streamlined gel-type padding help give the harness a low profile and light weight.

67662 - \$600.83



ELK RIVER EAGLETOWER HARNESSES

WEIGHT	8.8 lbs	●●●○
LEG STRAPS	QC TB MT	
CHEST STRAPS	QC TB MT	
PADDING		
FEATURES		

The Eagle has been popular for years, and continues to be a popular choice for those prioritizing cost and durability. We recommend the 6662 series for additional support in the seat.

NO BAR IN SEAT (8.8 lbs)

66612 - \$286.72

ALUMINUM BAR IN SEAT (9.1 lbs)

66622 - \$326.57



INNOVATION IN FALL PROTECTION



**BLACKMAX
SHOCK
ABSORBING
LANYARD**

**ASCEND TOWER
CLIMBING HARNESS**

The Ascend Tower Climbing Harness was designed by industry experts with comfort in mind. This premium harness is affordable and built for all day comfort.

The BlackMax Shock Absorbing Lanyard was built with tower climbers in mind. It can be used in both standard, and extended free fall situations.

**WESTFALL
PRO**

573-355-5470 | WWW.WESTFALLPRO.COM

**WESTFALL PRO
ALUMINUM ASCEND
TOWER CLIMBING
HARNESSES**

SIZING
CHART
ONLINE

QUICK SHIP

VIDEO

ALUMINUM
HARDWARE



WEIGHT	9.9 lbs	●●●○	
LEG STRAPS	QC	TB	MT
CHEST STRAPS	QC	TB	MT
PADDING	-----		
FEATURES	-----		

Sewn-in hip pad with removable tool belt. Large adjustable seat for easy positioning. Extra utility attachment loops.

88022 - \$409.99



**WESTFALL PRO
STEEL ASCEND
TOWER CLIMBING
HARNESSES**

QUICK SHIP

VIDEO

STEEL
HARDWARE



WEIGHT	11.2 lbs	●●●●●	
LEG STRAPS	QC	TB	MT
CHEST STRAPS	QC	TB	MT
PADDING	-----		
FEATURES	-----		

Sewn-in hip pad with removable tool belt. Large adjustable seat for easy positioning. Extra utility attachment loops.

88012 - \$324.99



**SKYLOTEC IGNITE
PROTON TOWER
HARNESSES**

WEIGHT 9.4 lbs ●●●●○

LEG STRAPS	QC	TB	MT
CHEST STRAPS	QC	TB	MT
PADDING	-----		
FEATURES	-----		

6-point adjustment with removable tool belt. Added benefit of a lightweight, rigid aluminum removable positioning/suspension saddle. Air pad technology.

G-1132-T - \$595.00



**FALLTECH COMFORTECH
TOWER CLIMBING
HARNESSES**

QUICK SHIP

VIDEO

WEIGHT	10.9 lbs	●●●●●	
LEG STRAPS	QC	TB	MT
CHEST STRAPS	QC	TB	MT
PADDING	-----		
FEATURES	-----		

New improved Comfortech padding, wide comfortable seat, steel hardware, and 5-point adjustability.

7084 - \$424.99





SIZING CHART ONLINE



DBI SALA EXOFIT STRATA TOWER CLIMBING HARNESS

WEIGHT	12.5 lbs	●●●●○	
CHEST STRAPS	QC	TB	MT
PADDING	-----		
FEATURES	-----		

LIFTech weight distribution system. PolarMesh back pad. EZ-Link SRL adapter. Stand-up Tech-Lite dorsal D-ring. Repel webbing, built-in lanyard keepers that automatically reset. Revolver torso and leg strap adjusters. Integrated trauma straps.

LEG STRAPS	QC	TB	MT
------------	----	----	----

1112581 12.5 lbs - \$899.99

LEG STRAPS	QC	TB	MT
------------	----	----	----

1112586 11.9 lbs - \$824.99



SEE TOOL POUCHES ON PAGE 119



PETZL VOLT INTERNATIONAL VERSION

WEIGHT	5.2 lbs	●●●○	
LEG STRAPS	QC	TB	MT
CHEST STRAPS	QC	TB	MT
PADDING	-----		
FEATURES	-----		

Developed to meet both American and European standards. Semi-rigid waistbelt and leg loops for all-day comfort. Breathable construction maximizes airflow to keep you cool.

C072CA00 - \$299.95



GME SUPPLY LARGE UTILITY CANVAS POUCH WITH LEATHER BOTTOM

Large Utility Bag is 9" tall, 10" wide and has a top diameter of 8"x3". Features a leather bottom for durability with a ventilation eyelet. Attaches via snaphooks on the back.

5142P - \$27.99



DBI SALA TOOL BAG HANGER FOR EXOFIT STRATA HARNESS

Hanger threads through most tool bags and pouches, keeping them in place on your harness. Made from aluminum, lightweight and pivots for easy installation. Bag not included.

9512724 - \$19.99



PETZL TOOLBAG TOOL POUCH

Constructed of durable material with a drawstring top closure for safety and security. Water resistant. Attaches to any type of harness.

S47YS 6.75" H (2.5 liters) - \$29.95

P42 Standard clip - \$8.95

S47YL 11" H (5 liters) - \$39.95

P42L Large clip - \$18.95

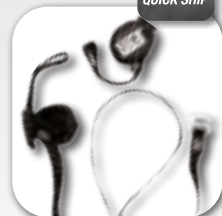

DBI SALA SUSPENSION TRAUMA SAFETY STRAPS

Deploy when needed and hook together in seconds, allows suspended worker to stand up in harness and relieve downward pressure, continuous loop design allows for one-foot or two-foot suspension. Connects to most harnesses, one pair.

9501403 - \$33.99



FRENCH CREEK STRATOS TOWER CLIMBING HARNESS

WEIGHT	8.0 lbs	●●●●○	
LEG STRAPS	QC	TB	MT
CHEST STRAPS	QC	TB	MT
PADDING	-----		
FEATURES	-----		

6-point adjustment with removable tool belt. Added benefit of a lightweight, rigid aluminum removable positioning/suspension saddle.

22850BH-ALT - \$249.95



FALLTECH JOURNEYMAN TOWER CLIMBING HARNESS

WEIGHT	7.0 lbs	●●●○	
LEG STRAPS	QC	TB	MT
CHEST STRAPS	QC	TB	MT
PADDING	-----		
FEATURES	-----		

6 Steel D-Rings. Padded dorsal D-ring and shoulder assembly. 6" waist pad/positioning assembly. 5" padded seat sling for prolonged work positioning. Twin torso keepers for stowing idle lanyard connectors. Forged alloy steel hardware.

7042 - \$277.99





Fall Protection



SIZING CHART ONLINE

SEE TRAUMA STRAPS ON PAGE 25

HARNESSES // TOWER CLIMBING

DBI SALA EXOFIT TOWER CLIMBING HARNESS

WEIGHT	9.5 lbs	●●●●○	
LEG STRAPS	QC	TB	MT
CHEST STRAPS	QC	TB	MT
PADDING			
FEATURES			

The standard ExoFit offers the comfort and reliability tower climbers expect from DBI Sala. This model includes quick connect leg straps and parachute torso adjusters.

1108651 - \$499.99



DBI SALA EXOFIT NEX TOWER CLIMBING HARNESS

WEIGHT	9.8 lbs	●●●●○	
LEG STRAPS	QC	TB	MT
CHEST STRAPS	QC	TB	MT
PADDING			
FEATURES			

The NEX pairs comfort with high-end features like the Stand-up Tech-Lite aluminum dorsal d-ring, rigid waist belt, revolver torso adjusters, and integrated trauma straps.

1113191 - \$649.99



DBI SALA EXOFIT TOWER CLIMBING HARNESS

WEIGHT	9.0 lbs	●●●●○	
LEG STRAPS	QC	TB	MT
CHEST STRAPS	QC	TB	MT
PADDING			
FEATURES			

A variation of the standard ExoFit, this model uses tongue-buckle leg straps which may require less adjustment during the work day.

1110526 - \$539.99

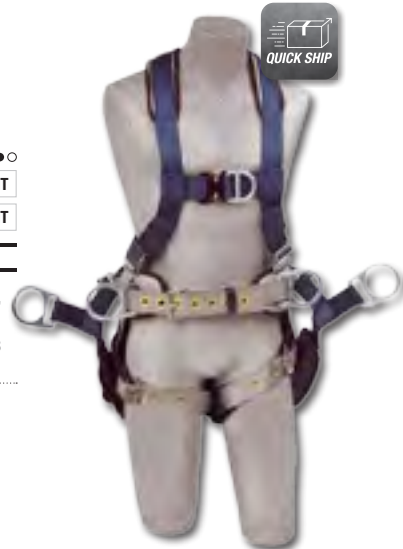

DBI SALA EXOFIT XP TOWER CLIMBING HARNESS

WEIGHT	10.2 lbs	●●●●○	
LEG STRAPS	QC	TB	MT
CHEST STRAPS	QC	TB	MT
PADDING			
FEATURES			

The ExoFit XP is a step up in comfort with additional padding from the standard ExoFit. The upgraded, removable padding is washable for extended harness life.

1110301 - \$574.99



DBI SALA EXOFIT NEX TOWER CLIMBING HARNESS

WEIGHT	9.8 lbs	●●●●○	
LEG STRAPS	QC	TB	MT
CHEST STRAPS	QC	TB	MT
PADDING			
FEATURES			

This NEX harness features tongue buckle leg straps which may reduce the amount of adjustment required when donning, and working in the ExoFit harness.

1113376 - \$717.99



KITS
SAVE
CASH



QUICK SHIP

GME SUPPLY EXOFIT TOWER CLIMBING KIT

Kit includes DBI Sala ExoFit Tower Climbing Harness, SafeWaze V-Line 6' Dual-Leg Lanyard, Petzl Vertex Vent Helmet, Petzl Grillon ANSI Positioning Lanyard, WestFall Pro Separator Snaphook, DBI Sala 3/8" Cable Safety Sleeve with Carabiner, (2) 4-1/2" x 2-3/4" Steel Carabiners, (2) 4-7/8" x 3" Steel Carabiners, (2) GME Supply Premium Top-Closing Nylon Bolt Bags. Helmet color options: white, red, yellow, blue, black, orange, and hi-viz yellow.

Upgrades available: GME Supply Deluxe Gear Bag (+\$55.00), GME Supply Premium Gear Bag (+\$75.00).

90006 - \$1,386.99

QUICK SHIP

VIDEO



GME SUPPLY PEREGRINE TOWER CLIMBING KIT

Kit includes Elk River Peregrine RAS Platinum Tower Climbing Harness, SafeWaze V-Line 6' Dual-Leg Lanyard, Petzl Vertex Vent Helmet, Petzl Grillon ANSI Positioning Lanyard, WestFall Pro Separator Snaphook, DBI Sala 3/8" Cable Safety Sleeve with Carabiner, (2) 4-1/2" x 2-3/4" Steel Carabiners, (2) 4-7/8" x 3" Steel Carabiners, (2) GME Supply Premium Top-Closing Nylon Bolt Bags. Helmet color options: white, red, yellow, blue, black, orange, and hi-viz yellow.

Upgrades available: GME Supply Deluxe Gear Bag (+\$55.00), GME Supply Premium Gear Bag (+\$75.00).

90019 - \$1,299.99

QUICK SHIP



GME SUPPLY WESTFALL PRO TOWER CLIMBING KIT

Kit includes WestFall Pro Ascend Steel Tower Climbing Harness, SafeWaze V-Line 6' Dual-Leg Lanyard, Evo 6151 Vent Helmet, Petzl Grillon ANSI Positioning Lanyard, WestFall Pro Separator Snaphook, DBI Sala 3/8" Cable Safety Sleeve with Carabiner, (2) 4-1/2" x 2-3/4" Steel Carabiners, (2) 4-7/8" x 3" Steel Carabiners, (2) GME Supply Premium Top-Closing Nylon Bolt Bags. Helmet color options: white, red, yellow, blue, black, orange, and hi-viz yellow.

Upgrades available: Aluminum Hardware on Harness (+\$75.00), Petzl Vertex Vent Helmet (+\$115.00), GME Supply Deluxe Gear Bag (+\$55.00), GME Supply Premium Gear Bag (+\$75.00).

90007 - \$1,027.99

VIDEO



GME SUPPLY COMPLETE TOWER CLIMBING KIT

Kit includes Elk River EagleTower LE Tower Climbing Harness, Safety Helmet, Elk River 6' Adjustable Web Lanyard, SafeWaze V-Line 6' Dual-Leg Lanyard, WestFall Pro Separator Snaphook, (2) 4" x 2" Steel Carabiners, (2) 7" x 3-3/4" Steel Carabiners, Tuf-Tug 3/8" Cable Safety Sleeve, GME Supply Premium Top-Closing Nylon Bolt Bag, GME Supply Deluxe Gear Bag.

Upgrades available: Elk River Peregrine Platinum Tower Climbing Harness (+\$150.00), Petzl Vertex Vent Helmet (+\$115.00), Evo 6151 Vent Helmet (+\$35.00), DBI Sala X3 3/8" Cable Safety Sleeve with Carabiner (+\$220.00), GME Supply Premium Gear Bag (+\$20.00).

90002 - \$827.99

PERSONAL FINANCING AVAILABLE : 6 MONTHS, 0% INTEREST

For details visit www.gmesupply.com/personal-financing or call 800-940-6762



GME SUPPLY PETZL TOWER CLIMBING KIT

Kit includes Petzl Volt Tower Climbing Harness with seat, Absorbica-Y 6' Double Leg Lanyard, Grillon ANSI Positioning Lanyard, Small Tool Bag, Large Tool Bag, Small Caritool, Large Caritool, Vertex Vent Helmet (choose color), (2) 4-7/8" x 3" Steel Carabiners, WestFall Pro Separator Snaphook.

Upgrades available: GME Supply Deluxe Gear Bag (+\$55.00), GME Supply Premium Gear Bag (+\$75.00), DBI Sala X3 3/8" Cable Safety Sleeve with Carabiner (+\$370.00).

90017 - \$1,089.99



GME SUPPLY EXOFIT NEX TOWER CLIMBING KIT

Kit includes DBI Sala ExoFit NEX Tower Climbing Harness, Petzl Grillon ANSI Positioning Lanyard, SafeWaze V-Line 6' Dual-Leg Lanyard, Petzl Vertex Vent Helmet, GME Supply Premium Top-Closing Nylon Bolt Bag, WestFall Pro Separator Snaphook, (2) 4-7/8" x 3" Steel Carabiners, 9" x 5-1/2" Steel Carabiner.

Upgrades available: GME Supply Deluxe Gear Bag (+\$55.00), GME Supply Premium Gear Bag (+\$75.00), DBI Sala X3 3/8" Cable Safety Sleeve with Carabiner (+\$370.00).

90005 - \$942.99



GME SUPPLY FALLTECH TOWER CLIMBING KIT

Kit includes FallTech ComforTech Tower Climbing Harness, SafeWaze V-Line 6' Dual-Leg Lanyard, Guardian Adjustable Positioning Web Lanyard, WestFall Pro Separator Snaphook, GME Supply Premium Top-Closing Nylon Bolt Bag.

Upgrades available: Petzl Vertex Vent Helmet (+\$115.00), Evo 6151 Vent Helmet (+\$35.00), GME Supply Deluxe Gear Bag (+\$55.00), GME Supply Premium Gear Bag (+\$75.00), DBI Sala X3 3/8" Cable Safety Sleeve with Carabiner (+\$370.00).

90004 - \$512.99



GME SUPPLY BASIC TOWER CLIMBING KIT

Kit includes Elk River EagleTower LE Tower Climbing Harness, SafeWaze V-Line 6' Dual-Leg Lanyard, Guardian Adjustable Positioning Web Lanyard, WestFall Pro Separator Snaphook.

Upgrades available: Elk River Peregrine Platinum Tower Climbing Harness (+\$150.00), Petzl Vertex Vent Helmet (+\$115.00), Evo 6151 Vent Helmet (+\$35.00), Construction Helmet (+\$8.75), GME Supply Deluxe Gear Bag (+\$55.00), GME Supply Premium Gear Bag (+\$75.00), GME Supply Top-Closing Bolt Bag (+\$23.00).

90000 - \$379.99



ADD FIELDSENSE 2.0 RF MONITOR TO ANY TOWER CLIMBING KIT FOR A DISCOUNTED PRICE

~~\$599.99~~
\$575.00



BUILD YOUR OWN TOWER CLIMBING KIT

START WITH THE BASICS \$428.00 | PART NUMBER: 90099



Elk River EagleTower LE Harness



SafeWaze V-Line Dual-Leg Lanyard



Guardian Adjustable Positioning Web Lanyard



JSP Comfort Plus Type 1 Hard Hat

KITS
SAVE
CASH



VIDEO

CHOOSE YOUR DISCOUNTED UPGRADES (MORE OPTIONS ONLINE)



Elk River Peregrine Platinum Tower Harness +\$140⁰⁰



WestFall Pro Ascend Tower Harness (Aluminum) +\$149⁰⁰



DBI Sala ExoFit Tower Harness +\$138⁰⁰



DBI Sala Strata Tower Harness +\$500⁰⁰



FallTech Aluminum Shock Absorbing Lanyard +\$29⁰⁰



WestFall Pro Shock Absorbing Lanyard +\$10⁰⁰



Kong Trimmer Adjustable 2 m Positioning Lanyard +\$132⁰⁰



Petzl Grillon Adjustable 2 m Positioning Lanyard +\$146⁰⁰



Petzl Vertex Vent Helmet +\$115⁰⁰



JSP Deluxe Wheel Ratchet Helmet +\$35⁰⁰



DBI Sala Lad-Saf X3 Cable Safety Sleeve +\$430⁰⁰



Miller Vi-Go Cable Safety Sleeve +\$402⁰⁰



Skylotec Claw Cable Safety Sleeve +\$390⁰⁰

CHOOSE YOUR PACKAGES



Bag Package: GME Supply Deluxe Gear Bag & (2) GME Supply Premium Top-Closing Nylon Bolt Bags +\$112⁰⁰



Connector Package: Separator Snaphook, (2) 4-7/8" x 3" Steel Carabiners, & (2) 7" x 3-3/4" Steel Carabiners +\$118⁰⁰



Accessory Package: Elk River Radio Holster, (2) Ergodyne Squids Tool Lanyards, & (2) FallTech 3' Anchor Straps +\$69⁰⁰

AVAILABLE EXCLUSIVELY AT GME SUPPLY www.gmesupply.com/build-a-kit | (800) 940-6762



© 2019 Petzl Distribution - James Rice

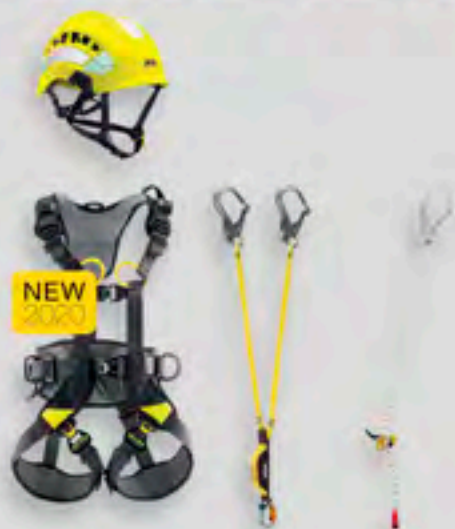

A work solution for tower climbers that includes a VERTEX VENT HI-VIZ helmet, a VOLT harness, an ABSORBICA-Y fall arrest lanyard, and a GRILLON MGO work positioning lanyard.
www.petzl.com

PETZL TOWER SOLUTIONS

Working on towers requires specific skills and having the right equipment, Petzl puts all of its expertise into providing you with the best possible equipment. Here's a look at the EasTex Tower team doing maintenance on an alpine tower in Colorado Springs, Colorado.



Access
the
inaccessible®



PROTECTA COMFORT VEST-STYLE HARNESS

WEIGHT	3.4 lbs ●●●○
LEG STRAPS	QC TB MT
CHEST STRAPS	QC TB MT
PADDING	+
FEATURES	+

Breathable back padding with soft edging for added comfort.

1161418 - \$89.99



WESTFALL PRO STEELHORSE HARNESS

WEIGHT	4.0 lbs ●●●○
LEG STRAPS	QC TB MT
CHEST STRAPS	QC TB MT
PADDING	+
FEATURES	+

Pad/belt assembly can be removed for versatility.

840000 - \$109.99



GUARDIAN SERAPH HARNESS

WEIGHT	3.5 lbs ●●●○
CHEST STRAPS	QC TB MT
PADDING	+
FEATURES	+

Quick adjust torso buckles. Break-away lanyard keepers.

LEG STRAPS	QC TB MT
------------	----------

11164 3.5 lbs - \$89.99

LEG STRAPS	QC TB MT
------------	----------

11160 3.1 lbs - \$54.99



GUARDIAN VELOCITY HARNESS

WEIGHT	3.2 lbs ●●●○
LEG STRAPS	QC TB MT
CHEST STRAPS	QC TB MT
PADDING	+
FEATURES	+

Break away lanyard keepers. Identification label. Finished webbing ends. Webbing 'wear' indicator.

01703 3.2 lbs - \$44.99

LEG STRAPS	QC TB MT
------------	----------

01700 4.0 lbs - \$42.99



FALLTECH ADVANCED COMFOTECH GEL HARNESS

WEIGHT	4.0 lbs ●●●○
LEG STRAPS	QC TB MT
CHEST STRAPS	QC TB MT
PADDING	+
FEATURES	+

Polymer gels in the shoulder and waist pads for added support and cushioning in key areas

7080B - \$229.60



DELTA VEST STYLE HARNESS

WEIGHT	4.4 lbs ●●●○
LEG STRAPS	QC TB MT
CHEST STRAPS	QC TB MT
PADDING	+
FEATURES	+

Water repellent webbing. Lanyard parks. Vertical torso adjuster.

1102000 Without side D-rings (4.0 lbs) - \$127.99

1102008 With side D-rings (4.4 lbs) - \$144.99



REAL GEAR FOR REAL WORK

Made in the
USA

STRATOS Series
Full Body Tower
Climbing Harnesses



Model#: 22850BH-ALT

Providing a full line of fall protection/rescue equipment



FrenchCreek
FALL SAFETY

877.228.9327

frenchcreekproduction.com



**GUARDIAN SERAPH
CONSTRUCTION
HARNESSES**

WEIGHT	5.6 lbs	●●●○	
LEG STRAPS	QC	TB	MT
CHEST STRAPS	QC	TB	MT
PADDING	-----		
FEATURES	-----		

Hammer loops, web keepers, and lanyard keepers. Improved elasticity in the shoulder and back.

11173 - \$90.00

GEAR EXPERTS®

“If you’re looking for a reliable, basic, and extremely functional harness this is your first and last stop. This harness does not sacrifice comfort and versatility despite its economical price. Elasticity is woven into the shoulders and back to make sure you can get around without being constricted by static webbing. It’s light, the tongue buckle legs make sure you have a consistent fit through the life of the harness, and the rescue d rings on the shoulders make confined space work that much easier. No frills, no fuss, just a comfortable and reliable harness.”



BRYAN DOMINIQUE
Northeast Regional Sales Manager



**GUARDIAN
CYCLONE
HARNESSES**

WEIGHT	4.5 lbs	●●○○	
LEG STRAPS	QC	TB	MT
CHEST STRAPS	QC	TB	MT
PADDING	-----		
FEATURES	-----		

Padded tool belt. Break-away lanyard keepers. Superior flexibility and comfort.

21030 - \$160.99



**FRENCH CREEK
STRATOS TOWER
CLIMBING HARNESSES**

WEIGHT	5.0 lbs	●●●○	
LEG STRAPS	QC	TB	MT
CHEST STRAPS	QC	TB	MT
PADDING	-----		
FEATURES	-----		

Strato-lite comfort shoulder/back pad and leg pads permanently affixed to keep them in the ideal position.

22850BH-ALT - \$249.95



**FALLTECH
CONTRACTOR
HARNESSES**

WEIGHT	4.0 lbs	●●○○	
LEG STRAPS	QC	TB	MT
CHEST STRAPS	QC	TB	MT
PADDING	-----		
FEATURES	-----		

Torso keeper for stowing idle lanyard connector.

7018 - \$56.99



**GUARDIAN SERAPH
HARNESSES**

WEIGHT	4.1 lbs	●●○○	
LEG STRAPS	QC	TB	MT
CHEST STRAPS	QC	TB	MT
PADDING	-----		
FEATURES	-----		

Break-away lanyard keepers. Superior flexibility and comfort.

11165 - \$79.99





DBI SALA EXOFIT CONSTRUCTION HARNESS

WEIGHT	6.4 lbs	●●●●○	
LEG STRAPS	QC	TB	MT
CHEST STRAPS	QC	TB	MT
PADDING	-----		
FEATURES	-----		

Anti-tear ballistic nylon. Built-in reflective piping. Protected labels.

1110476 - \$349.99



DBI SALA EXOFIT NEX CONSTRUCTION HARNESS

WEIGHT	6.4 lbs	●●●●○	
LEG STRAPS	QC	TB	MT
CHEST STRAPS	QC	TB	MT
PADDING	-----		
FEATURES	-----		

Protective shoulder caps. Integrated trauma straps.

WITHOUT CHEST D-RING (6.4 lbs)

1113124 - \$431.99

WITH CHEST D-RING (6.6 lbs)

1113154 - \$472.99



DBI SALA EXOFIT CONSTRUCTION HARNESS

WEIGHT	5.8 lbs	●●●●○	
LEG STRAPS	QC	TB	MT
CHEST STRAPS	QC	TB	MT
PADDING	-----		
FEATURES	-----		

Soft and lightweight webbing. Built-in reflective piping.

1108501 - \$361.99



MILLER AIRCORE HARNESS

WEIGHT	6.0 lbs	●●●●○	
CHEST STRAPS	QC	TB	MT
PADDING	-----		
FEATURES	-----		

DuraFlex webbing. Removable belt with padding.

AC-QC-BDP/UGN 6.1 lbs

- \$299.99

AC-TB-BDP/UGN 6.1 lbs

- \$299.99



PROTECTA CONSTRUCTION STYLE HARNESS

WEIGHT	5.3 lbs	●●●○	
LEG STRAPS	QC	TB	MT
CHEST STRAPS	QC	TB	MT
PADDING	-----		
FEATURES	-----		

Fixed D-ring reduces the need for readjustment throughout the workday. Moisture-wicking, breathable back padding with soft edging and foam hip pad for added comfort. Auto-resetting lanyard keepers.

1161309 - \$99.99



PROTECTA COMFORT CONSTRUCTION STYLE HARNESS

WEIGHT	5.6 lbs	●●●○	
LEG STRAPS	QC	TB	MT
CHEST STRAPS	QC	TB	MT
PADDING	-----		
FEATURES	-----		

Easy-link web adapter enables fast and easy attachment of personal self-retracting lifelines and keeps the D-ring available. Moisture-wicking, breathable back padding with soft edging and foam hip pad for added comfort. Auto-resetting lanyard keepers.

1161205 - \$104.99





PETZL AVAO BOD HARNESS

WEIGHT	5.1 lbs	●●○○○
CHEST STRAPS	QC	TB MT
PADDING	-----	
FEATURES	-----	

X-Shaped dorsal construction reduces pressure points fastened with a triact-lock automatic locking carabiner. Semi-rigid wide waist belt and leg loops for positioning. Fold-away side attachment points. (6) equipment loops on the sides and rear. (4) caritool tool holder retainers. Can be paired with Petzl Podium Seat.

LEG STRAPS	QC	TB	MT
------------	----	----	----

C71AAA 5.1 lbs, color - \$399.95

LEG STRAPS	QC	TB	MT
------------	----	----	----

C71AFA 5.3 lbs, color - \$449.95

LEG STRAPS	QC	TB	MT
------------	----	----	----

C71AFN 5.4 lbs, black-out color - \$479.95



* Petzl harness sizing tip, call our Gear Experts® for more information.

Size 0 is fitted for waist sizes smaller than 31.5", a majority of climbers fall in the waist range for Size 1.



PETZL AVAO BOD CROLL FAST HARNESS

WEIGHT	5.7 lbs	●●●○○
LEG STRAPS	QC	TB MT
CHEST STRAPS	QC	TB MT
PADDING	-----	
FEATURES	-----	

X-Shaped dorsal construction reduces pressure points, integrated croll ventral rope clamp for ascending ropes. Semi-rigid, wide waist belt and leg loops. Fold-away side attachment points. (6) equipment loops on the sides and rear. (4) caritool tool holder retainers. (2) slots for tool bag tool pouch.

C71CFA 5.7 lbs, color - \$499.95

C71CFN 5.7 lbs, black-out color - \$519.95



PETZL PODIUM WORK SEAT

2.9 lbs. This work seat provides optimal comfort during prolonged suspension. This seat has a wide sitting position for excellent stability and the rigid sides prevent the webbing straps from cutting into your thighs. Has two equipment loops and a rear hook, making it easier to store in order to facilitate movement.

S071AA00 - \$219.95



DBI SALA EXOFIT NEX BLACK-OUT ROPE ACCESS & RESCUE HARNESS

WEIGHT	5.5 lbs	●●●○○
LEG STRAPS	QC	TB MT
CHEST STRAPS	QC	TB MT
PADDING	-----	
FEATURES	-----	

Ultra-soft edging and water-repellent webbing.

1113371 5.5 lbs, black-out - \$419.99

1113346 5.5 lbs, color - \$403.99



SKYLOTEC RESCUE PRO 2.0 HIGHLINE HARNESS

WEIGHT	6.5 lbs	●●●○○
LEG STRAPS	QC	TB MT
CHEST STRAPS	QC	TB MT
PADDING	-----	
FEATURES	-----	

Features a V-shaped back construction. Multiple adjustment points makes this harness comfortable. Material loops and tool eyelets are located on the leg pads.

G-1101 - \$515.00

SUSPENSION TRAUMA 101

Prompt rescue is critical in the event of fall. In just minutes, suspension trauma can set in and cause serious, potentially fatal damage. It's caused when blood pools in your legs. Your heart is still pumping blood to your legs, and when you cannot use your skeletal muscles to help "pump" that blood back, gravity causes it to pool in your feet and legs. Your harness putting pressure on important veins and arteries also makes circulation difficult. This pooling deprives the brain, kidneys, and other vital organs of oxygen. Suspension trauma straps are a simple accessory to help relieve pressure off of the harness leg straps.

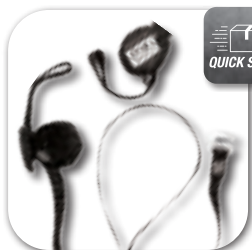

DBI SALA SUSPENSION TRAUMA SAFETY STRAPS

Deploy when needed and hook together in seconds, allows suspended worker to stand up in harness and relieve downward pressure, continuous loop design allows for one-foot or two-foot suspension. Connects to most harnesses, one pair.

9501403 - \$33.99



GME SUPPLY CARABINER VARIETY PACK

Buy in bulk and save, pack of 10 includes our most popular carabiners:

- (4) 4-7/8" x 3" carabiners;
- (2) 4-1/2" x 2-3/4" carabiners;
- (2) 7" x 3-3/4" carabiners;
- (2) 7" x 4-1/2" carabiners.

CARABINERPACK - \$249.99



GME SUPPLY CONNECTOR PACKAGE

Add-on to this package to easily get all the carabiners and hardware you need to go along with your tower climbing gear. Package includes WestFall Pro Separator Snaphook, (2) WestFall Pro 4-7/8" x 3" carabiners, and (2) WestFall Pro 7" x 3-3/4" carabiners.

90110 - \$134.99



T-REIGN PROHOLSTER POUCH

Open-top protective case with a retractable tether, designed for small devices that need protection, but are ruggedly built and need to be within easy reach. Rugged, 36" Kevlar tether is strong and durable. Hook and latch closure system allows one-handed access to gear. Constructed with rugged 600 D nylon, tether cord can stretch to accommodate up to a 6" tall device. 2" W x 1.1" D.

908471 - \$29.99



SQUIDS GLOVE GRABBER,

Clips to clothing, belts, tool belts, and D-rings. Durable and detachable breakaway feature. Dielectric / non-conductive material. Available in hi-vis orange, hi-vis lime, blue, and black.

3400 - \$2.50

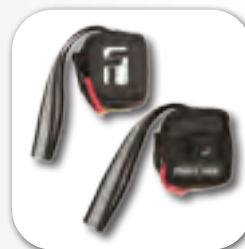

FALLTECH TRAUMA STRAPS

Set of (2) compatible hip-packs. Exclusive deployment design. Reflective webbing throughout. Fits all full body harnesses.

5040 - \$27.99



GUARDIAN TRAUMA STRAPS

Lightweight and easy to install. Compatible with all harnesses. Easy to adjust and its low profile keeps out of the way during work.

10733 - \$24.99





SKYLOTEC

CONTINUOUSLY IMPROVING WORKER SAFETY

6 FT & 12 FT

FREEFALL CERTIFIED

SKYSAFE PRO FLEX

- Reduces the impact force to below 1349 lbf. (6kN) in the range from 110 - 340 lbs
- Built in rescue loops
- Fall indicators on both legs
- Removable and replaceable protective cover



L-0558-1,8

L-0533-1,8



L-0562-1,8

NEW AND IMPROVED

CLAW

Smooth running **CLAW** Vertical Cable Sleeve for 3/8 & 5/16 inch diameter wire ropes.

MEETS ANSVASSP Z359.16



CL-001

IGNITE PROTON TOWER



G-1132-T

IGNITE PROTON WIND



G-1132-W

RESCUE PRO 2.0



G-1083-AL

LDRY PRO



L-0691

NEW SIRIUS



A-050

SKYLOTEC offers you a highly innovative and functional range of fall protection, rope access and rescue equipment. The **IGNITE PROTON TOWER**, **IGNITE PROTON WIND**, and **RESCUE PRO 2.0** Harnesses feature light-weight designs built for durability and comfort. The **LDRYPRO positioning** lanyard allows you to work hands free with complete adjustability. **SIRIUS** is our first self-locking descender specially designed for all kinds of rope-based access and rescue.

For more information please email us at info-us@skylotec.de.

skylotec.com | SKYLOTEC North America LP | Denver, CO USA | Tel 1-303-544-2120



SKYLOTEC

6 FT vs 12 FT FREE FALL

6 FT FREE FALL

A 6'
B 4'
C 6'
D 2'
=18'

12 FT FREE FALL

A 12'
B 5'
C 6'
D 2'
=25'

6 FT FREE FALL **12 FT FREE FALL** LOOK FOR THESE BADGES THROUGHOUT THE CATALOG.

CALCULATING FREE FALL

$A + B + C + D =$
TOTAL FALL CLEARANCE

A. Free fall distance
Original working length before a fall event occurs/before activation of energy absorber.

B. Deceleration distance
Maximum allowable amount of elongation that may payout from the energy absorber upon activation during a fall event.

C. Height of dorsal D-ring
Typical average height of the dorsal D-Ring on a user's full body harness measured from the walking/working surface up.

D. Harness stretch & dorsal D-ring shift + safety factor
Combined amount of harness webbing elongation and dorsal back D-ring up-shift during entire fall event.

Typical twin leg lanyards are designed to arrest the forces associated with a maximum fall distance of 6 feet. Ideally, your anchorage is above you, so a standard 6 foot lanyard that's attached to your dorsal D-ring will limit your free fall to an acceptable distance.

When you don't have an overhead anchorage, your fall distance increases. The lanyard won't begin to stop you until your lower anchorage is now above you. A standard lanyard is not designed to safely stop you while you're falling from that distance. There are specially designed lanyards for these situations.

12 foot free fall lanyards have a maximum deployment distance of 60", so fall clearance needs to be taken into account. Fall clearance is the distance below your anchorage point that you'll fall without hitting the surface, or a structure below you. To calculate for a standard 6 foot free fall from an overhead anchor, take the length of the lanyard, 6 feet, plus the shock pack deployment, 48 inches, or 4 feet. Then, add your overall height, let's say 6 feet. So far we're at 16 feet of clearance. Finally, add a safety factor, 2 feet, to account for things like harness stretch and shifting. For this scenario, you'd need at least 18 feet of fall clearance before the nearest

obstruction to safely work. A foot level anchor requires more distance for the lanyard to begin stopping the fall, even though both lanyards are still 6 feet in length.

There are also some lanyards available which can be used in both 6 foot and 12 foot free fall scenarios. Check the badges and descriptions to find the right lanyard for you. If you have more questions, give one of our Gear Experts® a call.





GO TO WWW.GMESUPPLY.COM/LANYARDS
TO VIEW ENTIRE LANYARDS SELECTION ONLINE



6 FT
FREE FALL

12 FT
FREE FALL

CSA
COMPLIANT

QUICK SHIP

SKYLOTEC SKYSAFE PRO FLEX SHOCK ABSORBING LANYARD

6' length. The SkySafe Pro Flex Lanyard is the new and revolutionizing twin leg lanyard that has a weight range of 110 lbs to 308 lbs. This energy absorbing lanyard will always withstand a maximum impact of less than 6 kN at a maximum length of 5.74'. Will have a final impact resistance of 22 kN. Designed for foot level tie-off. ANSI and CSA compliant.

L-0558-1,8 Aluminum snaphook center, aluminum rebar hook ends (5.2 lbs) - \$297.99

L-0562-1,8 Steel snaphook center, steel rebar hook ends (6.4 lbs) - \$219.99

L-0533-1,8 Aluminum snaphook center, aluminum carabiner hook ends (4.2 lbs) - \$297.99

GEAR EXPERTS®

“ Make 100% tie off simple. The Skylotec Pro Flex is one of the only lanyards that keeps maximum arrest force under ANSI requirements whether the fall distance is 6' or 12'. This is possible because of their innovative two-stage shock pack, which allows for extra deceleration with the forces generated by longer falls. In the event of a fall, there are also web loops near the snaphooks that can be used for extraction. A lot of my clients find themselves at the top of monopoles with limited anchorage options, this lanyard is the solution. ”



MICHAEL OBUCHOWSKI

Southwest Regional Sales Manager



12 FT
FREE FALL

DBI SALA FORCE2 ELASTIC LANYARD

6.4 lbs. 6' length. 12' free fall and dual capacity rated. Tech-Lite aluminum D-rings on each leg end for rescue. Energy absorbing design limits fall arrest forces. Ideal when there is no overhead anchorage and your only option is to tie-off at your feet. Impact indicator. Abrasion resistant polyester webbing. Labels protected with i-Safe. ANSI compliant.

1246032 Aluminum snaphook center, aluminum rebar hook ends - \$364.99



NEW

12 FT
FREE FALL



12 FT
FREE FALL

CSA
COMPLIANT

QUICK SHIP

VIDEO



12 FT
FREE FALL



12 FT
FREE FALL

QUICK SHIP

VIDEO

DBI SALA FORCE2 ELASTIC 100% TIE-OFF SHOCK ABSORBING LANYARD

5.2 lbs. 6' length. Double-leg 100% tie-off lanyard. 311 - 420 lbs. Exclusive Hi-10 Vectran energy absorption system. Repel webbing. ANSI compliant.

1246415 Aluminum snaphook center, steel comfort grip ends - \$409.99

PETZL ABSORBICA-Y INTERNATIONAL

6' length. 110-286 lbs weight capacity. ANSI compliant.

L64YUM-150 Aluminum carabiner center, aluminum rebar hook ends (3.5 lbs) - \$299.95

L64YUT-150 Tie-back, steel carabiner center, steel rebar hook ends (5.25 lbs) - \$349.95

DBI SALA FORCE2 ELASTIC LANYARD

7.0 lbs. 6' length. 12' free fall and dual capacity rated. Stretches in reaction to your movements. Impact indicator. Resist polyurethane coated. ANSI compliant.

1244760 Steel snaphook center, steel rebar hook ends - \$299.99

WESTFALL PRO BLACK-MAX SHOCK ABSORBING LANYARD

6' length. Created with tower work in mind, the bungee style allows the lanyard to stretch and prevent trip hazards throughout the day, while the dual stage shock absorbers have been designed to arrest forces associated with a free fall of up to 12'. ANSI compliant.

62022 Steel snaphook center, aluminum rebar hook ends (5.5 lbs) - \$209.99

62021 Steel snaphook center, steel rebar hook ends (6.4 lbs) - \$174.99



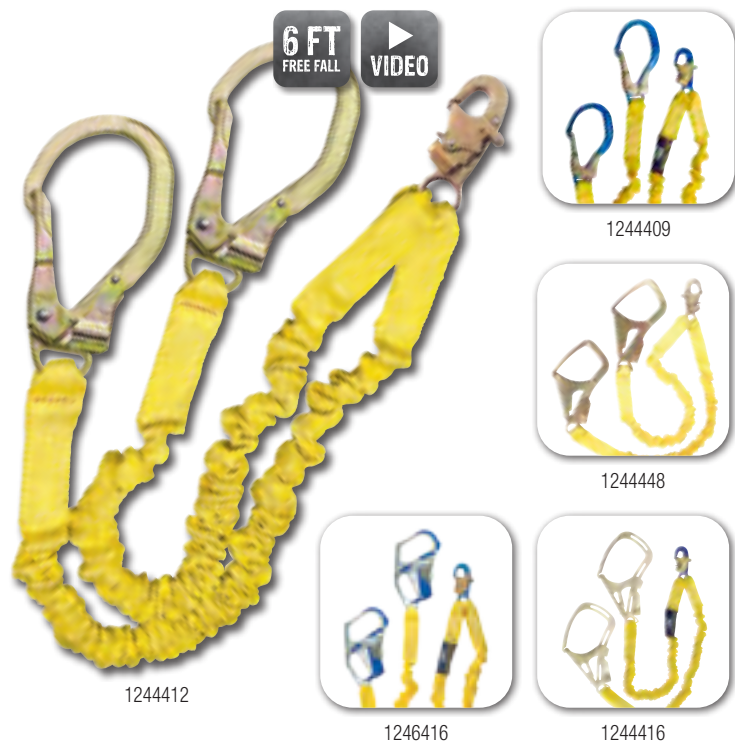

DBI SALA SHOCKWAVE SHOCK ABSORBING LANYARD

6' length. Stretches 4.5'-6' and reacts to your movements. Double-leg 100% tie-off lanyard. Abrasion resistant polyester tubular webbing. Energy absorbing design limits fall arrest forces. Built-in impact indicator. Protected labels, equipped with i-Safe. ANSI compliant.

- 1244412 Steel snaphook center, steel rebar hook ends (5.8 lbs) - \$257.99
- 1244409 Aluminum snaphook center, aluminum rebar hook ends (5.2 lbs) - \$239.99
- 1244448 Steel snaphook center, steel rebar hook ends (7.6 lbs) - \$353.99
- 1246416 Aluminum snaphook center, aluminum comfort grip ends (6.0 lbs) - \$352.99
- 1244416 Aluminum snaphook center, steel rebar hook ends (8.6 lbs) - \$403.99



PROTECTA PRO SHOCK ABSORBING LANYARD

6' length. Stretches 4.5'-6' and reacts to your movements. Abrasion resistant polyester tubular webbing. Energy absorbing design limits fall arrest forces. Built-in impact indicator. Made from high strength, durable and corrosion resistant materials to stand-up to demanding jobsites. ANSI compliant.

- 1340161 Steel snaphook center, steel rebar hook ends (6.1 lbs) - \$103.99
- 1340141 Steel snaphook center, steel snaphook ends (3.5 lbs) - \$77.99



GUARDIAN TIE-BACK SHOCK ABSORBING LANYARD

3.7 lbs. 6' length. Eliminates need for a separate anchorage connector. Adjustable tie-back point. 1" nylon webbing. ANSI compliant.

- 01291 Steel snaphook center, steel snaphook ends - \$89.99



ELK RIVER TIE-BACK SHOCK ABSORBING LANYARD

2.8 lbs. 6' length. Zorber energy-absorbing pack. 3,600 lb gate carabiners. ANSI compliant.

- 36936 Steel snaphook center, steel carabiner ends - \$138.44



FALLTECH VIEWPACK TIE-BACK SHOCK ABSORBING LANYARD

6.0 lbs. 6' length. Rugged 1" polyester webbing provides extreme UV resistance. Exclusive ViewPack design combines integral protection of labels and view-window for inspection of internal energy absorber. Tear-away absorber design limits fall forces to 900 lbs or less. ANSI compliant.

- 8260732D Steel snaphook center, steel rebar hook ends - \$114.99



PETZL ABSORBICA-Y TIE-BACK SHOCK ABSORBING LANYARD

5.1 lbs. 6' length. Features intermediate tie-back rings and a compact energy absorber. Designed for continuous protection on very large structures when passing intermediate anchor points. Arms are also elasticated to avoid hindering progression. ANSI compliant.

- L64YUT-150 Steel carabiner center, steel rebar hook ends - \$349.95





6 FT
FREE FALL

QUICK SHIP

WESTFALL PRO SHOCK ABSORBING LANYARD

6.3 lbs. 6' length. Stretches 4.5'-6'. Made with abrasion-resistant nylon webbing. Sewn on impact indicator. ANSI compliant.

62010 Steel snaphook center, steel rebar hook ends - \$114.99



NEW

6 FT
FREE FALL

QUICK SHIP

SAFEWAZE V-LINE DUAL-LEG LANYARD

3.6 lbs. 6' length. Tubular webbing. 3 double-action rebar hooks. 4 to 6 feet of maneuverability. Lightweight and durable. ANSI compliant.

019-2009 Steel rebar snap hooks - \$139.99



6 FT
FREE FALL

GUARDIAN STRETCH SHOCK ABSORBING LANYARD

6.8 lbs. 6' length. Stretches 4.5'-6'. Nylon and polyester webbing. ANSI compliant.

01298 Steel snaphook center, steel rebar hook ends - \$104.99



6 FT
FREE FALL

ELK RIVER FLEX ZORBER SHOCK ABSORBING LANYARD

5.9 lbs. 6' length. Nylon and polyester webbing. ANSI compliant.

36966 Steel snaphook center, steel rebar hook ends - \$179.99



6 FT
FREE FALL

QUICK SHIP

VIDEO



35428



35406



35488



35416



35716

ELK RIVER FLEX NOPAC SHOCK ABSORBING LANYARD

6' length. Stretches 4.5'-6'. 100% tie-off. Expandable design keeps lanyard legs out of your way. ANSI compliant.

35478 Steel snaphook center, steel rebar hook ends (5.8 lbs) - \$136.44

35428 Steel snaphook center, steel snaphook ends (4.0 lbs) - \$114.97

35406 Steel snaphook center, steel carabiner ends (6.3 lbs) - \$139.25

35488 Steel snaphook center, aluminum rebar hook ends (5.0 lbs) - \$179.39

35416 Steel snaphook center, aluminum carabiner ends (3.8 lbs) - \$205.23

35716 Aluminum carabiner center, aluminum carabiner ends (3.5 lbs) - \$239.47



6 FT
FREE FALL

VIDEO

QUICK SHIP



8240Y



8240Y3A

FALLTECH ELASTECH SHOCK ABSORBING LANYARD

6' length. Stretches 4.5'-6'. Expands and contracts to avoid tripping hazards. Internal high modulus elastic won't soften from frequent use. Heavy-duty tubular polyester outer jacket web resists abrasion and UV. ANSI compliant.

8240Y3 Steel snaphook center, steel rebar hook ends (6.4 lbs) - \$115.99

8240Y Steel snaphook center, steel snaphook ends (4.3 lbs) - \$77.99

8240Y3A Aluminum snaphook center, aluminum rebar hook ends (5.0 lbs) - \$159.99



6 FT
FREE FALL

1246193



1246409



1246245

DBI SALA EZ-STOP SHOCK ABSORBING LANYARD

6' length. Double-leg 100% tie-off lanyard. Stretches in reaction to your movements. Extremely compact and lightweight. Exclusive Hi-10 Vectran energy absorption system. Water-repellent repel webbing. Built-in reflective materials. Impact indicator. Protected labels, equipped with i-Safe. ANSI compliant.

1246193 Aluminum snaphook center, aluminum rebar hook ends (4.0 lbs) - \$322.99

1246409 Aluminum snaphook center, aluminum comfort grip hook ends (7.0 lbs) - \$384.99

1246245 Steel snaphook center, steel rebar hook ends (4.6 lbs) - \$281.99



6 FT
FREE FALL

QUICK SHIP

FALLTECH ELASTECH SHOCK ABSORBING LANYARD

5.9 lbs. 6' length. Durable tubular polyester outer jacket web resists abrasion and UV. Full-length internal energy absorber. Contrasting load-indicator stitch displays when a fall event has occurred. ANSI compliant.

8259Y3 Steel snaphook center, steel rebar hook ends - \$94.99



6 FT
FREE FALL

8357Y3

8357Y

FALLTECH VIEWPACK VINYL-COATED CABLE LANYARD

6' length. Rugged 1" polyester webbing provides extreme UV resistance. Tear-away absorber design limits fall forces to 900 lbs or less. ANSI compliant.

8357Y3 Steel snaphook center, steel rebar hook ends (6.7 lbs) - \$124.99

8357Y Steel snaphook center, steel snaphook ends (5.0 lbs) - \$90.99



6 FT
FREE FALL

FALLTECH FT BASIC SHOCK ABSORBING LANYARD

6.0 lbs. 6' length. Y-leg for 100% tie-off. 1" polyester webbing provides extreme UV resistance. 3,600 lb gate strength. ANSI compliant.

8256LTY3 Steel snaphook center, steel rebar hook ends - \$81.99



6 FT
FREE FALL

ELK RIVER FLEX-ZORBER SHOCK ABSORBING LANYARD

4.9 lbs. 6' length. 1-1/2" elasticized webbing stretches from 4.5' - 6'. 3,600 lb gate strength. ANSI compliant.

36897 Steel snaphook center, steel rebar hook ends - \$128.62



6 FT
FREE FALL

QUICK SHIP

ELK RIVER NOPAC SHOCK ABSORBING LANYARD

4.8 lbs. 6' length. Shock absorbing material is covered with a full-strength outer sheath. 100% tie-off. ANSI compliant.

35386 Steel snaphook center, steel rebar hook ends - \$117.82





FALLTECH VIEWPACK SHOCK ABSORBING LANYARD

Rugged 1" polyester webbing provides extreme UV resistance. Exclusive ViewPack design combines protection of labels with view-window for inspection of internal energy absorber. Integral label cover to protect warning and inspection labels. Tear-away absorber design limits fall forces to 900 lbs or less. ANSI compliant.

8253 Steel snaphook ends (3' length, 2.6 lbs) - \$42.99

8254 Steel snaphook ends (4' length, 2.7 lbs) - \$43.99

8256 Steel snaphook ends (6' length, 2.7 lbs) - \$44.99



FALLTECH SOFT PACK SHOCK ABSORBING LANYARD

1" polyester webbing provides extreme UV resistance. Tear-away absorber design limits fall forces to 900 lbs or less. Soft Pack cover protects tear-away energy absorbing web. ANSI compliant.

8256LT3FT Steel snaphook ends (3' length, 2.5 lbs) - \$36.99

8256LT Steel snaphook ends (6' length, 2.7 lbs) - \$38.99



11200

11201

GUARDIAN INTERNAL SHOCK ABSORBING LANYARD

6' length. Made with heavy duty outer polyester webbing. Polyester core sewn in. Lightweight. ANSI compliant.

11200 Steel snaphook ends (2.5 lbs) - \$39.99

11201 Steel snaphook end, steel rebar hook end (4.0 lbs) - \$79.99



DBI SALA EZ-STOP SHOCK ABSORBING LANYARD

Extremely compact and lightweight. Exclusive Hi-10 Vectran energy absorption system. Repel webbing. Built-in reflective materials. Impact indicator. Protected labels, equipped with i-Safe. ANSI compliant.

1246012 Steel snaphook ends (3' length, 2.0 lbs) - \$96.99

1246011 Steel snaphook ends (6' length, 2.2 lbs) - \$106.99

1246234 Steel snaphook ends (4'-6' Adjustable, 2.2 lbs) - \$117.99



GUARDIAN SHOCK ABSORBING LANYARD

Integrated shock absorbing component limits average arresting forces to 900 pounds or less. 1" nylon webbing. Clear shock absorbing pack for easy inspection. ANSI compliant.

01214 Steel snaphook ends (3' length, 2.5 lbs) - \$25.99

01220 Steel snaphook ends (6' length, 2.75 lbs) - \$38.99



82403A

8240A

FALLTECH ELASTECH SHOCK ABSORBING LANYARD

6' length. Stretches 4.5'-6'. Heavy duty tubular polyester outer jacket web resists abrasion and UV. Internal high modulus elastic won't soften from frequent use. Full-length internal energy absorber limits fall forces to 900 lbs or less. ANSI compliant.

82403A Aluminum snaphook end, aluminum rebar hook end (3.1 lbs) - \$90.99

82403 Steel snaphook end, steel rebar hook end (3.7 lbs) - \$69.99

8240A Aluminum snaphook ends (2.3 lbs) - \$79.99





GO TO WWW.GMESUPPLY.COM/POSITIONING
TO VIEW ALL POSITIONING EQUIPMENT



PETZL GRILLON MGO ADJUSTABLE POSITIONING LANYARD

This lanyard is used to make work positioning systems, to complement a fall-arrest system. Its length can be very easily and precisely adjusted as necessary for comfortable positioning at the work station. Connector with very large gate opening is ideal for connection to metal structures or to large-diameter cables and bars. ANSI Z359.3 and CSA Z259.11 compliant.

- L052DA00 2 m (6.56', 2.7 lbs) - \$249.95
- L052DA01 3 m (9.84', 2.9 lbs) - \$254.95



COMPLETE YOUR TREE CARE KIT

POSITIONING	33
HARDWARE	49
ROPE	54
ASCENDERS	62
DESCENDERS	64
HELMETS	120
GLOVES	134

SEE TREE CARE SUPPLIES
ON PAGE 100



PETZL GRILLON PLUS ADJUSTABLE POSITIONING LANYARD

Adjustable work positioning lanyard with excellent abrasion resistance. Used to make work positioning systems, to complement a fall-arrest system. Its length can be very easily and precisely adjusted as necessary for comfortable positioning at the work station. The aramid fiber rope provides excellent abrasion resistance. Depending on the configuration, it can be used in single or double mode. ANSI Z359.3 and CSA Z259.11 compliant.

- L052EA00 2 m (6.56', 1.0 lb) - \$234.95
- L052EA01 3 m (9.84', 1.1 lbs) - \$249.95

PETZL GRILLON ADJUSTABLE POSITIONING LANYARD

Lanyard with fine adjustment system for precise work positioning. Can be used in double mode to distribute weight on the belt or single mode to distribute weight between the waist belt and leg loops. Removable protective sheath protects the rope from abrasive surfaces and enhances rope glide. Certification(s): ANSI Z359.3, CSA Z259.11, CE EN 358, CE EN 12841 type C, EAC.

WITHOUT HOOK CONNECTOR

- L052AA00 2 m (6.56', 1.1 lbs) - \$199.95
- L052AA01 3 m (9.84', 1.2 lbs) - \$204.95
- L052AA02 4 m (13.12', 1.4 lbs) - \$209.95
- L052AA03 5 m (16.40', 1.6 lbs) - \$214.95
- L052AA04 10 m (32.81', 2.4 lbs) - \$239.95
- L052AA05 15 m (49.21', 3.3 lbs) - \$264.95
- L052AA06 20 m (65.62', 4.1 lbs) - \$289.95

WITH HOOK CONNECTOR

- L052CA00 2 m (6.56', 1.7 lbs) - \$229.95
- L052CA01 3 m (9.84', 1.9 lbs) - \$234.95
- L052CA02 4 m (13.12', 2.1 lbs) - \$239.95
- L052CA03 5 m (16.40', 2.2 lbs) - \$244.95



L052CA

GEAR EXPERTS®

“ The Grillon is simple, intuitive, and versatile. The handle mechanism allows the user to easily adjust themselves into working position while feeling completely in control. For single and double mode usage most climbers will opt for a shorter rope length, usually between 2-4 meters. If you're wondering what on earth you'd need 20 meters of rope for, the Grillon can operate as a temporary horizontal lifeline! ”



JIM ZEPP
Southern Regional Sales Manager

PETZL GRILLON REPLACEMENT LANYARD

Replacement lanyard for the Petzl Grillon that allows a horizontal lifeline to be installed quickly when there is a large work surface.

- L52F 002 2 m (6.56', 0.6 lbs) - \$64.95
- L52F 003 3 m (9.84', 0.8 lbs) - \$69.95
- L52F 004 4 m (13.12', 1.0 lbs) - \$74.95
- L52F 005 5 m (16.40', 1.2 lbs) - \$79.95
- L52F 010 10 m (32.81', 1.9 lbs) - \$99.95
- L52F 015 15 m (49.21', 2.9 lbs) - \$129.95
- L52F 020 20 m (65.62', 3.7 lbs) - \$149.95

HOOK REPLACEMENT LANYARD

- L052HA00 2 m (6.56', 1.25 lbs) - \$89.95
- L052HA01 3 m (9.84', 1.45 lbs) - \$94.95
- L052HA02 4 m (13.12', 1.75 lbs) - \$99.95
- L052HA03 5 m (16.40', 1.95 lbs) - \$104.95



PETZL MGO OPEN CONNECTOR

1.1 lbs. This auto-locking, directional connector features a large gate opening for connecting to metal structures or large diameter cables and bars. 23 kN major axis strength, and 63 mm gate opening.

- M080AA00 MGO Open 110 - \$129.95
- MG00 60 MGO Open 60 - \$79.95
- M043AA00 Eashook open, gray & yellow - \$39.95
- M043AA01 Eashook open, black - \$41.95



M080AA00

MG00 60

M043AA00



ELK RIVER POSITIONING WEB LANYARD

3,600 lbs gate, 1" wide webbing. Used for work positioning. ANSI compliant.

- 29022 Steel snaphook ends (2' length, 1.5 lbs) - \$45.49
- 29023 Steel snaphook ends (3' length, 1.6 lbs) - \$45.16
- 29024 Steel snaphook ends (4' length, 1.7 lbs) - \$47.71
- 29026 Steel snaphook ends (6' length, 1.8 lbs) - \$49.59
- 29506 Steel snaphook ends (adjustable 3'-6' length, 2.3 lbs) - \$57.01



ELK RIVER CENTURION ROPE LANYARD

Nylon rope. 3,600 lbs gate. ANSI compliant.

- 28013 Steel snaphook ends (3' length, 2.3 lbs) - \$40.98
- 28014 Steel snaphook ends (4' length, 2.4 lbs) - \$41.95
- 28016 Steel snaphook ends (6' length, 2.5 lbs) - \$43.79



FALLTECH WEB RESTRAINT LANYARD

1" wide polyester webbing provides extreme UV resistance. ANSI compliant.

- 82093 Steel snaphook end, steel rebar hook end (4'-6' adjustable length, 3 lbs) - \$44.99
- 8203 Steel snaphook ends (3' length, 1.9 lbs) - \$33.99
- 8204 Steel snaphook ends (4' length, 1.9 lbs) - \$34.99
- 8209 Steel snaphook ends (9' length, 2.2 lbs) - \$47.99



GUARDIAN ADJUSTABLE POSITIONING WEB LANYARD

2.0 lbs. Adjusts from 4'-6'. Ideal for positioning and restraint situations. Comes with additional carabiner.

- 01280 Steel snaphook ends - \$37.99



ELK RIVER ADJUSTABLE 1/2" ROPE POSITIONING LANYARD

2.4 lbs. 1/2" x 6'. Polyester and nylon rope construction. Captive eye carabiner with 3.6 m gate. Aluminum sliding adjuster. 1/2" gate opening carabiner. Man rated to 310 lbs for positioning only. Maximum load: 3,600 lbs. Separate fall arrest required. Meets or exceeds OSHA 1926.

- 34496 Steel carabiner end - \$176.47



SKYLOTEC LORY POSITIONING LANYARD

Lightweight adjustable positioning lanyard with descender. 2 m rope, (2) sewn eyes, and a protective sheath protects the rope from abrasive surfaces and allows smooth rope glide.

- L-0691-2 No end attachments (1.5 lbs) - \$199.99
- L-0693-1.5 Steel snaphook end (3.0 lbs) - \$259.99
- L-0695-1.5 Aluminum rebar hook end (2.5 lbs) - \$269.99



DBI SALA ADJUSTABLE ROPE POSITIONING LANYARD

2.4 lbs. 8' length. Complements a variety of fall protection systems as a versatile positioning device, allowing the user to wrap around numerous anchors. Lightweight design weighs just 2.2 lbs. Abrasion resistant sleeve helps prolong product life. Blue wear indicating core signals the user when the product needs to be taken out of service.

- 1234070 Steel snaphook end - \$327.99



Trigger X quick tip, call our Gear Experts® for more information.

The Trigger X was designed to be the premier option for positioning lanyards. To accomplish that, 3M added a feature unique to this device. The 1234084 and 1234086 models are capable of tie-back which can reduce the need for multiple devices. The protective sheath protects the rope from abrasive surfaces when used as a tie-back device.



NEW
QUICK SHIP

DBI SALA TRIGGER X ADJUSTABLE ROPE POSITIONING LANYARD

ANSI & ASTM rated for single mode use. Available in 6', 8' and 10' options. 1234084 & 1234086 tie-back capable.

1234084 Steel rebar end (8' length, 2.9 lbs) - \$301.99

1234085 Aluminum rebar end (8' length, 2.9 lbs) - \$292.99

1234086 Aluminum snaphook end (8' length, 2.2 lbs) - \$272.99



QUICK SHIP

WESTFALL PRO TOWER POSITIONING KIT

Kit includes the following components: 2-1/4" swivel form hook, 3/4" spreader bar, 3/4" fall rated steel carabiner, ANSI compliant.

13400 Kit (3.7 lbs) - \$89.99

7475 Spreader bar only (1.6 lbs) - \$38.99

SEE HARDWARE ON PAGES 49-53

ELK RIVER QUICK-ADJUSTABLE ROPE POSITIONING LANYARD

2.8 lbs. 5/8" x 6'. Polyester kernmantle rope. ErgoGrip adjuster with carabiner.

34416 Steel carabiner end - \$181.95



QUICK SHIP

ELK RIVER QUICK-ADJUSTABLE ROPE POSITIONING LANYARD

3.2 lbs. 5/8" x 6'. Made from 3-strand nylon rope. Rope grab with carabiner. Man rated to 310 lbs.

34406 Steel snaphook end - \$72.03



QUICK SHIP
CSA COMPLIANT

PROTECTA ADJUSTABLE WEB POSITIONING LANYARD

1.9 lbs. 6' length. Made from abrasion resistant polyester webbing. Built-in wear indicator. Lightweight and adjustable. 3,600 lbs gate strength. ANSI compliant.

1385301 Steel snaphook ends - \$41.99



ELK RIVER REBAR WEB ASSEMBLY

3/4" Centurion snaphook ends and 2-1/2" Centurion rebar hook center. Tie back compatible. ANSI compliant.

29740 14" (3.6 lbs) - \$69.45

29741 18" (3.6 lbs) - \$71.53

29743 24" (3.7 lbs) - \$74.31

29761 with Swivel - \$83.41



WESTFALL PRO SEPARATOR SPREADER BAR SNAPHOOK

1.6 lbs. 9-3/4" x 2-1/4", 3/4" throat opening, 22.2 kN, double locking snaphooks, ANSI compliant.

7475 - \$38.99



QUICK SHIP

SRL, SRD, PFL 101

WHAT IS A SELF-RETRACTING LIFELINE?

A Self-Retracting Lifeline, or SRL, is a device that contains a spring loaded retracting web or cable lanyard wound around an internal drum. It automatically locks and arrests the fall of a worker.

CLASS A vs CLASS B

ANSI Z359.14-2012 classifies Self-Retracting Lifelines and Personal Fall Limiters into two classes. The main differentiators between the two are stopping distance and arresting forces.

Class A

- Maximum arresting distance not to exceed 24".
- Average arresting force not to exceed 1,350 pounds or 6 kN or have a maximum peak of 1,800 pounds or 8 kN.
- After environmental conditioning (hot, cold, wet), average arresting force not to exceed 1,575 pounds or 7 kN or a maximum peak of 1,800 pounds or 8 kN.

Class B

- Maximum arresting distance not to exceed 54".
- Average arresting force not to exceed 900 pounds or 4 kN or have a maximum peak of 1,800 pounds or 8 kN.
- After environmental conditioning (hot, cold, wet), average arresting force not to exceed 1,125 pounds or 5 kN or a maximum peak of 1,800 pounds or 8 kN.

CLASS

A

CLASS

B

LOOK FOR THESE BADGES THROUGHOUT THE CATALOG.

SWING FALL

SRLs are great because they allow you to work much farther away from an anchorage point, sometimes over 100 ft. The downside to this is swing falls become much more of a danger.

A swing fall occurs when an anchorage point is not directly overhead of a worker. The device will stop them in the required distance, but the worker may still swing a great distance. This potentially puts other obstacles, walls, or objects in the path for the worker to collide with.

To avoid swing falls, always stay in the safe zone, which is within 30 degrees of your anchor point. Swing falls can be avoided by using mobile anchorage points which will travel with the worker.

BODY WORN vs MOUNTED

Larger SRLs are mounted above the worker, and the lanyard runs down to connect to the user's dorsal D-ring on their harness. These come in lengths ranging from 8 ft to over 100 ft. The other option is body worn. These are compact devices which connect directly to the users harness and are much shorter, generally 6 or 8 ft. To tie-off the user connects the tether to an anchorage point. These can also be had in twin-leg configuration for 100% tie-off.

LEADING EDGE + FOOT LEVEL

Most SRLs are designed only to be mounted above the user. For cases where this is not possible, specially designed Foot Level or Leading Edge SRLs are required. ANSI classifies these as SRL-LE devices. These incorporate factors to absorb the extra energy associated with foot-level tie off, as

well as more robust cables to resist breaking when run against a leading edge.

LE

LOOK FOR THIS BADGE THROUGHOUT THE CATALOG.

REPLACEMENT & RECERTIFICATION

Recertification can be done on some SRLs by the manufacturer to prolong the life of the unit. This can be done after the device is involved in a fall, or after the unit has been in the field for a specific period of time. Check with the manufacturer for specifications on recertification.

Other devices cannot be recertified and must be destroyed and replaced if they are involved in a fall or after a time period specified by the manufacturer.

OTHER VARIATIONS

Other potential options for SRL variations include:

- Sealed design for harsh work environments with grease, dust, and moisture.
- Rescue Devices, referred to as SRL-R by ANSI, for auto retrieval. These are common on confined space systems.
- Tie-Back for when connectors cannot secure to anchorage points.
- Arc Flash rated for working in electrical environments.

More questions?

Give our Gear Experts® a call.

FREE
DOWNLOAD

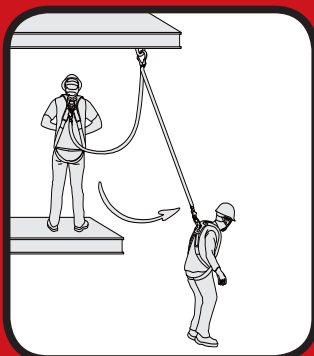

SWING FALL



BODY WORN

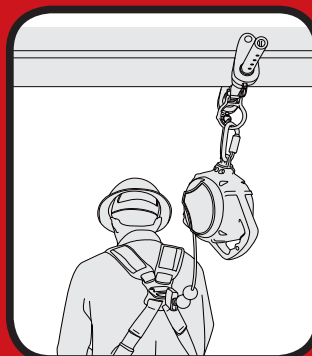

MOUNTED



LEADING EDGE

FALL CLEARANCES 101

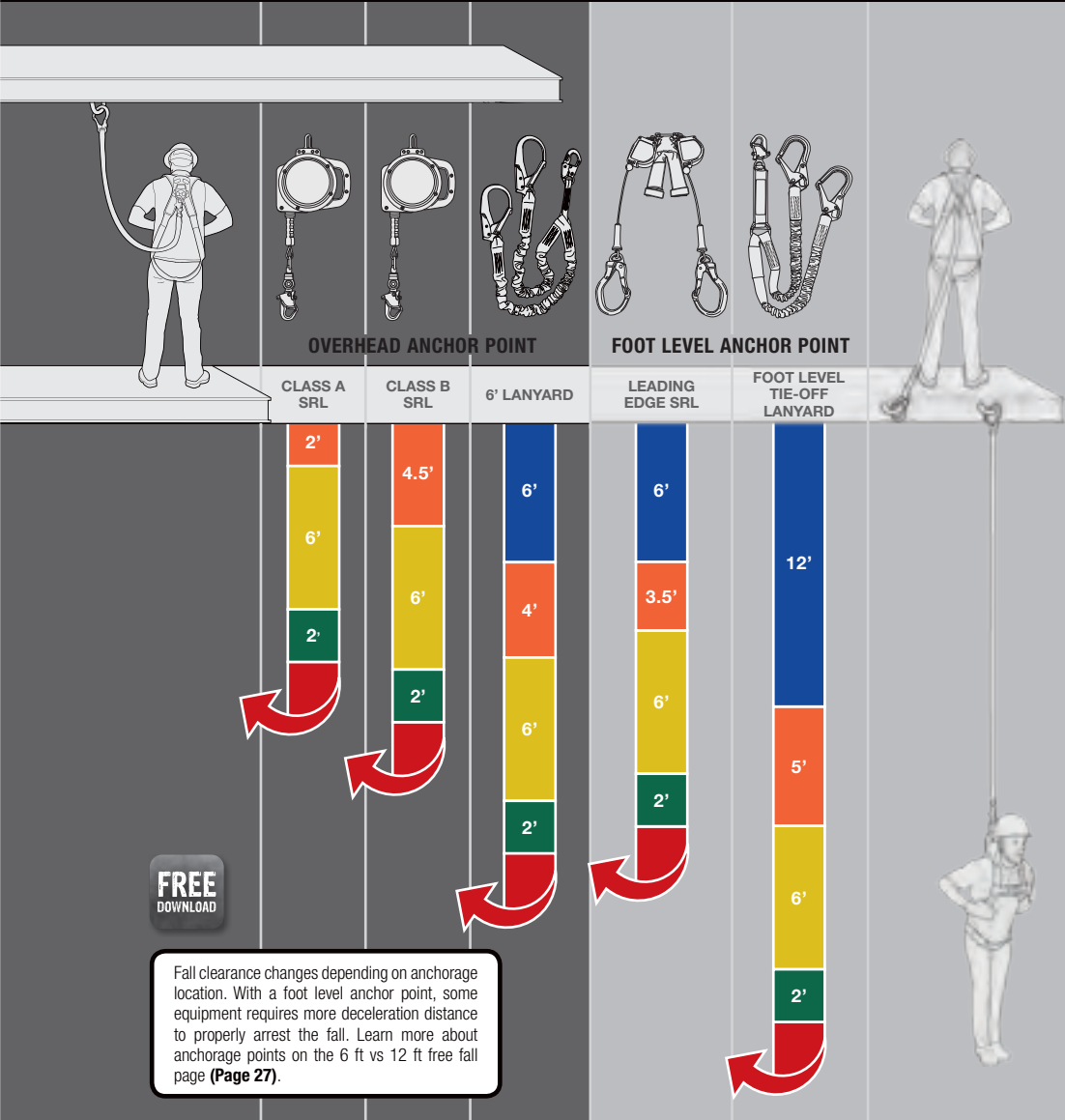

FREE FALL DISTANCE

Free fall is the distance covered before the fall arrest device engages or catches you. This distance varies for a couple reasons. Different devices take longer than others to engage. Your anchorage point also plays a part. See the 6 ft vs 12 ft free fall page for more information on this topic (Page 27).

DECELERATION DISTANCE

This is the distance required to fully arrest the fall. Once the device has caught, its energy absorber will require time and distance to stop you. Again, depending on the type of device, this distance can be just a few inches to multiple feet.

HEIGHT OF DORSAL D-RING

This is the typical average height of the dorsal D-Ring on a user's full body harness measured up from the walking working surface.

HARNES & D-RING SHIFT + SAFETY FACTOR

This is the combined amount of harness webbing elongation and dorsal D-Ring up-shift during the entire fall event. It's recommended to consider this additional distance as a safety factor.

SWING FALL

Swing fall occurs when your anchorage is not directly above you. This hazard is typically most associated with SRLs since you're able to work much farther from your anchorage point.

The device will stop a fall in the required distance, but the worker may still swing a great distance, similar to a pendulum. This potentially puts obstacles, walls, or even the ground in the path of the worker.

It is recommended to always work within a 30 degree safe zone from your anchor. If you must work farther away than this 30 degree safe zone, you must either transition to a different anchor, or consider using a mobile anchor, such as a beam slider (Page 47).

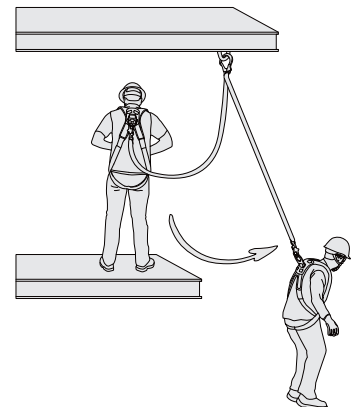

REGULATIONS

OSHA 1910.140

1910.140(c)(5)

Self-retracting lifelines and lanyards that automatically limit free fall distance to 2 ft (0.61 m) or less.

1910.140(d)(1)(ii)

Personal fall arrest systems must bring the employee to a complete stop and limit the maximum deceleration distance the employee travels to 3.5 ft (1.1 m).

OSHA 1926.502

1926.502(d)(16)(iv)

Personal fall arrest systems, when stopping a fall, shall bring an employee to a complete stop and limit maximum deceleration distance an employee travels to 3.5 ft (1.07 m).

STANDARDS

ANSI Z359.13 - 2013

PERSONAL ENERGY ABSORBERS & ENERGY ABSORBING EQUIPMENT

3.1.8.1

6 ft free fall personal energy absorbers shall have a maximum deployment distance of 48 inches.

3.1.8.2

12 ft free fall personal energy absorbers shall have a maximum deployment distance of 60 inches.

Always refer to manufacturer's specifications. Proper fall protection training is required before performing any at-height work.

MILLER SCORPION

The lightweight, compact design of the Scorpion PFL provides workers an affordable alternative to shock absorbing lanyards. They offer greater mobility, safety, and versatility when compared to shock absorbing lanyards. Requires less fall clearance and prevents tripping hazards. Visual load indicator indicates when the unit must be removed from service. Quick-activating, high-strength stainless steel braking system. Attach it directly to the harness D-ring for use as a personal fall limiter, or use it as a traditional retractable lifeline. Variety of integral anchorage connectors available. Thermoplastic cover, aluminum extrusion, and polyester webbing. ANSI compliant.

CLASS
A

PFL-2-Z7/9FT PFL-4-Z7/9FT PFL-6-Z7/9FT PFL-7-Z7/9FT PFL-15-Z7/9FT

PART	LEGS	END CONNECTOR	UNIT CONNECTOR	WEIGHT	PRICE
PFL-2-Z7/9FT	Single	Steel snaphook	Steel carabiner	3.8 lbs	\$189.99
PFL-4-Z7/9FT	Single	Steel snaphook	Swiveling steel carabiner	4.0 lbs	\$209.99
PFL-6-Z7/9FT	Single	Steel snaphook	Swiveling steel rebar hook	4.7 lbs	\$239.99
PFL-7-Z7/9FT	Single	Steel snaphook	Swiveling steel snaphook	4.1 lbs	\$234.99
PFL-9-Z7/9FT	Single	Steel rebar hook	Swiveling steel carabiner	4.4 lbs	\$279.99
PFL-11-Z7/9FT	Single	Steel rebar hook	Swiveling steel snaphook	4.4 lbs	\$242.99
PFL-15-Z7/9FT	Single	Steel swivel snaphook	No unit connector	3.3 lbs	\$189.99



GUARDIAN DIABLO

The Diablo Self-Retracting Lifelines offers superior protection and its design makes it supremely lightweight and durable. It is available with steel or aluminum snaphooks or rebar hooks and can be purchased on its own or in a kit of two, which allows it to transform into a double unit. When the job requires a highly mobile and sturdy SRL, the Diablo is the perfect choice, available in 6' lengths. The Diablo Single SRL includes a carabiner and the Diablo Double SRL Kit includes a carabiner and connector bracket. When used in combination with proper PPE (i.e. harness and anchor), the Diablo SRL has a capacity range up to 420 lbs, ANSI compliant.

CLASS
A

VIDEO

11016 11080 11081 11082 11083 11084

PART	LEGS	END CONNECTOR	UNIT CONNECTOR	WEIGHT	PRICE
11016	Single	Steel snaphook	Swiveling steel carabiner	2.5 lbs	\$144.99
11080	Single	Steel snaphook	Swiveling steel carabiner	2.25 lbs	\$149.99
11081	Single	Aluminum carabiner	Swiveling steel carabiner	2 lbs	\$169.99
11082	Single	Aluminum rebar hook	Swiveling steel carabiner	2.75 lbs	\$194.99
11083	Single	Steel rebar hook	Swiveling steel carabiner	3.25 lbs	\$199.99
11084	Twin	Steel snaphooks	Carabiner & bracket	5.5 lbs	\$319.99
11085	Twin	Aluminum carabiner	Carabiner & bracket	5.75 lbs	\$334.99
11086	Twin	Aluminum rebar hooks	Carabiner & bracket	6.5 lbs	\$379.99
11087	Twin	Twin steel rebar hooks	Carabiner & bracket	7.5 lbs	\$399.99



FALLTECH DURATECH MINI

Compact and impact resistant nylon housing. Integral shock absorber provides visual fall event indication after deceleration. Abrasion resistant Dyneema lifeline webbing provides longer service life. Integral swiveling eye reduces twisting. Internal locking pawls provide quick and positive stopping action. ANSI compliant.

CLASS
B

72706SA1 72706SG6 72706TB1 72706TB3 72706TB5

PART	LEGS	END CONNECTOR	UNIT CONNECTOR	WEIGHT	PRICE
72706SA1	Single	Steel snap hook	Swiveling eye	2.2 lbs	\$134.99
72706SB1	Single	Steel snap hook	Swivel with steel carabiner	2.8 lbs	\$152.99
72706SB4	Single	Aluminum snap hook	Swivel with steel carabiner	2.6 lbs	\$168.99
72706SG6	Single	Aluminum carabiner	Swivel with steel carabiner	1.9 lbs	\$180.99
72706TB1	Twin	Steel snap hooks	Carabiner & bracket	4.9 lbs	\$349.99
72706TH3	Twin	Steel rebar hooks	Carabiner & bracket	7.2 lbs	\$359.99
72706TH5	Twin	Aluminum rebar hooks	Carabiner & bracket	6.1 lbs	\$387.99
72706TB6	Twin	Aluminum carabiners	Carabiner & bracket	3.8 lbs	\$330.99
72706TB3	Twin	Steel rebar hooks	Carabiner & bracket	6.6 lbs	\$249.99
72706TB5	Twin	Aluminum rebar hooks	Carabiner & bracket	6.1 lbs	\$360.99





PROTECTA
Fall Protection



GO TO WWW.GMESUPPLY.COM/SRLS
TO VIEW ENTIRE SRLS SELECTION ONLINE



3100403



3100404



3100405



3100412



3100413



3100414



CLASS
B



PROTECTA REBEL

Rebel personal SRL's are ergonomically designed for ease-of-use and are ideal for direct connection to most harnesses. The compact and lightweight design is barely noticeable on your back and stays out of the worker's way. Tension is always kept on the lifeline, which reduces dragging, snagging and trip falls. These Rebel SRL's lock quickly, stopping falls within inches, providing more protection at low heights.

PART	LENGTH	LEGS	END CONNECTOR	UNIT CONNECTOR	WEIGHT	PRICE
3100403	6'	Single	Steel snaphooks	Swiveling steel carabiner	2.9 lbs	\$122.99
3100404	6'	Single	Steel snaphooks	Swiveling steel carabiner	3.1 lbs	\$131.99
3100405	6'	Single	Steel rebar hook	Swiveling steel carabiner	3.6 lbs	\$152.99
3100412	6'	Twin	Steel snaphooks	Built-in	5.3 lbs	\$250.99
3100413	6'	Twin	Steel snaphooks	Built-in	5.8 lbs	\$254.99
3100414	6'	Twin	Steel rebar hooks	Built-in	6.8 lbs	\$281.99

MFLC-3-Z7/6FT



MFLC-3-Z7/9FT



MFLC-4-Z7/6FT



MFLC-11-Z7/6FT



MFLC-12-Z7/6FT



MFLC-12-Z7/9FT



CLASS
A



MILLER TWIN TURBO G2

The Miller Twin Turbo G2 is a compact, lightweight device, uniquely engineered to allow two compatible personal fall limiters (or self-retracting lifelines) to be connected with the back of a user's harness for a 100% tie-off fall protection. Its corrosion-resistant aluminum connector teamed with high-impact nylon result in a longer product life. While this device is rated as Class A for workers weighing up to 310 lbs, it can be used as a Class B device for workers up to 400 lbs.

PART	LENGTH	LEGS	END CONNECTOR	UNIT CONNECTOR	WEIGHT	PRICE
MFLC-3-Z7/6FT	6'	Twin	Steel snaphooks	Built-in	4.6 lbs	\$345.99
MFLC-3-Z7/9FT	9'	Twin	Steel snaphooks	Built-in	5.2 lbs	\$359.99
MFLC-4-Z7/6FT	6'	Twin	Steel rebar hooks	Built-in	6.6 lbs	\$429.99
MFLC-11-Z7/6FT	6'	Twin	Aluminum snaphooks	Built-in	4.2 lbs	\$359.99
MFLC-12-Z7/6FT	6'	Twin	Aluminum rebar hooks	Built-in	5.8 lbs	\$419.99
MFLC-12-Z7/9FT	9'	Twin	Aluminum rebar hooks	Built-in	6.6 lbs	\$499.99





CLASS
B

PROTECTA REBEL RETRIEVAL CABLE SRL

3/16" stainless steel cable lifeline, aluminum housing, 3-way emergency retrieval system, speed sensing all metal brake system, internal energy absorption system, swiveling anchorage point and self-locking snap hook, man-rated 310 lbs, ANSI compliant.

3591001 50' - \$1,987.99



CLASS
B

FRENCH CREEK THREE WAY UNIT

Galvanized steel cable, capable of raising or lower for rescue or retrieval, friction brake prevents crank hand from free-wheeling, aluminum housing, ANSI compliant.

R50G 50' - \$1,375.00



CLASS
B

ELK RIVER RESCUE & RECOVERY CABLE SRL

3/16" steel wire rope, composite housing, fall indicator, man-rated 310 lbs, ANSI compliant.

21970 50' - \$1,741.34



CLASS
B

MILLER MIGHTEVAC CABLE SRL WITH EMERGENCY HOIST

Lightweight and corrosion-resistant stainless steel/ aluminum components, promotes quick and easy rescue with a 4:1 mechanical advantage, 310 lbs weight capacity, for emergency evacuation only, ANSI compliant.

MR50GB-Z7 50' - \$2,696.99

MR100GB-Z7 100' - \$3,254.99

MR130GB-Z7 130' - \$3,567.99

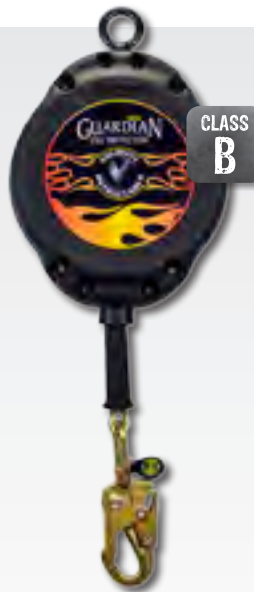

CLASS
B

GUARDIAN VELOCITY CABLE SRL

Glass-filled nylon housing, swivel top and swivel snaphooks, lightweight and durable, average arrest force: 900 lbs, maximum arrest force: 1,800 lbs, maximum deceleration distance: 54", ANSI compliant.

42003 50' - \$599.99

42004 80' - \$997.99

42005 100' - \$1099.99



CLASS
B

SAFEMATE EXTREME RETRACTABLE CABLE SRL

3/16" aircraft cable, heavy duty nylon housing with reinforced carrying handle and swivel top, 3,600 lbs gate-rated snaphook, unique breaking system that eases shock in the event of a fall, man-rated 310 lbs, ANSI compliant.

FS-EX1080G 80' - \$950.00

FS-EX10-100-G 100' - \$1,510.00



CLASS
B

SKYLOTEC RAPTOR

Rated to 140 KG or 308 pounds. Dual fall indicators. Modular design for easy servicing. Available in Web Lanyard and Galvanized Wire Rope. ANSI compliant.

HSG-US-040-6 Web 20' - \$269.95

HSG-US-040-8 Web 26' - \$299.95

HSG-US-042-6 Wire 20' - \$269.95

HSG-US-042-10 Wire 30' - \$324.95

HSG-US-042-20 Wire 65' - \$499.95



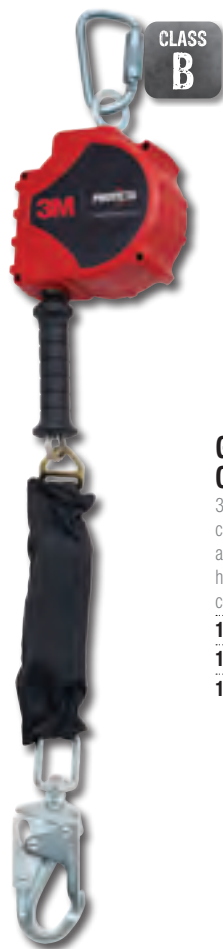

CLASS
B

PROTECTA REBEL CABLE SRL

Rugged aluminum and steel construction, galvanized steel cable, swiveling anchorage loop, Kevlar/Nomex covered external shock pack, swiveling snaphook, ANSI compliant.

- 3590016 11' - \$256.99
- 3590019 15' - \$295.99



CLASS
B

GUARDIAN HALO CABLE SRL

3/16" galvanized cable with carabiner, swivel top, snaphook, and tagline; durable aluminum housing, non-corrosive components, ANSI compliant.

- 10910 20' - \$444.99
- 10912 25' - \$449.99
- 10915 30' - \$459.99

GEAR EXPERTS®

“ I know there are a lot of different options which can seem overwhelming. We have some good resources to help ensure that you select the right SRL, SRD, PFL 101 cheat sheet on **page 36** to make sure you don't need a more specialized solution. Also, if you're ever looking for some extra help, or simply can't find what you're looking for, give me or any one of our Gear Experts® a call. ”



CODY SELLERS
Northwest Regional Sales Manager



CLASS
B
VIDEO

DBI SALA RSQ CABLE SRL WITH RESCUE

Dual-mode operation, prior to connection choose between fall arrest (requiring assisted rescue), or self rescue; fall arrest mode stops falls within inches - assisted rescue procedures can then be implemented either at the mode selector or remotely with an assisted rescue tool; self rescue mode automatically lowers the user to the next level, galvanized cable lifeline extends and retracts automatically enabling safe mobility, ANSI compliant.

- 3504550 50' - \$1,389.99
- 3500101 Assisted rescue tool - \$252.99



CLASS
B

DBI SALA SEALED BLOK CABLE SRL

Galvanized steel cable, self-locking swivel snaphook with impact indicator, pivoting anchorage loop, aluminum housing, anti-ratcheting, ANSI compliant.

- 3400900 50' - \$1,507.99
- 3400860 85' - \$2,254.99
- 3400965 130' - \$3,104.99



CLASS
B

DBI SALA SEALED BLOK CABLE SRL RETRIEVAL / BRACKET

3-way emergency retrieval system, fast-line lifeline system, galvanized steel cable, swivel snaphook with impact indicator, pivoting anchorage loop, aluminum housing, anti-ratcheting, ANSI compliant.

- 3400853 30' - \$3,111.99
- 3400923 50' - \$3,673.99
- 3400871 85' - \$4,541.99
- 3400976 130' - \$5,605.99



CLASS
B

DBI SALA ULTRA-LOK CABLE SRL

3/16" galvanized steel wire rope, self-locking swivel snaphook with impact indicator, anti-ratcheting twin disc brake system, ANSI compliant.

- 3504430 30' - \$1,081.99
- 3504450 50' - \$1,309.99
- 3504485 85' - \$1,555.99





PROTECTA REBEL WEB SRL

Housing with carabiner, rugged nylon thermoplastic housing, unique super-strength thin webbing, ANSI compliant.

3100425 11' Steel snaphook end - \$128.99

3100431 20' Steel snaphook end - \$229.99

3100427 11' Steel rebar hook end - \$176.99

3100433 20' Steel rebar hook end - \$284.99

CLASS B



GUARDIAN HALO WEB SRL

Swiveling carabiner top, ergonomic frame makes handling more comfortable, stainless steel and non-corrosive components, quick-action braking system, ANSI compliant.

10900 11' Steel snaphook end - \$128.99

10901 11' Steel rebar hook - \$182.99

CLASS B



GUARDIAN VELOCITY WEB SRL

Swiveling top with carabiner and steel snaphook end, polyester webbing, ANSI compliant.

42006 20' - \$318.99

42008 40' - \$399.99

CLASS B



ELK RIVER JAGUAR WEB SRL

3/4" Dyneema webbing, carabiner and tagline included, swivel snaphook 3.6 m gate with fall indicator, ANSI compliant.

22426 26' - \$416.68

CLASS B



FALLTECH DYNEEMA CONTRACTOR WEB SRL

High strength, superior cut, and abrasion resistant Dyneema webbing, load-indicating swivel carabiner and connecting carabiner, ANSI compliant.

7276WR 20' - \$264.99

CLASS B

QUICK SHIP

ITEM	DESCRIPTION	LENGTH	CLASS	HOUSING	WEIGHT	CAPACITY	RECERTIFIABLE	LE	QUICKSHIP*	PRICE
MRG3-OZ	French Creek Rogue Web SRL	9'	A	Thermoplastic	3.1 lbs	400 lbs				\$159.99
PFL-2-27/9FT	Miller Scorpion PFL Web SRL	9'	A	Thermoplastic & aluminum	3.8 lbs	400 lbs				\$189.99
PFL-4-27/9FT	Miller Scorpion PFL Web SRL	9'	A	Thermoplastic & aluminum	4.0 lbs	400 lbs				\$209.99
10900	Guardian Halo Web SRL	11'	B	Aluminum	3.4 lbs	310 lbs			✓	\$128.99
3100425	Protecta Rebel Web SRL	11'	B	Thermoplastic	3.6 lbs	310 lbs			✓	\$128.99
3100427	Protecta Rebel Web SRL	11'	B	Thermoplastic	4.3 lbs	310 lbs				\$176.99
10901	Guardian Halo Web SRL	11'	B	Aluminum	4.2 lbs	310 lbs				\$205.99
RG3-13-OZ	French Creek Renegade Web SRL	13'	B	Thermoplastic	4.1 lbs	400 lbs				\$169.99
7276WR	FallTech Dyneema Contractor Web SRL	20'	B	Thermoplastic	6.1 lbs	310 lbs			✓	\$264.99
42006	Guardian Velocity Web SRL	20'	B	Glass-filled nylon	5.6 lbs	310 lbs				\$329.99
3100431	Protecta Rebel Web SRL	20'	B	Thermoplastic	5.6 lbs	310 lbs			✓	\$229.99
3100433	Protecta Rebel Web SRL	20'	B	Thermoplastic	6.3 lbs	310 lbs				\$300.99
22426	Elk River Jaguar Web SRL	26'	B	Thermoplastic	9.1 lbs	310 lbs	✓			\$416.68
42008	Guardian Velocity Web SRL	40'	B	Glass-filled nylon	13.5 lbs	310 lbs	✓		✓	\$399.99

*Quickship SRL's typically ship within 24 hours after order has been confirmed.
LE = Leading Edge
Yellow highlighted rows are Gear Expert® recommended products.



CLASS
A

GUARDIAN DIABLO GRANDE CABLE SRL

Galvanized cable lifeline with ergonomic handle, swivel top and swivel snaphook, ANSI compliant.

42009 33' - \$514.99

42010 33' Leading edge, nylon coating with integrated shock absorber - \$565.99



CLASS
B



PROTECTA REBEL CABLE SRL

3/16" steel cable, shock-resistant thermoplastic housing, and self-locking swivel snaphook. ANSI compliant.

3590517 20' Galvanized steel cable - \$349.99

3590500 33' Galvanized steel cable - \$489.99

3590501 33' Stainless steel cable - \$449.99

3590550 50' Galvanized steel cable - \$489.99

3590630 85' Galvanized steel cable - \$1,024.99

3590670 100' Galvanized steel cable - \$1,289.99



CLASS
A



WESTFALL PRO SKYLOC II CABLE SRL

Lightweight, fiberglass reinforced, stackable nylon housing. Double-locking steel swivel snaphook. Load-bearing steel frame.

Exceeds Class A ANSI & OSHA requirements.

67030 30' - \$399.99

67050 50' - \$449.99

67100 100' - \$799.99

ITEM	DESCRIPTION	LENGTH	CLASS	HOUSING	WEIGHT	CAPACITY	RECERTIFIABLE	LE	QUICKSHIP*	PRICE
3590016	Protecta Rebel Cable SRL	11'	B	Nylon thermoplastic	6.6 lbs	310 lbs				\$239.99
3590019	Protecta Rebel Cable SRL	15'	B	Nylon thermoplastic	6.9 lbs	310 lbs			✓	\$269.99
42000	Guardian Velocity Cable SRL	16'	B	Glass-filled nylon	8.5 lbs	420 lbs			✓	\$304.99
3590517	Protecta Rebel Galvanized Cable SRL	20'	B	Nylon thermoplastic	12.6 lbs	420 lbs			✓	\$334.99
727620	FallTech Cable Contractor Cable SRL	20'	B	Glass-filled nylon	14.6 lbs	310 lbs			✓	\$361.99
42001	Guardian Velocity Cable SRL	20'	B	Glass-filled nylon	8.6 lbs	310 lbs				\$388.99
10910	Guardian Halo Cable SRL	20'	B	Aluminum	12.2 lbs	420 lbs				\$424.99
10912	Guardian Halo Cable SRL	25'	B	Aluminum	12.2 lbs	420 lbs	✓			\$457.99
42002	Guardian Velocity Cable SRL	30'	B	Glass-filled nylon	9.4 lbs	310 lbs	✓		✓	\$379.99
67030	WestFall Pro Skyloc II Cable SRL	30'	A	Fiberglass reinforced nylon	16 lbs	310 lbs	✓		✓	\$399.99
727630	FallTech Cable Contractor Cable SRL	30'	B	Glass-filled nylon	19.3 lbs	310 lbs	✓		✓	\$465.99
10915	Guardian Halo Cable SRL	30'	B	Aluminum	12.8 lbs	420 lbs	✓		✓	\$499.99
3504430	DBI Sala Ultra-Lok Cable SRL	30'	B	Glass-filled polyurethane	11 lbs	310 lbs	✓			\$1,028.99
3400853	DBI Sala Sealed Blok Cable SRL Retrieval / Bracket	30'	B	Aluminum, stainless steel	25 lbs	420 lbs	✓			\$3,029.99
3590500	Protecta Rebel Galvanized Cable SRL	33'	B	Nylon thermoplastic	13.5 lbs	420 lbs	✓		✓	\$489.99
3590501	Protecta Rebel Stainless Steel Cable SRL	33'	B	Nylon thermoplastic	13.5 lbs	420 lbs	✓		✓	\$422.99
42009	Guardian Diablo Grande Cable SRL	33'	A	Glass-filled nylon	16 lbs	420 lbs	✓			\$452.99
67050	WestFall Pro Skyloc II Cable SRL	50'	A	Fiberglass reinforced nylon	21 lbs	310 lbs	✓		✓	\$449.99
3590550	Protecta Rebel Galvanized Cable SRL	50'	B	Nylon thermoplastic	17.3 lbs	420 lbs	✓		✓	\$474.99
727650	FallTech Cable Contractor Cable SRL	50'	B	Glass-filled nylon	25.7 lbs	310 lbs	✓		✓	\$546.99
42003	Guardian Velocity Cable SRL	50'	B	Glass-filled nylon	15.6 lbs	310 lbs	✓			\$599.99
21970	Elk River Rescue & Recovery Cable SRL	50'	B	Composite	21 lbs	310 lbs	✓			\$1,741.34
3504450	DBI Sala Ultra-Lok Cable SRL	50'	B	Urethane thermoplastic	15 lbs	310 lbs	✓			\$1,364.99
3504550	DBI Sala RSQ Cable SRL With Rescue	50'	B	Urethane thermoplastic	19 lbs	310 lbs	✓			\$1,459.99
3400900	DBI Sala Sealed Blok Cable SRL	50'	B	Aluminum, stainless steel	29 lbs	420 lbs	✓			\$1,566.99
3591001	Protecta Rebel Retrieval Cable SRL	50'	B	Aluminum	26.3 lbs	310 lbs	✓			\$2,037.99
MR50GB-Z7	Miller Mightevac Cable SRL	50'	B	Aluminum alloy	31 lbs	310 lbs	✓			\$2,696.99
3400923	DBI Sala Sealed Blok Cable SRL Retrieval / Bracket	50'	B	Aluminum, stainless steel	31 lbs	420 lbs	✓			\$3,761.99
7281	FallTech 3-Way Retrieval Cable SRL	60'	B	Aluminum	39 lbs	310 lbs	✓			\$2,060.99
42004	Guardian Velocity Cable SRL	80'	B	Glass-filled nylon	27.8 lbs	310 lbs	✓			\$997.99
3590630	Protecta Rebel Galvanized Cable SRL	85'	B	Nylon thermoplastic	28.6 lbs	420 lbs	✓			\$1,024.99
3504485	DBI Sala Ultra-Lok Cable SRL	85'	B	Aluminum	33 lbs	310 lbs	✓			\$1,427.99
3400860	DBI Sala Sealed Blok Cable SRL	85'	B	Aluminum, stainless steel	44 lbs	420 lbs	✓			\$2,204.99
3400871	DBI Sala Sealed Blok Cable SRL Retrieval / Bracket	85'	B	Aluminum, stainless steel	58.7 lbs	310 lbs				\$4,804.99
67100	WestFall Pro Skyloc II Cable SRL	100'	A	Fiberglass reinforced nylon	35 lbs	310 lbs	✓		✓	\$799.99
42005	Guardian Velocity Cable SRL	100'	B	Glass-filled nylon	28.2 lbs	310 lbs	✓			\$1099.99
3590670	Protecta Rebel Galvanized Cable SRL	100'	B	Nylon thermoplastic	29.5 lbs	420 lbs	✓			\$1,372.99
MR100GB-Z7	Miller Mightevac Cable SRL	100'	B	Aluminum alloy	51 lbs	310 lbs	✓			\$3,254.99
3400965	DBI Sala Sealed Blok Cable SRL	130'	B	Aluminum, stainless steel	60 lbs	420 lbs	✓			\$3,104.99
MR130GB-Z7	Miller Mightevac Cable SRL	130'	B	Aluminum alloy	56 lbs	310 lbs	✓			\$3,597.99
3400871	DBI Sala Sealed Blok Cable SRL Retrieval / Bracket	130'	B	Aluminum, stainless steel	76.4 lbs	310 lbs	✓			\$4,541.99

*Quickship SRL's typically ship within 24 hours after order has been confirmed.
LE = Leading Edge
Yellow highlighted rows are Gear Expert® recommended products.





PROTECTA REBEL LEADING EDGE CABLE SRL

7/32" galvanized steel cable, swiveling self-locking snaphook, thermoplastic housing, fully integrated energy absorber, specially designed for foot level tie-off, carabiner included, ANSI compliant.

3590540 20' - \$489.99
3590543 33' - \$509.99

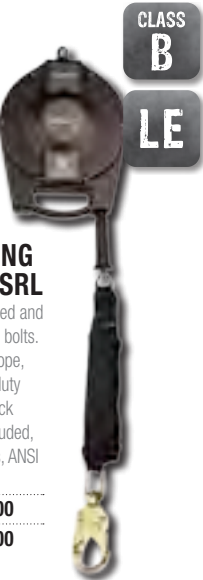

GUARDIAN DIABLO BIG BLOCK LEADING EDGE CABLE SRL

Built with a special coated and heat treated brake pawl bolts. 3/16" galvanized wire rope, lightweight and heavy-duty housing, integrated shock absorber, carabiner included, man-rated 130-420 lbs, ANSI compliant.

10968 50' - \$655.00
10967 65' - \$700.00



FALLTECH CONTRACTOR LEADING EDGE CABLE SRL

7/32" galvanized steel cable, internal inertial brake and external shock pack, glass-filled nylon housing, carabiner, load-indicating swivel carabiner, man-rated 310 lbs., ANSI compliant.

727620LE 20' - \$450.99
727630LE 30' - \$518.99
727650LE 50' - \$630.99



MSA V-SHOCK TWIN LEG ALUMINUM REBAR PFL

Incorporating the industry-leading patented spring radial energy absorber, the V-SHOCK Mini PFL is packed inside a rubberized armor and designed to take a beating in the roughest environments. ANSI compliant.

64111-00A 6' - \$399.99



MSA V-EDGE LEADING EDGE CABLE SRL

Integrated roll cage protect housing when used in foot-level tie off. Retraction dampening feature controls speed of the lifeline, preventing unwanted damage. Clear casing allows for quick, visual inspection of components. 310 lbs worker capacity. ANSI compliant.

63406-00A 20' - \$649.99

GEAR EXPERTS®

“ Our SRL Repair Center is now open! We are certified for srl repairs, inspections, and recertifications of all Falltech contractor and duratech series srls, srl-rs and winches. Our SRL Repair Center is able to offer a two day turnaround on all repairs (shipping time will vary). Contact our repairs center at 404-458-7000 or repairs@colsafety.com. ”



MIKE KROHN

Midwest Regional Sales Manager

ITEM	DESCRIPTION	LENGTH	CLASS	HOUSING	WEIGHT	CAPACITY	RECERTIFIABLE	LE	QUICKSHIP*	PRICE
64111-00A	MSA V-SHOCK Twin Leg Aluminum Rebar PFL	6'	B	Rubberized armor	3 lbs	310 lbs		✓	✓	\$399.99
727620LE	FallTech Contractor Leading Edge Cable SRL	20'	B	Glass-filled nylon	18 lbs	310 lbs		✓		\$450.99
3590540	Protecta Rebel Leading Edge Cable SRL	20'	B	Thermoplastic	17 lbs	310 lbs		✓	✓	\$489.99
10920	Guardian Halo Leading Edge Cable SRL	20'	B	Aluminum	12 lbs	310 lbs		✓		\$574.99
63406-00A	MSA V-Edge Leading Edge Cable SRL	20'	B	Polycarbonate	10.2 lbs	310 lbs		✓		\$599.99
10922	Guardian Halo Leading Edge Cable SRL	25'	B	Aluminum	14 lbs	310 lbs	✓	✓		\$624.99
727630LE	FallTech Contractor Leading Edge Cable SRL	30'	B	Glass-filled nylon	21 lbs	310 lbs	✓	✓		\$518.99
10925	Guardian Halo Leading Edge Cable SRL	30'	B	Aluminum	13.8 lbs	310 lbs	✓	✓	✓	\$649.99
3504500	DBI Sala Ultra-Lok Leading Edge Cable SRL	30'	B	Thermoplastic	16 lbs	310 lbs	✓	✓		\$1,299.99
RLS30G-Z7LE	Miller Mightylite Leading Edge Cable SRL	30'	B	Aluminum, steel	13 lbs	310 lbs	✓	✓		\$1,057.99
3590543	Protecta Rebel Leading Edge Cable SRL	33'	B	Thermoplastic	19 lbs	310 lbs	✓	✓		\$509.99
10968	Guardian Diablo Big Block Leading Edge Cable SRL	50'	B	Glass-filled nylon	17.4 lbs	420 lbs	✓	✓	✓	\$655.00
727650LE	FallTech Contractor Leading Edge Cable SRL	50'	B	Glass-filled nylon	25 lbs	310 lbs	✓	✓		\$630.99
10967	Guardian Diablo Big Block Leading Edge Cable SRL	65'	B	Glass-filled nylon	21 lbs	420 lbs	✓	✓		\$700.00

*Quickship SRL's typically ship within 24 hours after order has been confirmed.
 LE = Leading Edge



STERLING ANCORE SLING

Designed for creating personal fall arrest anchors. Constructed with a dual layer webbing with yellow outer jacket and an orange inner layer. The inner layer provides a visual indicator should the sling become damaged.

- SW254ANSL09024 24" - \$15.95
- SW254ANSL09036 36" - \$18.95
- SW254ANSL09048 48" - \$20.95
- SW254ANSL09060 60" - \$22.95
- SW254ANSL09072 72" - \$25.95
- SW254ANSL09096 96" - \$31.95

GEAR EXPERTS®

“ A GME exclusive, we've partnered with Sterling Rope to bring you an economical and unique fall arrest anchor sling. This sling is constructed with a dual layer webbing, a yellow outer jacket and an inner orange layer. This orange interior is a contrasting visual indicator to quickly identify any damage to the sling. The ANSI Z359.18 stamp and all weight ratings are encased in clear shrink wrap to prevent damage to the label. ”



TYLER NELSON
Southeast Regional Sales Manager



CMI HEAVY DUTY ANCHOR SLINGS

CMI Heavy Duty Anchor Slings are a continuous loop of 1" webbing that have an MBS rating of 14,000 lbs. They offer a safe working load of 2,800 lbs, as well as a choker rating of 13,900 lbs and a v-basket configuration rating of 29,000 lbs. Also available in Orange.

- AAS24HD 24" - \$12.50
- AAS36HD 36" - \$13.95
- AAS48HD 48" - \$15.50
- AAS60HD 60" - \$19.25
- AAS72HD 72" - \$20.40
- AAS96HD 96" - \$24.00



GO TO WWW.GMESUPPLY.COM/ANCHORAGE TO VIEW ALL ANCHORAGE



WESTFALL PRO DYNEEMA ANCHOR SLING WITH RING

3/4" Dyneema web construction for weight savings and extra durability, aluminum O-ring for pass-thru anchorage. Heavy-duty label cover to protect inspection and product information. Rated for one 310 lb user. Meets ANSI Z359.1 and OSHA 1926.502.

- 711601 17" - \$27.99
- 711602 24" - \$32.99
- 711603 36" - \$41.99
- 711606 72" - \$66.99



GUARDIAN PREMIUM CROSS ARM STRAP

Twice as durable with dual enforced webbing and heavy-duty stitching. Heavy-duty wear pad protects the structural webbing against abrasion and snags. Large D-ring and standard size D-ring for pass-thru.

- 10785 3' - \$20.99
- 10786 4' - \$22.99
- 10787 6' - \$31.99
- 10788 8' - \$35.99
- 10790 10' - \$39.99
- 10791 12' - \$49.99
- 10792 15' - \$53.99



ELK RIVER EZE-MAN SLING

Triangle end, 1-3/4" x 2' with D-rings end. Made with nylon and polyester webbing and wear pad.

- 26772 1-3/4" x 2' - \$45.11
- 26773 1-3/4" x 3' - \$46.98
- 26774 1-3/4" x 4' - \$48.84
- 26776 1-3/4" x 6' - \$52.39



FALLTECH WEB PASS-THRU ANCHOR

Heavy-duty 1-3/4" polyester webbing with rugged forged alloy-steel hardware. 3" wear pad protects primary webbing from cuts and abrasion. Ideal for I-beams and other properly rated structural members.

- 7324 1-3/4" x 2' - \$27.99
- 7336 1-3/4" x 3' - \$29.99
- 7348 1-3/4" x 4' - \$31.99
- 7372 1-3/4" x 6' - \$37.99
- 737210 1-3/4" x 10' - \$39.99





FRENCH CREEK PARAPET WALL ANCHOR

Designed to provide a single worker with a portable, temporary anchorage on parapet walls up to 20" thick. Applications include window washing, construction, emergency & rescue situations, and more. Features one padded fixed leg and one padded adjustable leg (with multiple pin sets & adjustable mounting pad), the unit can be sized and secured without the use of tools.

1789 - \$299.99



ELK RIVER EAGLE TIE-OFF SLING

Wear pad is made from nylon, features a 4" half loop eye on each end, man-rated to 310 lbs, 1" wide x 3' long.

63673 36" - \$41.18



GUARDIAN TWO-WAY UNIVERSAL STANDING SEAM ROOF CLAMP

Lightweight, reusable, durable, and easy-to-use. The clamp also features a unique, reversible design that allows for seams up to 1" wide. The MR-24, VSR or similar profiles can be covered with one clamp.

10600 - \$224.99



DBI SALA WEB TIE-OFF ADAPTOR

Pass-thru type tie-off adaptor. Durable polyester construction. Abrasion resistant polyester wear pad. High-strength steel hardware. Compact and lightweight design.

1003000 3' - \$51.99

1002004 4' - \$54.99

1003006 6' - \$56.99

1002010 10' - \$74.99



DBI SALA D-RING WITH ANCHOR PLATE

Bolt or weld to structure for fall arrest anchor point; compact 1/4" x 2" x 4-1/2" (6 x 51 x 114 mm) 304 stainless steel plate; pre-drilled 1/2" (12.7 mm) holes; zinc plated steel D-ring for compatible tie-off point; high strength steel construction; extremely rugged and corrosion resistant; capable of supporting a load of 5,000 lbs (22 kN) or of meeting OSHA's criteria of a 2-to-1 safety factor.

2101630 - \$41.99



GUARDIAN RIDGE-IT SAFU ANCHOR

Made of stainless steel, the SAFU Anchor has a D-ring on each end. Compliant with all OSHA and ANSI standards. For permanent installation on wood rooftops. Manufactured with butyl strips, the SAFU is waterproof and includes fasteners.

00510 18" - \$36.99



DBI SALA CONCRETE D-RING ANCHOR

Installs into 11/16", 18 mm, or 3/4" concrete hole; use vertically in wall or horizontally in ceiling; install as temporary or permanent anchor; reusable D-ring assembly; safe hook-up indicator; compact and lightweight design; high strength steel and aluminum construction; rugged and corrosion resistant materials; swiveling D-ring tie-off point; capable of supporting a load of 5,000 lbs (22 kN) or of meeting OSHA's criteria of a 2-to-1 safety factor.

2104560 - \$103.99



GUARDIAN BOLT HOLE ANCHOR

Reusable 5,000 lbs anchor point. Easy to install, no tools required. Fits holes 3/4" to 1-1/4". Can be used vertically or horizontally. Squeeze to twist lock, release to activate lock.

00230 - \$159.99



WESTFALL PRO 3/4" CONCRETE ANCHOR

Easily installed and removed for reuse at another location. Designed for use in concrete only and offers an MBS of 5,000 lbf (22 kN). Use in horizontal, vertical, and overhead surfaces for fall protection, restraint, and working positioning. ANSI compliant.

7006 - \$89.99





GUARDIAN BEAMER 2000

Designed specifically for use at your feet and overhead. Nylon bushings provide smooth movement. Lightweight and glides easily in both directions. Fits beam width from 3-1/4" - 14" and up to 1-1/4" thick. Welding spatter does not stick to aluminum bar. No tools necessary for fast installation. One-handed operation.

00101 Without D-ring swivel - \$174.99

00102 With D-ring swivel - \$179.99



WESTFALL PRO BEAM ANCHOR

Made from aircraft aluminum the beam anchor is lightweight. Features a swivel D-ring on top, and is removable and reusable. Fits beam 3-1/2" - 12". 5,000 lbf breaking strength, 22 kN, 310 lbs weight capacity. ANSI compliant.

7007 - \$149.99



FALLTECH CABLE PASS-THROUGH

Pass-through sling anchor with (2) O-rings for easy installation. 1/4" vinyl coated galvanized cable. Ideal for I-beams and other properly rated structural members, particularly in harsh environments.

7427 4' - \$45.99

7428 6' - \$46.99

742808 8' - \$47.99

742810 10' - \$49.99

742712 12' - \$51.99



GUARDIAN SINGLE USE CONCRETE ANCHOR STRAP

Inexpensive anchor solution. Disposable and intended for one time use only. Make sure that anchor strap is attached to a structure capable of supporting 5,000 lbs. Sheathed in heavy duty nylon webbing.

10710 3' - \$9.49

10715 4' - \$10.49

10717 6' - \$111.49



GUARDIAN ANCHOR POINT

Permanent installation onto wood, steel, and concrete substrates (fasteners are for wood and steel applications). Features a 12" anchor post that extends so that it is accessible during and after construction. Use this roof anchor with horizontal lifelines, vertical lifelines, SRLs, and lanyards. Made from galvanized steel, making it extremely durable. Post extends past roofing substrate to attachment point accessible. Round post works with most off-the-shelf flashing kits. 130 - 420 lbs worker capacity range, 5,000 lbs minimum breaking strength, ANSI compliant.

CB-12

00645 Anchor & choice of wood or metal fasteners - \$274.99

00668 40 Wood fasteners - \$7.99

00669 40 Metal fasteners - \$13.99

CB-18

00656 Anchor point for concrete (no swivel) - \$309.99

00657 Anchor point for wood or metal (no swivel) - \$339.99

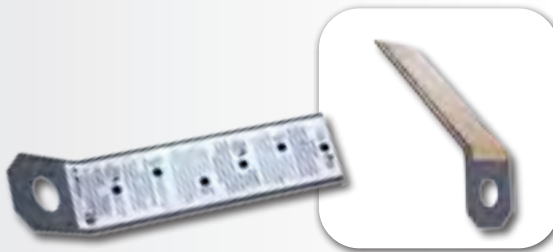

SUPERANCHOR D-MINUS ANCHORS

(10) Gray powder coated 11-gauge steel anchors, SST nails, and 7" butyl flashing strips.

1076 Gray, 10 pack - \$95.00



GUARDIAN TEMPER REUSABLE ROOF ANCHOR

Reusable anchorage connector designed for temporary use on wood rooftops, fits all roof pitches from flat to 12/12, composed of thick plated steel for longer lasting product life, can be installed with either screws or duplex nails (depending on roof pitch), designed offset holes down the center.

00455 - \$22.99



PROTECTA PRO-LINE TEMPORARY HORIZONTAL LIFELINE SYSTEM

60' lifeline with tensioner, shock absorber, bag, and (2) 6' tie-off adaptors. Built-in shock absorber limits arresting forces during a fall and provides the user with a visual impact indicator. Installs in seconds without special tools or equipment. Fall arrest rated for two users, OSHA compliant.

1200101 With tie-off adaptors - \$374.99

1200105 Without tie-off adaptors - \$279.99



GUARDIAN RETRACTABLE HORIZONTAL LIFELINE

Combines the span flexibility of synthetic-rope HLLs with the durability of fixed-length cable HLL systems. Features an integrated shock absorber and can accommodate up to two workers in fall arrest. The ergonomic carry handle and spool release make paying out the lifeline easy and snag-free. Its unique unidirectional design prevents unwanted spinning during payout, and has a 1/4" hex shaft that accommodates a cordless drill for ultra-fast retraction if desired.

04660 - \$2,200.00



GEAR EXPERTS®

“Ease of use on a job site is more than just convenience, it ensures that equipment is being properly used to keep workers safe and productive on the job. The EZ-Line has an innovative retractable design that allows the user to quickly set up a system, and in seconds dismantle it for use in another location. Retracting the whole lifeline into an easy to carry case makes for easy transport and no storage headaches.”



MIKE KROHN
Midwest Regional Sales Manager

DBI SALA EZ-LINE RETRACTABLE HORIZONTAL LIFELINE

60' retractable system can be set at any length, rugged 1/4" 7 x 19 galvanized cable lifeline, ergonomic easy to carry case, extremely lightweight and portable design, built-in winch, pre-tension and impact indicators, durable construction will stand up to tough job sites, single and multi-span (with SecuraSpan stanchion) system configurations, internal energy absorber limits fall arrest forces, flexible system capacity, use with any 5,000 lbs anchorage device, equipped with i-Safe.

7605060 - \$1,199.99

MILLER TECHLINE TEMPORARY HORIZONTAL LIFELINE SYSTEM KIT

A premium temporary horizontal rope lifeline systems for two workers. An in-line system shock absorber reduces forces while O-ring connections allow for ease of mobility. The systems are quick and easy to install, lightweight and portable.

HLLR2-Z7/30FT 30' Rope - \$536.99

HLLR2-Z7/60FT 60' Rope - \$778.99



GUARDIAN CABLE HORIZONTAL LIFELINE SYSTEM

Designed to support up to (2) workers in fall arrest applications; includes 100' span of 3/8" diameter cable, (2) cross arm strap anchorage connectors, (1) web tensioner, (3) cable clamps, and (1) impact attenuator.

04800 - \$1,014.99



CONNECTORS 101

COMPLIANCE

This stamp clearly identifies the standard which the hardware is manufactured to follow. Typically ANSI Z359.1-2007 or Z359.12, although there may also be CSA or EN ratings stamped, as well.

LOAD RATING

A load rating should be stamped on the long axis of the hardware. This shows what the minimum break strength of the hardware is, typically displayed in pounds, tons, or kN.

MANUFACTURER MARKINGS

ID's who made the hardware, lot #'s and other codes to help identify when, where, and who made the thing. These aren't as much as a safety feature, as they are for troubleshooting if there's ever a bad batch from the manufacturer.

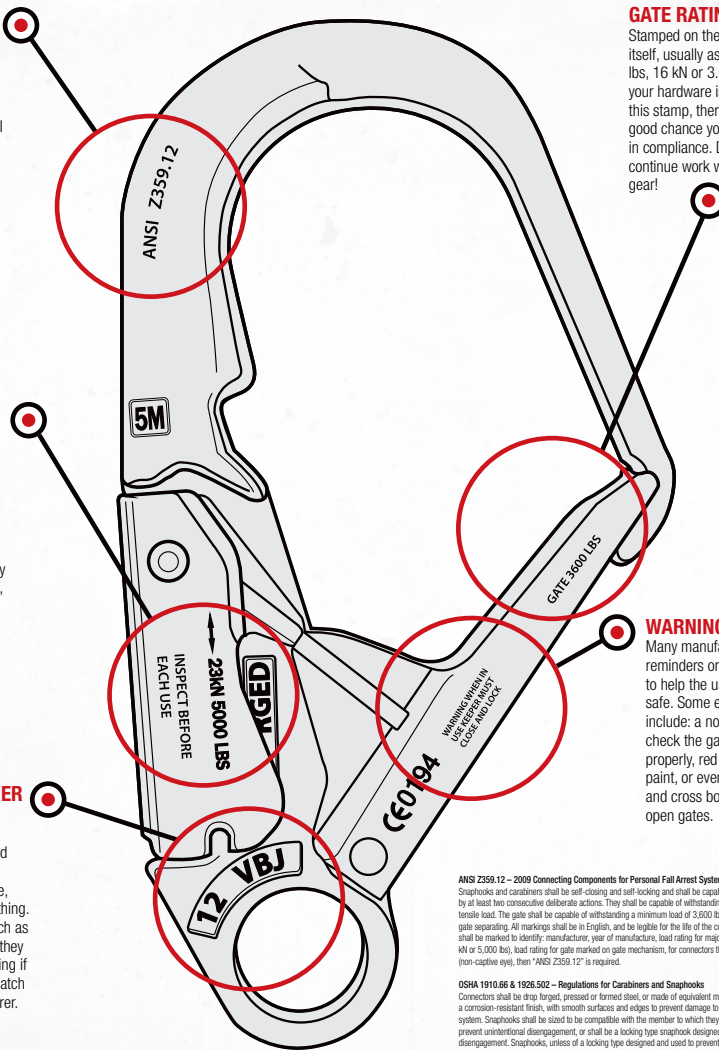

GATE RATINGS

Stamped on the gate itself, usually as 3,600 lbs, 16 kN or 3.6 m. If your hardware is missing this stamp, there's a good chance you're not in compliance. Don't continue work with this gear!

WARNINGS

Many manufacturers put reminders or warnings to help the user stay safe. Some examples include: a note to double check the gate is closed properly, red warning paint, or even a skull and cross bones logo for open gates.

ANSI Z359.12 - 2009 Connecting Components for Personal Fall Arrest Systems
Snaphooks and carabiners shall be self-closing and self-locking and shall be capable of being opened only by at least two consecutive deliberate actions. They shall be capable of withstanding a 5,000 lbs. (22.2kN) tensile load. The gate shall be capable of withstanding a minimum load of 3,600 lbs (16kN) without the gate separating. All markings shall be in English, and be legible for the life of the component. Connectors shall be marked to identify manufacturer, year of manufacture, load rating for major axis (minimum of 22 kN or 5,000 lbs), load rating for gate marked on gate mechanism, for connectors that are non-integral part (non-captive eye), then "ANSI Z359.12" is required.

OSHA 1910.66 & 1926.502 - Regulations for Carabiners and Snaphooks
Connectors shall be drop forged, pressed or formed steel, or made of equivalent materials. They shall have a corrosion-resistant finish, with smooth surfaces and edges to prevent damage to interfacing parts of the system. Snaphooks shall be sized to be compatible with the member to which they are connected so as to prevent unintentional disengagement, or shall be a locking type snaphook designed and used to prevent disengagement. Snaphooks, unless of a locking type designed and used to prevent disengagement from the following connections, shall not be engaged: directly to webbing, rope or wire rope; to each other; to a D-ring to which another snaphook or other connector is attached; to a horizontal lifeline; or to any other object which is incompatibly shaped or dimensioned in relation to the snaphook such that the connected object could depress the snaphook keeper a sufficient amount to release itself.

GEOMETRY

During normal work, connectors move around on anchorage points. If your hardware isn't designed to be used with your anchorage point, or doesn't have proper safety features, the gate could make contact with the anchorage point and potentially work its way open. Be sure your connector and anchorage point are compatible. This risk is magnified when the connection is at foot level.

TENSION DIRECTION

Snaphooks and carabiners are designed to be loaded on their long axis. Loading them incorrectly may lead to failure. Always be sure your hardware is being loaded in the proper direction. If you're at risk of cross loading, or applying tension on the short axis, don't continue working.

ONE AT A TIME

Connectors are designed to go solo. Attaching two snaphooks or carabiners to a single D-ring may cause problems. They can act on each other causing one to slip open, or get twisted up, causing damage. Remember, one per anchorage point!

LOAD RATING

Hardware made for lifting and rigging will have a Working Load Limit, often abbreviated as WLL on the hardware, stamped in the metal. This means the hardware has been tested to be able to maintain a static load up to that rating. This rating can be listed in lbs, tons, or even kN. Don't use carabiners designed for fall protection for lifting and rigging!

ANSI

ANSI Z359 compliant connectors are almost universally recommended. Hardware that has this standard will have gates rated to 3,600 lbs. This helps ensure the gate will not fail if loading occurs. Multi-action gates are also required. To open, there must be at least two separate actions made to release the mechanism. Look for the ANSI stamp before using the gear.

INSPECTING CONNECTORS

GATE FUNCTION

Check the gate for smooth operation. It should open smoothly. When released, it should close and lock properly. When closed, move gate back and forth to see if there is excess movement. If it catches, grinds, doesn't close properly, or is difficult to operate, remove the unit from service.

DEFORMITY

Check the axis of the unit for signs of overloading or deformity. Any stretching, or stress marks warrant removal from service.

RUST/CORROSION

Look over the unit for any signs of corrosion or rust. ANSI Z359 connectors use a zinc coating for protection that wears off during normal use. Once the zinc begins to show signs of pitting or corrosion remove from service.

MARKINGS

If any of the ratings normally stamped on the hardware are worn off, the unit must be retired.

PHYSICAL DAMAGE

Inspect for any significant dents, nicks, cuts or gouges to the carabiner or snaphook. These can be indications of improper use.

THE MANY SHAPES, FUNCTIONS, AND DESIGNS OF CONNECTORS

There are many designs of connectors. From all the different shapes and materials of carabiners, to snaphooks and rebar hooks. Some have swivels, some have double and even triple action locking mechanisms. Made from steel, aluminum, or other alloys, they can be designed for fall protection, lifting and rigging, or maybe just to quickly connect two objects and not made for safety at all! Be sure you have the proper piece of hardware for the job at hand... If you're not sure, give our Gear Experts® a call and we'll make sure you're in the clear!



PURCHASE THE
19" x 27" POSTER FOR

\$4.99

PART # 2202



KITS
SAVE
CASH

GME SUPPLY CONNECTOR PACKAGE

Add-on this package to easily get all the carabiners and hardware you need to go along with your tower climbing gear. Package includes WestFall Pro Spreader Bar, (2) WestFall Pro 4-7/8" x 3" 7400 carabiners, and (2) WestFall Pro 7" x 3-3/4" 7420 carabiners.

90110 - \$134.99



KITS
SAVE
CASH

GME SUPPLY CARABINER VARIETY PACK

Buy in bulk and save, pack of 10 includes our most popular carabiners: (4) 4-7/8" x 3" 7400 carabiners; (2) 4-1/2" x 2-3/4" 7405 carabiners; (2) 7" x 3-3/4" 7420 carabiners; (2) 7" x 4-1/2" 7430 carabiners.

CARABINERPACK - \$249.99



VIDEO

7440



VIDEO

7430



VIDEO

7425

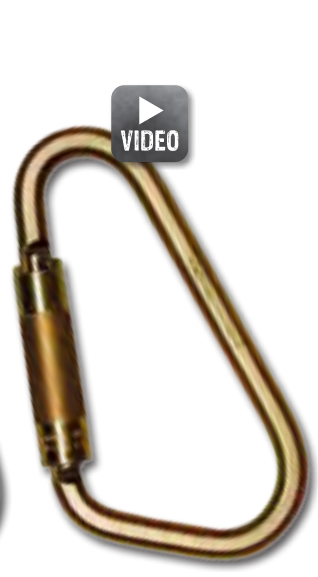

VIDEO

7420



VIDEO

7435



7436



7437



7465



7466

VIEW OUR
ENTIRE SELECTION
ONLINE AT
GMESUPPLY.COM



All hardware qualifies for quickship

PART	DESCRIPTION	LENGTH	WIDTH	WEIGHT	GATE	MBS	CERTIFICATION	PRICE
7440	WestFall Pro Steel Carabiner	8-5/8"	5-1/8"	1.75 lbs	2"	35 kN	ANSI Z359-12-2009	\$39.99
7430	WestFall Pro Steel Carabiner	7-1/2"	4-1/2"	1.80 lbs	2-1/4"	45 kN	ANSI Z359-12-2009	\$39.99
7425	WestFall Pro Steel Carabiner	7-1/8"	4-1/2"	1.25 lbs	1-1/8"	50 kN	ANSI Z359-12-2009	\$34.99
7420	WestFall Pro Steel Carabiner	7"	3-3/4"	1.00 lbs	1-3/4"	35 kN	ANSI Z359-12-2009	\$34.99
7435	WestFall Pro Aluminum Carabiner	4-3/4"	3"	0.22 lbs	9/10"	25 kN	ANSI Z359-12-2009	\$27.99
7436	WestFall Pro Aluminum Carabiner	4-7/8"	3-1/8"	0.32 lbs	7/8"	30 kN	ANSI Z359-12-2009	\$29.99
7437	WestFall Pro Aluminum Carabiner	4-7/8"	3"	0.28 lbs	13/16"	23 kN	ANSI Z359-12-2009	\$29.99
7465	WestFall Pro Snaphook	5"	2-1/4"	0.85 lbs	3/4"	23 kN	ANSI Z359-12-2009	\$19.99
7466	WestFall Pro Swivel Snaphook	7-1/16"	2-1/4"	1.10 lbs	3/4"	23 kN	ANSI Z359-12-2009	\$34.99

Captive eye pin quick tip, call our Gear Experts® for more information.

Captive eye pins are a simple device that can make a huge difference. When installed, they will limit any attached rope or device from sliding the length of the carabiner.

GO TO WWW.GMESUPPLY.COM/HARDWARE TO VIEW ALL CARABINERS & HARDWARE



All hardware qualifies for quickship

PART	DESCRIPTION	LENGTH	WIDTH	WEIGHT	GATE	MBS	CERTIFICATION	PRICE
7400	WestFall Pro Steel Carabiner	4-7/8"	3-1/8"	0.62 lbs	1-1/16"	45 kN	ANSI Z359-12-2009	\$25.99
7401	WestFall Pro Steel Carabiner	4-7/8"	3"	0.66 lbs	1"	50 kN	ANSI Z359-12-2009	\$25.99
7405	WestFall Pro Steel Carabiner	4-1/2"	2-3/4"	0.55 lbs	3/4"	41 kN	ANSI Z359-12-2009	\$23.99
7406	WestFall Pro Steel Carabiner	5-1/4"	3-1/2"	0.80 lbs	3/4"	50 kN	ANSI Z359-12-2009	\$25.99
7410	WestFall Pro Steel Carabiner	3-1/4"	1-1/8"	0.50 lbs	1/2"	30 kN	ANSI Z359-12-2009	\$22.99
7460	WestFall Pro Aluminum Carabiner	8-5/8"	5-1/8"	1.00 lbs	1-1/5"	25 kN	ANSI Z359-12-2009	\$56.99
7475	WestFall Pro Separator Spreader Bar Snaphook	9-3/4"	2-1/4"	1.60 lbs	3/4"	22.2 kN	ANSI Z359-12-2009	\$42.99
13450	Elk River Separator Spreader Bar Snaphook	9-3/4"	2-1/4"	1.65 lbs	3/4"	22.2 kN	ANSI Z359-12-2009	\$42.99
7450	WestFall Pro Rebar Hook	9"	4-2/3"	1.32 lbs	2-1/2"	23 kN	ANSI Z359-12-2009	\$35.99
7455	WestFall Pro Swivel Rebar Hook	11-1/4"	5-1/8"	1.55 lbs	2-1/2"	23 kN	ANSI Z359-12-2009	\$49.99
7452	WestFall Pro Steel Rebar Hook	9-3/5"	5-3/20"	1.75 lbs	2-11/20"	23 kN	ANSI Z359-12-2009	\$39.99
7451	WestFall Pro Aluminum Rebar Hook	9-4/5"	5-3/10"	1.50 lbs	2-1/2"	23 kN	ANSI Z359-12-2009	\$54.99



C1A



C2A



C3A

*** Specialty gate options available. Call our Gear Experts® for more information.**

All hardware photos are proportionately scaled. These Non-ANSI rated connectors are not rated to be used in a fall arrest system in the tower climbing industry, although they may be acceptable in other industries.

SEE BLACK CARABINERS ON PAGE 106



M36A SL



M34A RL



M33A TL



SM103100N



HWSAFEDTL

PART	DESCRIPTION	BLACK COLOR OPTION	LENGTH	WIDTH	WEIGHT	GATE	MBS	PRICE
C1A	Rock Exotica Pirate Auto Lock Aluminum Carabiner	✓	4.2"	2.8"	0.19 lbs	1"	26 kN	\$19.00
C1S	Rock Exotica Pirate Screw Lock Aluminum Carabiner	✓	4.2"	2.8"	0.18 lbs	1"	26 kN	\$14.00
C2A	Rock Exotica RockD Auto Lock Aluminum Carabiner	✓	4.5"	2.7"	0.20 lbs	0.95"	29 kN	\$19.00
C2S	Rock Exotica RockD Screw Lock Aluminum Carabiner	✓	4.5"	2.8"	0.16 lbs	0.95"	29 kN	\$14.00
C2T	Rock Exotica RockD Twist Lock Aluminum Carabiner		4.5"	2.8"	0.18 lbs	0.95"	29 kN	\$19.00
C3A	Rock Exotica RockO Auto Lock Aluminum Carabiner	✓	4.4"	2.5"	0.17 lbs	0.9"	24 kN	\$19.00
C3S	Rock Exotica RockO Screw Lock Aluminum Carabiner	✓	4.2"	2.8"	0.16 lbs	0.93"	24 kN	\$14.00
M36A TL	Petzl William Triact Lock Aluminum Carabiner	✓	4.5"	3.0"	0.20 lbs	1.06"	27 kN	\$21.95
M36A BL	Petzl William Ball Lock Aluminum Carabiner		4.5"	3.0"	0.20 lbs	1.06"	27 kN	\$21.95
M36A SL	Petzl William Screw Lock Aluminum Carabiner	✓	4.6"	3.1"	0.20 lbs	1.1"	27 kN	\$17.95
M34A RL	Petzl Am'D Twist Lock Aluminum Carabiner		4.3"	2.5"	0.20 lbs	0.98"	27 kN	\$20.95
M34A TL	Petzl Am'D Triact Lock Aluminum Carabiner	✓	4.5"	2.5"	0.17 lbs	0.94"	27 kN	\$20.95
M34A BL	Petzl Am'D Ball Lock Aluminum Carabiner		4.5"	2.5"	0.17 lbs	0.98"	27 kN	\$20.95
M34A SL	Petzl Am'D Screw Lock Aluminum Carabiner	✓	4.4"	2.4"	0.17 lbs	0.91"	27 kN	\$15.95
M33A TL	Petzl OK Triact Lock Aluminum Carabiner	✓	4.3"	2.5"	0.17 lbs	0.87"	25 kN	\$18.95
M33A BL	Petzl OK Ball Lock Aluminum Carabiner		4.4"	2.6"	0.17 lbs	1"	25 kN	\$18.95
M33A SL	Petzl OK Screw Lock Aluminum Carabiner	✓	4.4"	2.6"	0.15 lbs	1"	25 kN	\$13.95
SM103100N	SMC Kinetic Dual Lock Carabiner		4.6"	2.9"	0.21 lbs	0.98"	28 kN	\$20.99
HWSAFEDTL	Sterling Rope SafeD Twist Lock Carabiner With Lanyard Pin		4.4"	2.5"	0.20 lbs	1.05"	28 kN	\$30.99
C81A	Rock Exotica SwivaBiner Auto Lock Aluminum Carabiner	✓	7.3"	2.6"	0.36 lbs	0.84"	30 kN	\$88.00
C82A	Rock Exotica SwivaEye Auto Lock Aluminum Carabiner	✓	5.4"	2.6"	0.30 lbs	0.84"	30 kN	\$78.00
MG00-60	Petzl MGO Open 60 Connector		8.9"	3.9"	1.08 lbs	2.48"	23 kN	\$69.95



CARABINER GATE MECHANISMS

Carabiner gates come in a few different varieties. For tower climbing, the most common is the twist lock, but some other work may require another variety of gate function.

SCREW-LOCK

The screw-lock operates by unscrewing the sleeve down the gate to open. This gate will not auto-lock, as the sleeve has to be manually tightened after the gate snaps shut.

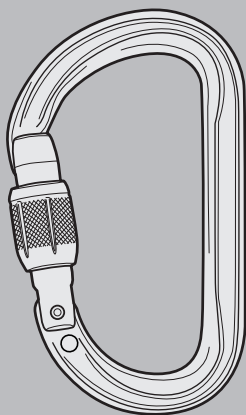
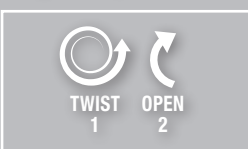

TWIST-LOCK

The twist-lock is a double action gate that quickly opens with a simple twist and pull movement. These are common on ANSI carabiners on pages 50-51.

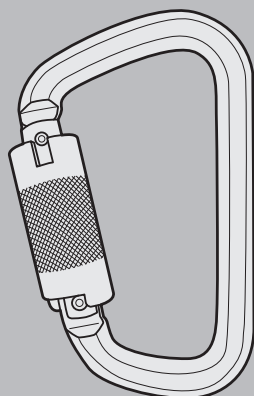

AUTO-LOCK

This is a three stage design as it requires 3 different motions to open. First you pull the sleeve down, then twist, then pull back to open. Some carabiners only twist one direction, while others can twist left or right.

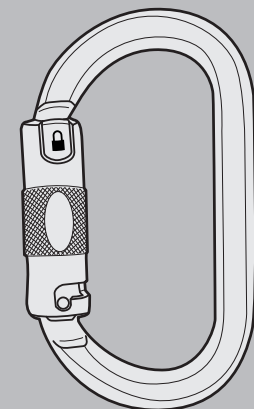

ROCK EXOTICA SWIVABINER AUTO LOCK ALUMINUM CARABINER

0.37 lbs. Consists of two, swiveling carabiners. Innovative design, the C81A eliminates the need for a separate swivel and two carabiners. Decreases the length and the weight of your set-up. Designed for orientation of a load, not for high RPM applications.

C81A - \$88.00

ROCK EXOTICA SWIVAEYE AUTO LOCK ALUMINUM CARABINER

0.34 lbs. Combines a swivel and a carabiner into one device. This SwivEye device will decrease the length and the weight of your set-up. The carabiner end and swivel eye are machined out of solid aluminum and are connected by a sealed ball bearing and a stainless steel axle.

C82A - \$84.00

SKYLOTEC DOUBLE-O TRI CARABINER

0.19 lbs. 4.29" H, 2.28" W, 0.83" gate opening. 24 kN major axis breaking load. This oval carabiner with 180° technology and smooth triple-locking mechanism for maximum safety. For workers who climb and work left-handed or use both hands. With the innovative design (180° spring rotation), the sleeve that closes the gate can rotate in both directions.

H-176-TRI - \$30.99

PETZL MGO OPEN CONNECTOR

1.1 lbs. This auto-locking, directional connector features a large gate opening for connecting to metal structures or large diameter cables and bars. 23 kN major axis strength, and 63 mm gate opening.

M080AA00 MGO Open 110 - \$129.95

MGO0 60 MGO Open 60 - \$74.95



M080AA00

MGO0 60

PETZL EASHOOK OPEN CONNECTOR

0.4 lbs. The Eashook Open carabiner is designed for use at the ends of a double lanyard or work positioning lanyard. The gated connection point allows for direct attachment of the carabiner to the lanyards. If the lanyard is damaged, the connector can thus be reused. The excellent grip and automatic locking system facilitate handling when passing intermediate anchors.

M043AA00 Gray & yellow - \$39.95

M043AA01 Black - \$41.95



PETZL RING OPEN MULTI-DIRECTIONAL GATED RING

0.15 lbs. Designed for connecting equipment to your harness. The round shape ensures functionality in all directions. With an extra wide opening, it's easy to install ropes with sewn terminated ends. 2.7" outside diameter, 1.8" inside diameter, 0.5" opening.

P28 - \$24.95



ROPE 101

ROPE CONSTRUCTION

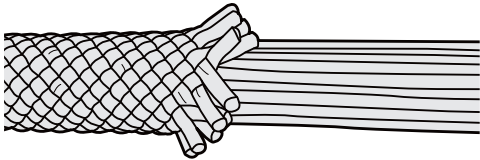

Kernmantle (Pages 56 & 57) - Kernmantle rope consists of twisted parallel fibers (the kern) surrounded by a tightly braided sheath (the mantle). The core fibers provide the majority (about 70%) of the rope's strength. The sheath is tightly braided providing significantly higher abrasion resistance. There are two distinct types of kernmantle: dynamic and static. Dynamic is used for recreational climbing due to its high shock absorption capabilities. Static kernmantle has very low stretch and works well for industrial applications. Due to its construction, it remains round through descent devices and allows minimal twist on the rope. The properties of static kernmantle make it ideal for use as a life line or descent line.

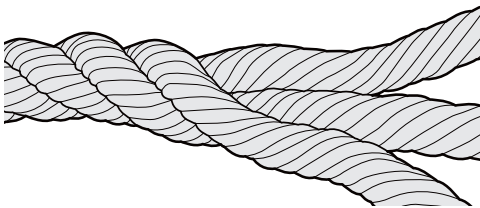

3-Strand (Page 58) - 3-Strand ropes are an inexpensive rope option. They tend to have a lower breaking strength than double braid or kernmantle, so a larger diameter must be used to achieve the same strength. Due to their construction, 3-Strand ropes have a tendency to rotate under load and provide less abrasion resistance. These characteristics make it a poor load line. With regard to safety and working at height, 3-Strand is most commonly used as a lifeline due to compliance with OSHA requirements and compatibility with 5/8" rope grabs.

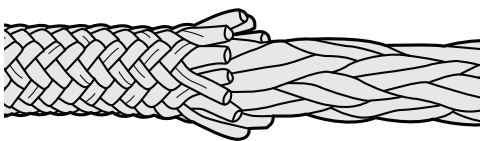

Double Braid (Page 86) - Double braided rope is, as the name implies, a braided core surrounded by a braided sheath. The inner and outer braids are generally designed

to share the load equally with very low elongation. Double braid rope remains round under tension, imparts no rotational force when loaded and has a soft hand. These characteristics make it ideal for use as a load rope.

DIAMETER

As ropes get thicker, they get stronger. But there's a misconception that to be as safe as possible you should get the thickest rope available. In reality, your rigging is only as strong as your weakest component. The capstan, shackles, slings, blocks, and rope all must be considered. If you're using a 1,000 pound capstan hoist, most 1/2" Double Braids have an MBS high enough to safely handle the maximum load for the hoist; even with the safety factor, and any loss of strength due to knots, termination plates, or sewn eyes. While a 5/8" rope has a higher breaking strength, it would not matter since the hoist is only capable of lifting 1,000 pounds. Another thing to consider is the sheave diameter of the blocks being used. There are many options which can handle 1/2" synthetic rope, but few exist that are strong enough to justify 5/8" rope.

INSPECTION

Each time you use your rope, you should perform a visual inspection to ensure it's safe to use. Check for cuts, nicks, burns, excess fraying, flat or uneven spots, burns, harness, glossing, discoloration from sun exposure or chemicals, or inconsistencies in the rope. Refer to the manufacturers recommendations for complete inspection and usage instructions. Use a rope log, like the one available on www.gmesupply.com/learn to keep a complete record of inspections.

Another practice which is becoming more common is individual serial numbers for rope. This permanent label is useful to document when a rope goes into service, as well as track inspections. This label should contain the type of rope, manufacturer information, date of manufacturing, and markings to denote break strength.

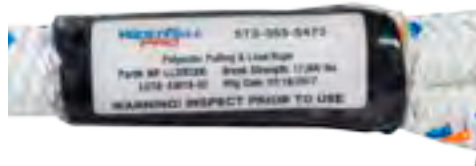

Have additional rope questions? Give our Gear Experts® a call @ (800) 940-6762!

FREE
DOWNLOAD

ROPE DIAMETERS

6 mm

7 mm

8 mm

5/16"

9 mm

3/8"

10 mm

11 mm

7/16"

12 mm

1/2"

13 mm

14 mm

15 mm

16 mm

5/8"

17 mm

18 mm

19 mm

3/4"

ROPE 201

FREE
DOWNLOAD

KNOTS

While tying knots is a very important skill to have when working with rope, it's equally important to recognize the effects they have. Knots can seriously decrease the overall strength of the rope, not only while the knot is tied in the rope, but even after the knot has been untied. This is due to crimping and twisting that is often irreversible.

Knots can decrease rope strength by up to 50%, which could be catastrophic in a life safety or overhead lifting and rigging scenario. Studies have shown that a figure 8 knot, one commonly used to create a looped termination at the end of a rope, causes ropes to break at 75-80% of their typical strength. This decrease in MBS could be enough to put the capacity below required safety factors.

A common reason knots are tied in ropes is to create an attachment point to secure a rope to a structure or object. There are other options available, which do not decrease the strength of the rope by nearly as much as a knot.

RETIRING YOUR ROPE

Reasons to retire your rope immediately:

- Rope whose strength may have been compromised during use
- Rope which is subjected to uncontrolled or excessive loading
- Rope which is greater than 10 years old, regardless of history & usage
- Rope whose history and past usage you are uncertain about
- Rope that has been exposed to heat, direct flame, or excessive abrasion

Cut retired rope into short lengths to discourage future use - or discard it entirely. A retired rope should not be stored, kept, or maintained in such a way that it could inadvertently be used.



Pictures above showcase damaged rope cores and frayed/abraded sheath

TERMINATION OPTIONS



Termination Plates - A piece of hardware, typically made from milled aluminum, which has multiple holes. Rope is fed through these holes in a specific pattern, leaving the main hole at the end of the plate as an attachment point.



Factory Sewn or Spliced Eyes - Many rope manufacturers offer sewn eyes for kernmantle and double braid ropes, or hand spliced terminations for three strand ropes. These terminations are designed to drastically reduce the stress put on the rope to minimize strength loss. They also typically include a protective thimble or abrasion resistant sleeve to further protect the rope at the stress points.



Factory Installed Connectors - Rope manufacturers can also include hardware connection options. Snaphooks with swivels are included on many lifelines to make attachment even easier.





TEUFELBERGER KM-III MAX STATIC ROPE

It is equipped with a core of polyamide and a cover of polyester. This polyester cover is robust and ideal for ascenders since it features a very good grip. Therefore, the climber is able to move up the rope without the bounce one usually encounters on an all-polyamide climbing rope. The polyester cover is perfectly balanced with the polyamide core to limit rotation, recoil and stretch. The rope construction of the KM III with its 32-strand cover provides for an optimum cover/core ratio ensuring an extraordinarily smooth cover, higher tensile strength values and excellent handling.

Key Features: NFPA 1983: Technical. EN 1891: Type A. ANSI Z133.

LENGTH	DIAMETER	STRENGTH	PART*	WHITE	COLOR†
300'	7/16" (11 mm)	MBS 8,465 lbs	C33_-14-00300	\$340.00	\$384.00
300'	1/2" (12.5 mm)	MBS 11,275 lbs	C33_-16-00300	\$395.00	\$449.00
600'	7/16" (11 mm)	MBS 8,465 lbs	C33_-14-00600	\$625.00	\$700.00
600'	1/2" (12.5 mm)	MBS 11,275 lbs	C33_-16-00600	\$744.00	\$859.00



PMI EXTREME PRO

An incredible rope from PMI, Extreme Pro with Unicore technology is the ultimate 11 mm polyester kernmantle rope. Unicore technology creates the ultimate bond between sheath and core that ensures sheath slippage is nearly zero, even when entirely cut circumferentially. If the sheath is cut, it will not slip down and bunch below the damaged area. See the illustration above. Most stock ropes include sewn eye (+\$28.00).

Key Features: Unicore technology • Nearly zero sheath slippage • 100% Polyester Sheath • 100% Nylon 6.6 Core • Sheath cannot bunch

LENGTH	DIAMETER	COLOR	STRENGTH	PART	PRICE
300'	7/16" (11 mm)	GWO	MBS 8,452 lbs	PR110E1092UC	\$317.60
300'	7/16" (11 mm)	CWO	MBS 8,452 lbs	PR110E2092UC	\$317.60
600'	7/16" (11 mm)	GWO	MBS 8,452 lbs	PR110E1183UC	\$635.30
600'	7/16" (11 mm)	CWO	MBS 8,452 lbs	PR110E2183UC	\$635.30



PMI CLASSIC PRO

PMI's Classic EZ-Bend 16-carrier construction combined with the toughest nylon on the market makes PMI ropes some of the toughest in the world. PMI Classic 16-carrier ropes will always beat 32, 40, and 48-carrier designs made with lesser quality nylons hands down in abrasion and real-world durability tests. Although all diameters of PMI Classic rope are 16-carrier sheath design, the denier (thickness) of each diameter's sheath is different. It is carefully designed to provide the maximum abrasion resistance, "grab" the core to minimize sheath slippage, and provide the desired hand for the intended applications.

Key Features: NFPA Certified • 16-carrier construction • CH1801 • Third party certified by UL (Underwriters Laboratories) • CE • Torsionally balanced, continuous filament nylon

LENGTH	DIAMETER	STRENGTH	PART*	WHITE	COLOR†
300'	7/16" (11 mm)	MBS 6,407 lbs	RR110_092E	\$283.20	\$340.00
300'	1/2" (12.5 mm)	MBS 9,442 lbs	RR125_092E	\$335.30	\$393.50
300'	5/8" (16 mm)	MBS 15,287 lbs	RR160_092E	\$419.10	\$488.10
600'	7/16" (11 mm)	MBS 6,407 lbs	RR110_183E	\$566.50	\$726.00
600'	1/2" (12.5 mm)	MBS 9,442 lbs	RR125_183E	\$670.60	\$787.10
600'	5/8" (16 mm)	MBS 15,287 lbs	RR160_183E	\$847.10	\$976.00
1,200'	7/16" (11 mm)	MBS 6,407 lbs	RR110_366E	\$1,137.80	\$1,360.00
1,200'	1/2" (12.5 mm)	MBS 9,442 lbs	RR125_366E	\$1,341.00	\$1,573.90
1,200'	5/8" (16 mm)	MBS 15,287 lbs	RR160_366E	\$1,694.20	\$1,952.00



GME SUPPLY CONTROLLED DESCENT KIT

Kit includes 300' 7/16" WestFall Pro PSK Rope, GME Supply Yellow Waterproof Rope Bag, Petzl I'D Small Self-Braking Rope Descender, Guardian Premium Cross Arm Strap, and (2) 7400 4-7/8" x 3" steel carabiners.

91100-300 300' rope - \$649.99

91100-600 600' rope - \$939.99

*To complete the part number, replace the () with the corresponding color code.

Not all rope diameters are available in all colors.

†Color patterns and tracer colors may vary slightly.

For custom lengths, please call us at (800) 940-6762 or e-mail info@gmesupply.com.



WESTFALL PRO PSK

GO TO WWW.GMESUPPLY.COM/ROPE TO VIEW ALL ROPE & RESCUE GEAR



WESTFALL PRO PSK

Westfall Pro PSK and 100% polyester rope, and is the ideal rope for use in rescue kits, vertical lifelines, and ascent/descent rope access work. Developed alongside the people that use static rope everyday to be the ultimate kernmantle rope. PSK is durable, extremely strong, and has very low stretch. The rope has extremely high resistance to abrasion thanks to the firm, smooth sheath.

Five different color options make it easy to identify rescue, lifelines, or work positioning lines. Alternatively users can color code their rope by length. PSK is available with or without sew eyes, however most stock ropes will have eyes included.

Key Features: • Maximum strength • Extremely low stretch • Firm, smooth sheath mitigates debris penetration, and increases durability • Multiuse - Perfect for rescue, vertical lifelines, and ascent/descent • Operates consistently in wet and dry conditions • Two sew eyes

Westfall Pro improved the PSK kernmantle rope by adding another eye. This extra eye allows the rope to be used from both sides, extending the lifetime of the rope at no additional cost. This will help technicians further mitigate debris penetration and ensure the rope performs consistently use after use.



LENGTH	DIAMETER	STRENGTH	PART*	WHITE	COLOR†
300'	7/16" (11 mm)	6,750 lbs	PSK110__092EYETWO	\$319.99	\$347.99
300'	1/2" (12.5 mm)	9,000 lbs	PSK125__092EYETWO	\$358.99	\$398.99
600'	7/16" (11 mm)	6,750 lbs	PSK110__183EYETWO	\$599.99	\$653.99
600'	1/2" (12.5 mm)	9,000 lbs	PSK125__183EYETWO	\$674.99	\$754.99
1,200'	7/16" (11 mm)	6,750 lbs	PSK110__366	\$1,182.99	\$1,281.99
1,200'	1/2" (12.5 mm)	9,000 lbs	PSK125__366	\$1,273.99	\$1,433.99

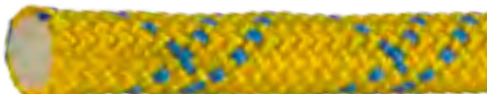

STERLING HTP STATIC

Sterling HTP static ropes have proven to be the most durable and best performing static ropes available. The benefits of using HTP include having a rope with better overall durability, higher strength, and extremely low stretch. With less stretch, the HTP is highly efficient rope for haul systems, rope bridges, and industrial rope access work. Sterling HTP ropes do not lose strength in wet conditions. Certified to NFPA 1983, 2012 edition. See the Unicore Technology illustration. Most stock ropes include sewn eye (+\$28.00).

Key Features: 100% polyester static • Significantly lower elongation is perfect for any haul system

LENGTH	DIAMETER	STRENGTH	PART*	WHITE	COLOR†
300'	7/16" (11 mm)	MBS 6,856 lbs	P110__0092	\$289.25	\$315.85
300'	1/2" (12.5 mm)	MBS 9,081 lbs	P130__0092	\$326.85	\$367.40
300'	5/8" (16 mm)	MBS 12,993 lbs	P160__0092	\$436.50	\$471.95
600'	7/16" (11 mm)	MBS 6,856 lbs	P110__0183	\$569.55	\$621.90
600'	1/2" (12.5 mm)	MBS 9,081 lbs	P130__0183	\$643.50	\$723.45
600'	5/8" (16 mm)	MBS 12,993 lbs	P160__0183	\$859.40	\$929.20
1,200'	7/16" (11 mm)	MBS 6,856 lbs	P110__0366	\$1,183.40	\$1,281.00
1,200'	1/2" (12.5 mm)	MBS 9,081 lbs	P130__0366	\$1,273.75	\$1,433.40
1,200'	5/8" (16 mm)	MBS 12,993 lbs	P160__0366	\$1,750.70	\$1,915.40



PELICAN STATIC MASTER

The first choice for strenuous use by arborists, fire and rescue professionals. Pelican's block creel static kernmantle construction features a tough chemical-resistant polyester cover over a nylon core, providing maximum energy absorption. Steam setting helps to eliminate cover over core slippage. The rope is firm yet flexible enough to be tied or passed over a pulley sheave. These ropes are resistant to most chemicals and have excellent retention in extreme conditions. U.L. Certified to NFPA 1983-2006 edition standards.

LENGTH	DIAMETER	STRENGTH	PART*	WHITE	COLOR†
300'	7/16" (11 mm)	ABS 7,047 lbs	2WP-14_-03S	\$225.00	\$270.00
300'	1/2" (13.5 mm)	ABS 9,807 lbs	2WP-16_-03S	\$365.00	\$360.00
300'	5/8" (16 mm)	ABS 11,182 lbs	2WP-20_-03S	\$435.00	\$490.00
600'	7/16" (11 mm)	ABS 7,047 lbs	2WP-14_-06S	\$450.00	\$475.00
600'	1/2" (13.5 mm)	ABS 9,807 lbs	2WP-16_-06S	\$660.00	\$730.00
600'	5/8" (16 mm)	ABS 11,182 lbs	2WP-20_-06S	\$800.00	\$790.00
1,200'	7/16" (11 mm)	ABS 7,047 lbs	2WP-14_-12S	\$725.00	\$1,350.00
1,200'	1/2" (13.5 mm)	ABS 9,807 lbs	2WP-16_-12S	\$1,315.00	\$1,315.00
1,200'	5/8" (16 mm)	ABS 11,182 lbs	2WP-20_-12S	\$1,575.00	\$1,775.00

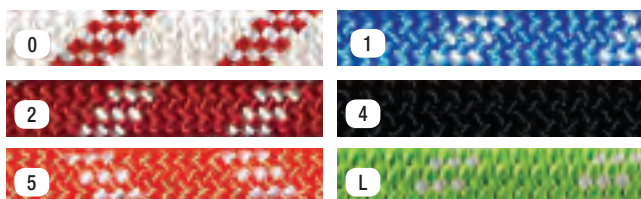

*To complete the part number, replace the () with the corresponding color code.
 †Not all rope diameters are available in all colors.
 ‡Color patterns and tracer colors may vary slightly.
 For custom lengths, please call us at (800) 940-6762 or e-mail info@gmesupply.com.



WESTFALL PRO 3-STRAND COMPOSITE VERTICAL LIFELINE

Constructed of a 5/8" 3-strand polyester rope, and double locking safety snap hook. Lightweight, abrasion resistant, low stretch, and energy absorbent. 420 lbs capacity, 5,600 lbs MBS, and ANSI compliant.



LENGTH	END CONNECTOR	END CONNECTOR	PART	PRICE
300'	Eye	Eye	5800-300	\$210.99
600'	Eye	Eye	5800-600	\$420.99
1200'	Eye	Eye	5800-1200	\$540.99
25'	Snaphook	Eye	5805-025	\$54.99
50'	Snaphook	Eye	5805-050	\$68.99
75'	Snaphook	Eye	5805-075	\$83.99
100'	Snaphook	Eye	5805-100	\$97.99
200'	Snaphook	Eye	5805-200	\$155.99
300'	Snaphook	Eye	5805-300	\$213.99
400'	Snaphook	Eye	5805-400	\$271.99
600'	Snaphook	Eye	5805-600	\$387.99
25'	Snaphook	Snaphook	5810-025	\$90.99
50'	Snaphook	Snaphook	5810-050	\$105.99
75'	Snaphook	Snaphook	5810-075	\$119.99
100'	Snaphook	Snaphook	5810-100	\$134.99
200'	Snaphook	Snaphook	5810-200	\$192.99
300'	Snaphook	Snaphook	5810-300	\$259.99
400'	Snaphook	Snaphook	5810-400	\$308.99
600'	Snaphook	Snaphook	5810-600	\$479.99



5805



5810



GUARDIAN 50' POLY STEEL LIFELINE WITH SHOCK PACK

5/8" poly steel rope is ideal for high-moisture environments; resists cuts and abrasion; available with a shock absorber, positioning device, 18 inch extension lanyard, and 2 double-locking snaphooks; ANSI compliant.

01320 50' - \$224.99



GME SUPPLY BASIC LIFELINE KIT

Kit includes WestFall Pro 3-Strand Composite Vertical Lifeline, WestFall Pro Rope Grab Assembly, GME Supply Black Waterproof Rope Bag, Guardian Premium Cross Arm Strap.

91000-300 300' Rope - \$424.99

91000-600 600' Rope - \$734.99



GME SUPPLY PREMIUM LIFELINE KIT

Kit includes 7/16" WestFall Pro PSK Rope, Petzl ASAP Mobile Rope Grab, Petzl ASAP Sorber Axess, GME Supply Yellow Waterproof Rope Bag, Guardian Premium Cross Arm Strap, and (2) WestFall Pro 07405 4-1/2" x 2-3/4" steel carabiners.

91050-300 300' Rope - \$774.99

91050-600 600' Rope - \$1,064.99





H2O **QUICK SHIP** **VIDEO** **KITS SAVE CASH**

GEAR EXPERTS®

“ In 2014 we were tasked with designing a rescue component storage solution that was large enough to fit a complete kit, convenient to transport, water resistant and offered peace of mind. This bag has proven to be the premier rescue kit solution for the past 4 years. The transparent front pocket allows you to easily view instructions or component lists. The bag can be locked out to ensure components don't go walking off or “borrowed” for by your coworkers for other jobs. We even have multiple contrasting color options, which mean you can color coordinate your bags to the task at hand. The backpack straps make it easy to go from truck to tower and the lock out feature ensures you're only making one trip. ”



JIM ZEPP
Southern Regional Sales Manager

GME SUPPLY PREMIUM ROPE BAG

32.5" H, 9" W. Easy fold lid to cover zipper from exposure to the elements. Comfortable backpack straps. Easy access side carry handle. Straps that overlap at the top to allow easy hardware connection for hoisting. Large transparent front pocket for instructions and contents. Offers not only space, but a gusseted bottom to maintain shape. Grommet at base of bag to drain moisture. Sewn-in web reinforcement from back to front. Exclusive GME Supply "Climb Higher" logo.

5600RB Orange - \$87.99

5605RB Black - \$87.99

5610RB Yellow - \$87.99

ROPEBAGKIT All 3 bags - \$253.97



PETZL ROPE BAG

Bag remains upright and has an exterior folding lid system that allows easy access to the contents of the bag. External zippered pocket. Transparent external window. (2) carrying handles with adjustable strap. Small: 25 liters, 15" H, 11" W. Large: 35 liters, 20" H, 11" W.

S41AY 025 Yellow, S - \$59.95

S41AY 035 Yellow, L - \$69.95

S41AR 025 Red, S - \$59.95

S41AR 035 Red, L - \$69.95



S L

HOW MUCH BAG DO YOU NEED?

ITEM	PART #	10 MM OR 3/8"	11 MM OR 7/16"	12.5 MM OR 1/2"	16 MM OR 5/8"
Sterling Rope Bag - S	MDBAGROPES09	60 m or 200'	45 m or 150'	35 m or 115'	28 m or 94'
Sterling Rope Bag - M	MDBAGROPEM07	105 m or 347'	79 m or 260'	60 m or 200'	50 m or 163'
PMI Standard Rope Bag - S	RB44015	120 m or 393'	100 m or 328'	75 m or 246'	61 m or 200'
PMI Deluxe Rope Bag - L	RB4400_	160 m or 524'	120 m or 393'	92 m or 301'	75 m or 246'
PMI Rope Bag - L	RB44021	160 m or 524'	120 m or 393'	92 m or 301'	75 m or 246'
Sterling Rope Bag - L	MDBAGROPEL08	212 m or 696'	159 m or 522'	121 m or 400'	100 m or 326'
DBI Sala Rope Bag - L	8700223	250 m or 820'	200 m or 656'	100 m or 328'	80 m or 262'
PMI Rope Bag - XL	RB44024	250 m or 820'	200 m or 656'	100 m or 328'	80 m or 262'
GME Supply Premium Rope Bag - L	56_RB	250 m or 820'	200 m or 656'	100 m or 328'	80 m or 262'
Elk River Eze-Man Rope Bag - S	84302	259 m or 850'	212 m or 700'	106 m or 350'	85 m or 279'
Petzl Rope Bag - S	S41A_025	280 m or 918'	220 m or 721'	185 m or 606'	148 m or 485'
PMI Rope Bag - 2XL	RB44056	285 m or 935'	230 m or 754'	200 m or 656'	160 m or 524'
Elk River Eze-Man Rope Bag - M	84303	342 m or 1,125'	274 m or 900'	137 m or 450'	110 m or 360'
Petzl Rope Bag - L	S41A_035	400 m or 1,312'	310 m or 1,017'	260 m or 853'	208 m or 682'
Elk River Eze-Man Rope Bag - L	84304	419 m or 1,375'	335 m or 1,100'	167 m or 550'	133 m or 436'





STERLING ROPE BAG

Sterling's rope bags are available in three sizes and feature padded backpack straps for easy hauling. A clear front pocket to store a rope log, and a rope cinch closure.

MDBAGROPES09 S, yellow (19" H, 10" W) - \$35.85

MDBAGROPEM07 M, orange (22" H, 17" W) - \$40.50

MDBAGROPEL08 L, red (25" H, 11" W) - \$46.85



PMI ROPE BAG

Double sewn seams. 1000 D heavy coated Cordura, drawstring closure. 1" tubular handles with rope insert. 5/8" grommet on the side of the bag. Outside pocket. Padded backpack straps. Internal clip-in loop at bottom of bag. All sizes available in red, blue, black, and orange.

RB44015 Standard (21.5" H, 10.5" W) - \$39.99

RB44021 L (25" H, 10.5" W) - \$54.99

RB44024 XL (23" H, 16" W) - \$59.99

RB44056 2XL (28.5" H, 17" W) - \$62.99



ELK RIVER EZE-MAN ROPE BAG

Made from black heavy-duty polyester. (1) inside and (1) outside rope attachments. Drawstring top with side handles.

84302 S (12" H, 12" W) - \$55.34

84303 M (16" H, 12" W) - \$55.70

84304 L (20" H, 12" W) - \$55.84



HUSKY ROLLING TOOL BOX UTILITY CART

50 Gal. holding capacity, great for storing large power tools, accessories and gear. Heavy duty removable tool tray is extra-large and great for storing multiple sized hand tools. 37" work cart comes with extra-large metal latches and a built-in keyed lock system, keeping all your gear secure on the jobsite.

209261 (19" H, 18" W, 34" L) - \$74.99



CARLISLE PLASTIC TRASH CAN - 44 GALLON

Trashcan is tough built, food-safe and easy to carry. Made of durable plastic with reinforced drag skids. The comfort curve handles allow for easy carrying. NSF2 Certified.

34104423 - \$40.99





**DBI SALA
LAD-SAF ROPE GRAB**

5/8" (16 mm) rope diameter. Mobile design automatically follows user for hands-free operation, detachable design can be attached or removed anywhere along lifeline, inertia and cam-locking systems for safety and "panic-grab" prevention, for use on polyester/ polypropylene rope lifeline.

5000335 - \$159.99
5002045 With 1242007
EZ-Stop lanyard - \$240.99



**ELK RIVER ROPE
GRAB WITH
ATTACHED ZORBER**

5/8" (16 mm) rope diameter. Attached Zorber web lanyard, moves up and down the length of vertical rope lifelines providing continuous fall protection.

19273 - \$111.71

**WESTFALL PRO
DELUXE ROPE GRAB
WITH LANYARD**

5/8" (16 mm) rope diameter. Deluxe self-tracking/park rope grab. 2' Shock absorbing lanyard. Self-tracking design provides ease of vertical movement. Hinged body allows simple placement at any point along rope. Locks onto the rope lifeline at the onset of a fall event.

60612 - \$214.99



5002045



**GUARDIAN ROPE GRAB
WITH LANYARD**

5/8" (16 mm) rope diameter. Removable rope grab. Easy to install. Locks automatically when a fall occurs. Made of galvanized steel. Includes attached 3' shock absorbing lanyard. Minimum breaking strength 5,000 lbs.

01503 With attached 3' shock absorbing lanyard - \$99.99
01508 No extension - \$74.99

**WESTFALL PRO
TRAILING ROPE GRAB
WITH LANYARD**

5/8" (16 mm) rope diameter. Designed for 3-strand rope. Rope grab with 2" ring. Anti-panic lock for added safety. Anti-inversion plate for proper installation on rope. Includes 3' shock absorbing lanyard. ANSI compliant.

60601 Rope grab with lanyard - \$84.95
6050 Rope grab only - \$78.95

**FALLTECH ROPE
GRAB LANYARD SET**

5/8" (16 mm) rope diameter. Hinged design allows for easy attachment to the lifeline while the triple function lock provides the highest degree of safety and security available. Manual park feature allows grab to function in self-tracking or park mode. ANSI compliant.

8355 - \$277.99

**FALLTECH ROPE
GRAB LANYARD SET**

5/8" (16 mm) rope diameter. Hinged self-tracking rope grab, 3' shock absorbing lanyard. Self-tracking design provides ease of vertical movement. Hinged body allows simple placement at any point along rope. Locks onto the rope lifeline at the onset of a fall event.

8358 - \$109.99

**ELK RIVER DUAL
SIZE TRAILING
ROPE GRAB**

5/8" & 3/4" (16 & 19 mm) rope diameter. Designed to easily move up and down the length of vertical rope lifelines providing continuous fall protection. 2" Ring.

19250 - \$50.22





PETZL ASAP MOBILE FALL ARRESTER

3/8" - 7/16" (10 - 12 mm) rope diameter. Arrests falls, slides, and uncontrolled descents. Works on vertical or angled rope. Locks on the rope even if grabbed during the fall. Moves up or down the rope without any manual manipulation of the device. Easy to install and remove at any point on the rope. Weight capacities: 220 lbs without energy absorber, 308 lbs with ASAP Sorber, 551 lbs with Absorbica. ANSI Z359.15 compliant when used with Oxan Triact-Lock Carabiners, an ASAP Sorber or ASAP Sorber Axess, Captiv positioning bars, and a Ray 12 mm rope with a sewn termination.

B070AA00 w/o Carabiner - \$214.95

M72A TLA Carabiner - \$24.95



PETZL ASAP LOCK MOBILE FALL ARRESTER

3/8" - 1/2" (10 - 13 mm) rope diameter. Integrated locking function allows the user to immobilize the device to reduce the length of a fall. Arrests falls, slides, and uncontrolled descents. Works on vertical or angled rope. Moves up or down the rope without any manual manipulation. Easy to install and remove at any point on the rope. Connection arm makes the system loss-resistant when passing intermediate anchors. Weight capacities: 308 lbs with ASAP Sorber, 551 lbs with Absorbica. ANSI Z359.15 compliant when used with an ASAP Sorber or ASAP Sorber Axess, an Oxan Triact-Lock Carabiner, Captiv positioning bars, and a Ray 12 mm rope with a sewn termination.

B071BA00 - \$289.95



NEW

PETZL RAY ROPE

12 mm rope diameter. This rope has low stretch when put under tension. The sewn termination with protective sheath helps keep the connector in position and facilitates handling. ANSI Z359.15 compliant when used with an ASAP or ASAP Lock mobile fall arrester.

R091AA00 25' - \$45.95

R091AA01 50' - \$71.95

R091AA02 75' - \$97.95

R091AA03 100' - \$123.95

R091AA04 200' - \$227.95



NEW

PETZL CAPTIV

The Captiv positioning bar works as a makeshift captive eye- helping load the carabiner along its major axis, limit flipping, and keep an integrated connection to a device or lanyard. Compatible with Ok, Am'D, William, Oxan carabiners and the Rollclip A pulley carabiner.

M093AA00 - \$21.95



PETZL ASAP'SORBER LANYARD WITH ENERGY ABSORBER

Connects the ASAP or ASAP Lock mobile fall arrester to the harness. Allows the user to distance themselves from the rope in order to declutter the work area and protect the rope. Absorbs the energy of a fall by the tearing of specific stitching. Available in (2) lengths for a choice of the best balance between distance from the rope and reducing the fall length. 310 lbs weight capacity. Lacks sufficient energy absorption to safely arrest the potential energy during a two-person rescue. ANSI Z359.13 compliant 6' when used with Oxan Triact-Lock Carabiners and Captiv positioning bars.

L071BA00 20 cm - \$49.95

L071BA01 40 cm - \$54.95

NEW



PETZL ASAP'SORBER AXESS ENERGY ABSORBER

Connects to the ASAP or ASAP Lock mobile fall arrester to allow the user to work at a distance from the rope, in order to protect it during certain work phases. Equipped with tear-webbing inside a pouch that opens on each end, the absorber is protected from abrasion while allowing for regular inspection. In can be used in two-person rescue situations for a maximum load of 250 kg. ANSI Z359.13 compliant 6 feet when used with Oxan Triact-Lock Carabiners and Captiv positioning bars.

L071CA00 - \$55.95



KONG 802 BACK-UP MOBILE FALL ARRESTER

3/8" - 7/16" (10 - 12 mm) rope diameter. Works on vertical or angled rope. Moves up or down along the rope without manual intervention. Easy to install and remove at any point on the rope. For rope access applications unit can be used with tug cord. Non-aggressive cam design. One person weight capacity: 220 lbs. ANSI rated.

ANSI-8021N0400KK

Twistlock - \$166.24

ANSI-8022N0402KK

Autoblock - \$155.15

TUF-TUG ALUMINUM KERNMANTLE ROPE GRAB

1/2" - 5/8" (13 - 16 mm) rope diameter. Dual cams for double safety. Patented design pivots open for easy attachment anywhere on lifeline. Automatically travels up with user on pre-tensioned lifeline. Incorporates spring-loaded cams to hold rope grab in parked position.

5000-IE-AL-KM - \$89.99



MIO ROPE GRAB

1/2" (13 mm) rope diameter. Stainless steel self-trailing rope grab. Removable dual action pin for easy placement. Grips automatically in the event of a fall and dissipates the energy of the fall by slipping along the rope. Comes with lanyard and ANSI snaphook.

HD26005 1/2" rope - \$189.99

HD26006 5/8" rope - \$189.99

HD26114 7/16" rope - \$189.99



PETZL ASCENSION HANDHELD ROPE CLAMP

5/16" - 1/2" (8 - 13 mm) rope diameter. Designed for ascending and occasionally for hauling (progress capture); wide, ergonomic molded handle allows a comfortable yet powerful grip; lower holes for connecting a lanyard and installing a footape foot loop with a quick link, toothed cam with self-cleaning slot optimizes performance under any conditions, upper hole through which a carabiner attaches the device to the rope, 308 lbs weight capacity.

B17ALA Left handed, yellow - \$89.95

B17ALN Left handed, black - \$99.95

B17ARA Right handed, yellow - \$89.95

B17ARN Right handed, black - \$99.95

PETZL FOOTAPE ADJUSTABLE FOOT SLING

Attaches to the Ascension handheld ascender for rope ascents; underfoot strap is abrasion-resistant and is slightly rigid to make it easier to step into; adjustable elastic keeps the foot in the foot loop with any type of shoe; mini DoubleBack buckle easily and quickly adjusts length of foot loop.

C47A - \$34.95



WESTFALL PRO CHEST ASCENDER

3/8" - 1/2" (9 - 13 mm) rope diameter.

Compact and lightweight. Cam is spring-loaded and fitted with a catch mechanism. Easy for one-handed operation. Increased grip at low load, even on wet, greasy, oily ropes. Cam made from stainless steel for greater durability.

60400 - \$41.99



SKYLOTEC RINGO MINI ROPE ASCENDER

5/16" - 1/2" (8 - 13 mm) rope diameter.

0.71" W, 1.57" L, 2.76" H. This unique ascender device is a perfect aid for rope ascent and pulling of rope. It is placed like a ring on the middle finger and provides extra grip and strength during dragging and hauling operations, for highest efficiency.

H-205 - \$74.99



PETZL TIBLOC ROPE CLAMP

5/16" - 7/16" (8 - 11 mm) rope diameter.

Extremely compact and lightweight. Great for rope access or rescue workers. Easy to use with a locking carabiner for ascending ropes or for setting up hauling systems. Teeth and a self-cleaning slot optimize performance under any conditions. Attachment hole for keeper cord.

B01BN Ultralight ascender, black - \$49.95

B01B Ultralight ascender, orange - \$44.95



PETZL CROLL CHEST ROPE CLAMP

Compact, lightweight chest rope clamp. Used with the Ascension handled rope clamp. Toothed cam with self-cleaning slot optimizes performance under any condition. Stainless steel cam has better resistance to corrosion. 308 lbs weight capacity.

B16BAA Small, 8 - 11 mm rope diameter - \$74.95

B016AA00 Large, 8 - 13 mm rope diameter - \$74.95



PETZL RESCUCENDER CAM-LOADED ROPE CLAMP

3/8" - 1/2" (9 - 13 mm) diameter rope.

Simple to use and ergonomic, the Rescucender is an openable cam-loaded rope clamp designed for use in haul systems as a tractor or progress capture device. 308 lbs weight capacity.

B50A - \$99.95



KONG LIFT RIGHT HANDED ASCENDER

5/16" - 1/2" (8 - 13 mm) rope diameter.

Excellent ability to block out due to the holes on the cam and on the side plate. Great wear resistance and a reduction of the fragility that usually penalizes steels by quenching to low temperatures. Opening lever is ergonomic, easy to handle, and reduces risk of accidental opening.

896R04D00KK Right handed, red - \$63.92

896B04S00KK Left handed, blue - \$63.92



KONG DUCK ROPE CLAMP

5/16" - 1/2" (8 - 13 mm) rope diameter.

First and only belay device that works also on plain and tubular slings from 10 mm - 15 mm. Due to the small dimensions, it can be easily inserted even with one hand. The big hole allows the rotation of sleeve connectors. Use as an emergency rope clamp during self belay, retrievals, progression maneuvers and regulating daisy chains. 220 lbs weight capacity.

888 - \$84.99



COMPLETE YOUR RESCUE KIT

ANCHORAGE	45
HARDWARE	49
KERNMANTLE ROPE	56
ROPE BAG	59
ASCENDERS	62
DESCENDERS	64
HAUL KITS	73



PETZL MAESTRO

Designed to assist in a rescue operation. Makes manipulation of heavy loads easier and can be used in a primary or back-up belay. Shift from lowering to hauling is immediate which can save you seconds when rescuing operations are underway. Large integrated progress-capture pulley mounted on sealed ball bearing ensures excellent efficiency. AUTO-LOCK system will automatically lock the rope in position when the handle is not in use.

D024AA00 Yellow S - \$549.95

D024BA00 Red L - \$549.95



WESTFALL PRO WORK RESCUE DESCENDER

7/16" (11 mm) rope diameter. Unique innovative cam action for precise control. 529 lbs working load limit suitable for a two-man rescue. Panic brake. 22 kN MBS. ANSI Z359.4 compliant.

60504 D4, 7/16" (11 mm) rope diameter - \$249.99

60505 D5, 1/2" (13 mm) rope diameter - \$249.99



PETZL I'D DESCENDER

7/16" (10 - 11.5 mm) rope diameter. Large handle is rotated in various orientations to control whether the unit is in descent, stopped, or complete lock-off. Also available in Black. ANSI Z359.4 compliant.

D020AA00 Small, Yellow, 7/16" (10 - 11.5 mm) rope diameter - \$299.95

D020BA00 Large, Red, 1/2" (12.5 - 13 mm) rope diameter - \$299.95



SKYLOTEC SIRIUS

7/16" (11 mm) rope diameter. Auto-returning operating lever has a particularly small radius of motion so that you can work fast, accurately, more comfortably and safely. Developed for extended use under the toughest of conditions. Outstanding handling thanks to compact design and intuitive route of the rope. Made of up to 100% metal.

A-050 - \$275.00



PETZL I'D EVAC SELF-BRAKING DESCENDER

7/16" (10 - 11.5 mm) rope diameter. Self-braking descender is primarily designed for lowering from an anchor. Ergonomic handle is specifically oriented for managing a load from the anchor and offers comfortable descent control. ANSI Z359.4 compliant.

D020CA00 Yellow - \$319.95

D020CA01 Black - \$339.95



DBI SALA NOWORRIES DESCENDER

Incorporates the functionality of a stop descender, chest ascender, and belay device in one compact unit, allows user to hard lock, ANSI Z359.4 compliant.

8700387 7/16" - \$269.99

8700388 1/2" - \$269.99



DBI SALA FISK DESCENDER

1/2" (13 mm) rope diameter. Descent control system designed for durability, thermal capacity and smooth flow, allows the operator to tie off and position themselves at a specific work level.

2103189 - \$276.99





PETZL KOOTENAY KNOT-PASSING PULLEY

3/4" (19 mm) maximum rope diameter, 3" (76 mm) sheave diameter. Voluminous rope channel allows the passage of joining knots, large diameter sheave mounted on sealed ball bearings for excellent efficiency, locking pins on the sheave allow use of the pulley as an anchor.

P67 - \$199.95



MBS
40 kN



MBS
16 kN

PETZL JAG TRAXION

5/16" - 7/16" (8 - 11 mm) rope diameter, 1" (25 mm) sheave diameter. Double progress capture pulley designed for use with the JAG double pulley to make a 4:1 haul system. Sheaves mounted on sealed ball bearings for excellent efficiency.

P54 - \$139.95



MBS
22 kN

PETZL PRO TRAXION

5/16" - 1/2" (8 - 13 mm) rope diameter, 1.5" (38 mm) sheave diameter. Integrated progress capture device can be used as a pulley or rope clamp, lockable moving side plate for easy rope installation.

P51A - \$149.95



MBS
22 kN

PETZL JAG PULLEY

5/16" - 7/16" (8 - 11 mm) rope diameter, 1" (25 mm) sheave diameter. Double pulley designed for use with the Jag Traxion double progress capture pulley to make a 4:1 haul system; sheaves mounted on sealed ball bearings.

P45 - \$89.95



MBS
15 kN

PETZL MICRO TRAXION

5/16" - 7/16" (8 - 11 mm) rope diameter, 1" (25 mm) sheave diameter. Ultra-light, ultra-compact progress-capture pulley that is exceptionally efficient (91%) thanks to its sealed ball bearings; can be used as a simple pulley.

P53 - \$129.95



MBS
5 kN

PETZL FIXE PULLEY

9/32" - 1/2" (7 - 13 mm) rope diameter, 0.8" (21 mm) sheave diameter. Fixed side plates that allow for quick installation and coupling with a rope clamp; lightweight and compact.

P05W Yellow - \$24.95
P05WN Black - \$26.95



MBS
20 kN

PETZL ROLLCLIP Z PULLEY CARABINER

9/32" - 1/2" (7 - 13 mm) rope diameter, 0.7" (18 mm) sheave diameter.

P75 TL Triact-lock - \$49.95
P75 SL Screw-lock - \$44.95



MBS
20 kN

PETZL ROLLCLIP PULLEY CARABINER

9/32" - 1/2" (7 - 13 mm) rope diameter, 0.7" (18 mm) sheave diameter.

P74 TL - \$49.95



MBS
5 kN

PETZL MOBILE PULLEY

9/32" - 1/2" (7 - 13 mm) maximum rope diameter, 0.8" (21 mm) sheave diameter. Lightweight, compact pulley, designed for hauling systems and deviations, sheave mounted on self-lubricating bushings for efficiency.

P03A - \$24.95



MBS
23 kN

PETZL GEMINI PULLEY

9/32" - 7/16" (7 - 11 mm) rope diameter, 1" (25 mm) sheave diameter. Special side plates designed for use with a prusik friction hitch in progress capture systems, Parallel mounted sheaves and auxiliary attachment point.

P66A - \$89.95



MBS
36 kN

PETZL TWIN PULLEY

9/32" - 1/2" (7 - 13 mm) rope diameter, 2" (51 mm) sheave diameter. High strength, high efficiency double prusik pulley, special side plates for use with a prusik friction hitch in progress capture systems.

P65A - \$119.95



MBS
35 kN

PETZL MINDER PULLEY

9/32" - 1/2" (7 - 13 mm) maximum rope diameter, 2" (51 mm) sheave diameter. Designed for pulley systems or hauling heavy loads. Special side plates designed for use with a prusik friction hitch in progress capture systems.

P60A - \$69.95



MBS
36 kN

PETZL RESCUE PULLEY

9/32" - 1/2" (7 - 13 mm) maximum rope diameter, 1.5" (38 mm) sheave diameter. Designed for pulley systems or hauling heavy loads. Special side plates designed for use with a prusik friction hitch in progress capture systems.

P50A - \$59.95



Rock Exotica's Omni-Blocks combine a smooth swivel with an extremely efficient pulley into one piece of hardware. This allows the entire rigging system to be more compact. The unique side plate on the pulley allows for rope to be installed and removed without removing the Omni-Block from the anchor. They're available in single and double sheave versions from 1.1" up to 2.6" and are made in the USA.



GEAR EXPERTS®

“ Like any 28 year old company, Rock Exotica has seen its share of change throughout the years. One thing that hasn't changed is their steadfast desire to produce the most innovative technical equipment available while managing the entire manufacturing process themselves in Clearfield, Utah. You'll see Rock Exotica products scattered throughout our catalog because true innovation isn't tied down to a single category. ”



AUSTIN PAINTER
Great Lakes Regional Sales Manager



MBS
23 kN

ROCK EXOTICA OMNI-BLOCK 1.1" SWIVEL PULLEY

1/2" (13 mm) maximum rope diameter, 1.1" (28 mm) sheave diameter. Combines pulley with a swivel; replaces conventional pulley, carabiner and swivel.

P54 Orange - \$85.00

P54-B Black - \$86.00



MBS
36 kN



ROCK EXOTICA OMNI-BLOCK 1.5" SWIVEL PULLEY

1/2" (13 mm) maximum rope diameter, 1.5" (38 mm) sheave diameter. Can replace a conventional pulley, carabiner, and swivel and is lighter, less expensive and saves valuable vertical space, allows installing/removing the rope while the pulley is still anchored.

P51 Orange - \$94.00

P51-B Black - \$96.00



MBS
34 kN

SMC ADVANCE TECH HX DOUBLE PULLEY

9/32" - 1/2" (7 -12.5 mm) rope diameter, 1.5" (38 mm) sheave diameter. Integrated cam for progress capture without the need of prusiks, one-handed operation.

SM154900N - \$145.99

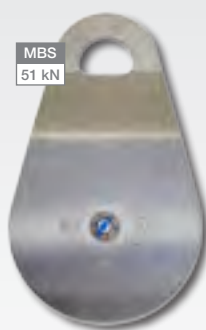

MBS
51 kN

SMC 4" STAINLESS STEEL PULLEY

5/8" (16 mm) maximum rope diameter, 4" (102 mm) sheave diameter. Matched double-bend side plates help eliminate compression under load.

SM152500 - \$129.99



MBS
22 kN

SMC CRX PULLEY

1/2" (13 mm) maximum rope diameter, 1.25" (32 mm) sheave diameter. Smooth running nylon sheave on a stainless steel rivet axle. Compact size.

157303 - \$15.99



MBS
34 kN

SMC ADV TECH MATE DOUBLE PULLEY

9/32" - 1/2" (7 -12.5 mm) rope diameter, 1.5" (38 mm) sheave diameter. Made from high quality aluminum. Anodized to help prevent corrosion.

SM154801N - \$80.99



MBS
22 kN



BLUEWATER ROPES MICRO PULLEY

5/16" - 1/2" (8 -13 mm) maximum rope diameter, 1.25" (32 mm) sheave diameter. Lightweight design features a steel axle. Anodized aluminum frame and sheave.

610116 Black - \$12.95

610117 Orange - \$12.95





ROCK EXOTICA OMNI-BLOCK 2.0" SWIVEL PULLEY

1/2" (13 mm) maximum rope diameter, 2" (51 mm) sheave diameter. Can replace a conventional pulley, carabiner, and swivel and is lighter, less expensive and saves valuable vertical space, allows installing/removing the rope while the pulley is still anchored.

P53 Orange - \$118.00

P53-B Black - \$119.00



ROCK EXOTICA OMNI-BLOCK 2.0" DOUBLE SWIVEL PULLEY

1/2" (13 mm) maximum rope diameter, 2" (51 mm) sheave diameter. Install and remove rope while still connected to the anchor; side plate locks with two-stage, double-catch safety mechanism; integrated swivel allows pulley to orient while reducing gain; connect, install and remove rope with one hand; CNC machined for optimal weight and strength.

P53D Orange - \$172.00

P53D-B Black - \$174.00



ROCK EXOTICA OMNI-BLOCK 2.6" SWIVEL PULLEY

1/2" (13 mm) maximum rope diameter, 2.6" (66 mm) sheave diameter. The Omni 2.6" brings heavy duty rigging to the Omni family with an MBS of 80 kN and WLL of 20 kN. Features a prusik minding side plate, and push-button access to install rope. For material handling see pages 103-104.

P55 Orange - \$188.00



ROCK EXOTICA MACHINED MINI 1.1" DOUBLE PULLEY

7/16" (11 mm) maximum rope diameter, 1.1" (28 mm) sheave diameter. Milled from T6 aluminum for optimal strength.

P21D Standard color - \$87.50

P21D-B Black - \$88.50



ROCK EXOTICA MACHINED RESCUE 1.5" DOUBLE PULLEY

1/2" (13 mm) maximum rope diameter, 1.5" (38 mm) sheave diameter. Integrated axle adds to strength. Slim profile.

P22D Standard color - \$101.00



ROCK EXOTICA MACHINED RESCUE 1.5" PULLEY

1/2" (13 mm) maximum rope diameter, 1.5" (38 mm) sheave diameter. Lightweight pulley with low resistance bearing.

P22 Standard color - \$55.00

P22-B Black - \$67.00



ROCK EXOTICA 2.0" PRUSIK MINDING PULLEY

1/2" (13 mm) maximum rope diameter, 2" (51 mm) sheave diameter. Milled from solid 7075 aluminum.

P1 Standard color - \$64.00

P1-B Black - \$64.00



ROCK EXOTICA 2.0" DOUBLE PRUSIK MINDING PULLEY

1/2" (13 mm) maximum rope diameter, 2" (32 mm) sheave diameter. Milled from solid 7075 aluminum.

P1D Standard color - \$113.00



DBI SALA MECHANICAL ROPE PROTECTOR

Designed for simple, man made edges and complex natural edges. Multiple rigging points. Multiple units can be connected to extend the protected area. Constructed of four independent modules that can be positioned to adapt to the terrain. Vertical and horizontal rollers guide the moving rope to provide protection at all angles.

8700302 - \$344.99



MSA SURETYMAN TERMINATION PLATE

For use with 5/8" three strand, double-braid, or kernmantle rope; provides a quick reusable field termination that eliminates the need for knots.

SRIW1000 - \$59.99



WESTFALL TERMINATION PLATE

Used to connect a rope to something without the use of knots or factory terminations; for use with kernmantle rope between 7/16" and 3/4" or three strand rope between 5/8" and 3/4", ANSI compliant.

7001 - \$50.99



PETZL CATERPILLAR

Vertical and horizontal rollers guide the moving rope with a minimum of rubbing. Each module can be positioned independently to adapt to the terrain, includes 4 modules and 6 quick links.

P68 - \$159.95



PMI EDGE ROLLER SYSTEM

3 linked units with hard anodized aluminum side plates and two roller bars each. Can be used linked together with the furnished screw links at sharp edges, or separated for long gradual breakovers; 4" wide aluminum rollers and holes for permanent mounting.

HD26086 - \$225.00



ROCK EXOTICA TRIRIG

Lightest high performance (3) hole plate; milled from oversize material so that all surfaces are machined, even the faces.

RP1 - \$27.00



ROCK EXOTICA PENTAPLATE

Made of strong aerospace aluminum alloy, (5) hole plate; thin design has the benefit of fitting carabiners and links better with less possibility of binding.

RP2 - \$49.00



PETZL PAW

19 mm holes allow the locking sleeves of most carabiners to pass through.

P63 M (5) Anchor point holes - \$54.95

P63 S (3) Anchor point holes - \$29.95



ROCK EXOTICA BOLT

Uses a quick detachable stainless steel rod, or 'bolt', allowing you to connect your gear directly to the five connection points without using carabiners.

RP5 - \$120.00



PMI ROPE ID MARKERS BOOK

Write, type, or stamp information on white area. The clear self-lamination portion wraps around to protect writing. Made of vinyl. Includes 6 tags per sheet, 10 sheets per book.

RC48001 - \$39.99



PMI ROPE ID KIT

Protect rope ends and provide important information such as when a rope is put into service, ID, etc. Write your own information on the ID tags and slip between shrink tube and rope. Marks any rope (RC48007 3/8" kit only). Kit includes 6 tags and 12 inches of 3/4" shrink tube.

RC48030 - \$6.99



PMI WHIP END DIP

Seal your rope ends to prevent fraying and add a color coding option to your gear with this water based liquid vinyl compound sealant. Non-toxic and easy to apply. 1 bottle = 64 ends with 3 coats each. Available in three colors: clear, red, and white.

RC48011 Clear - \$10.50

RC48012 Red - \$10.50

RC48013 White - \$10.50



STERLING MIL-SPEC WEBBING

The standard in 1" webbing, Mil-Spec tubular webbing is favored by climbers and rescue specialists for slings and anchor systems as it offers exceptional abrasion resistance. As its name implies, Mil-Spec is also the standard webbing for military applications.

LENGTH	WIDTH	STRAIGHT PULL	SEWN LOOP	PART*	PRICE
300'	1"	MBS 4,000 lbs	MBS 6,129 lbs	WB254MS_091	\$119.75

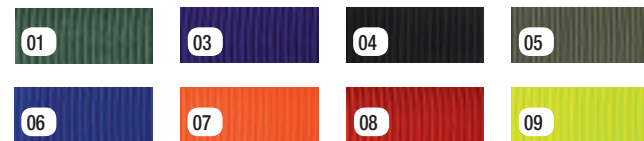

STERLING ROPE WICKED GOOD ROPE WASH

This product is chemical free and will not break down any of the fibers in your rope. Keep your rope clean so that it will last longer. Rope should be washed approximately after 30-40 uses. Each packet has enough soap for one wash and can be used to wash your rope by hand, washing machine, or in a tub of water.

MDWASH11 1 packet - \$2.40

MDWASH20 20 packets - \$39.95



STERLING 6 MM PRUSIK CORD

LENGTH	DIAMETER	COLOR	STRENGTH	PART	PRICE
44"	6 mm	Yellow	MBS 2,810 lbs	SC060NYTR044	\$11.50
9.5"	6 mm	Orange	MBS 2,810 lbs	SC060NYRTL09	\$9.25
9.5"	6 mm	Blue	MBS 2,810 lbs	SC060NYRTD09	\$9.25



STERLING 8 MM PRUSIK CORD

LENGTH	DIAMETER	COLOR	STRENGTH	PART	PRICE
16"	8 mm	Orange	MBS 4,496 lbs	SC080320716	\$12.00
16"	8 mm	Red	MBS 4,496 lbs	SC080320816	\$12.00
22"	8 mm	Blue	MBS 4,496 lbs	SC080320622	\$12.25

PMI ELECTRIC HOT KNIFE & ROPE CUTTER

This electric rope cutter hot knife may be used to cut rope and braided sleeving. Fusing rope ends also helps prevent unraveling after cutting the rope. Comes with 2-5/16" blade, operates on 110 AC volts, table top size, lighted on/off rocker switch, heats up to 1200°F, cuts and heat seals at the same time, 6.5' cord with ground.

RC48014 Cutter - \$159.99

RC48015 Replacement blades - \$29.99



PMI ROPE CORDAGE METER

Pull the rope through the meter the toothed measuring wheel and stainless steel pressure shoe assures uninterrupted no slip contact with the cordage. Features digital counter that adds or subtracts, resets to zero with one turn of knob, measures ropes and cordage from 1/4" - 3/4" diameter. Available in feet or metric measurements.

RC48003 Cordage per meter - \$449.99

RC48004 Cordage per feet - \$449.99

RC48006 Standard bracket - \$11.99

RC48005 Extended bracket - \$34.99





QUICK SHIP
NEW

RONIN LIFT POWER ASCENDER

Revolutionary, battery-powered rope ascender with a lightweight and durable design. Features a thumbwheel-trigger speed-control and a secondary lock for hands-free work. The battery is hot-swappable to keep you moving all day long. Designed to integrate with a wide range of climbing technology so it will most likely work with your existing gear. Offers a 400-lbs continuous lifting capacity and a variable lifting speed of up to 2 feet per second. Built with steel and aluminum components and weighs only 26 lbs with its largest battery pack.

2805-11 - \$1,574.99



RONIN LIFT POWER ASCENDER SPARE BATTERY

An additional battery with charger for 15 minutes of continuous use at 200 lbs. or 1500 ft. of rope. Equipped with a standard 120-240V charging plug.

508822 - \$349.99



QUICK SHIP
NEW

RONIN HARD CASE

Features a durable foam cut out that securely holds your Ronin Ascender. Rugged wheels for transportation across a variety of surfaces. Case also secures your gear by locking it with the built-in locking shackle. Protect your investment while keeping your gear secure and in proper working order.

100878 - \$449.99



ELK RIVER ROPEGUARD

Made of nylon web this 4" wide Ropeguard is designed to protect lifelines from wear caused by abrasion at points of contact with anchorage structures. Hook and loop closure allows easy installation at any point on the lifeline. The grommets permit the unit to be secured in place by a small cord (not included).

60901 4" x 1' - \$33.58

60902 4" x 2' - \$40.94

60903 4" x 3' - \$47.86

60904 4" x 4' - \$51.64



PWRs-G



PWRs-E

HARKEN POWERSEAT ASCENDER

The PowerSeat Ascender has revolutionized working at height, providing the worker with the ability to ascend quickly, stay in position longer, and work in comfort. The PowerSeat provides quality, convenience, safety, and is the best solution for completing a task on hand. Simple to use and ideal for a wide range of applications: wind turbines, building exteriors, search and rescue, not only as a powered ascender, but also as a portable winch or hauler. The compact version maximizes the efficiency of the PowerSeat as a hauling device, while maintaining their functionality as powered ascenders.

PWRs-GC Gas, compact - \$6,199.99

PWRs-G Gas, standard - \$6,699.99

PWRs-BC Battery, compact - \$7,499.99

PWRs-B Battery, standard - \$7,899.99

PWRs-EC Electric, compact - \$9,799.99

PWRs-E Electric, standard - \$10,299.99



MORROW GUIDE TO KNOTS

A compact, practical manual of (70) useful knots. From loops and bends to stopper knots and hitches, this guide includes step-by-step tying instructions, historical data, and useful tips.

BK13006 - \$16.99



PMI SUPERMANTLE ROPE PROTECTOR

Ballistic nylon exterior with canvas interior. Easy open flap, reflective strip, and tie off tab.

RC48020 Black (18") - \$22.75

RC48021 Green (18") - \$22.75

RC48018 Black (24") - \$25.00

RC48022 Red (24") - \$25.00

RC48023 Red (36") - \$34.99

RC48019 Black (36") - \$34.99

PMI SPIROLL

Effective, economical protection for stationary ropes. Rugged polyurethane material. Single rope use. For ropes greater than 9.5 mm. Perfect for anchors. Easily movable.

RC48032 Orange - \$12.00

RC48033 Black - \$12.00



* The ratings on these slings are the Minimum Break Strength (MBS), which is not a representation of their Working Load Limit (WLL), as they are not designed for maintaining a static load and are not intended for material handling.



WESTFALL PRO DYNEEMA ANCHOR SLING WITH RING

WestFall Pro 3/4" Dyneema Sling offers a web construction for weight savings and extra durability. There is an aluminum d-ring on one end for pass-thru anchorage. Rated for one user up to 310 lbs and Meets ANSI Z359.1 and OSHA 1926.502 standards.

711601 17" - \$27.99

711602 24" - \$32.99

711603 36" - \$41.99



NEW **QUICK SHIP**

STERLING ANCORE SLING

Designed for creating personal fall arrest anchors. Constructed with a dual layer webbing with yellow outer jacket and an orange inner layer. The inner layer provides a visual indicator should the sling become damaged.

SW254ANSL09024 24" - \$15.99

SW254ANSL09036 36" - \$17.99

SW254ANSL09048 48" - \$19.99

SW254ANSL09060 60" - \$21.99

SW254ANSL09072 72" - \$23.99

SW254ANSL09096 96" - \$27.99



VIDEO

STERLING 12 MM DYNEEMA SEWN SLINGS

Dyneema slings offer significant performance advantages over traditional runners. They are lightweight, have high cut resistance, are extremely strong, and resist moisture. MBS 5,170 lbs.

SW127DYSL

+0610 Blue (10") - \$8.30

+0424 Black (24") - \$11.42

+0724 Orange (24") - \$11.72

+0630 Blue (30") - \$14.81

+0448 Black (48") - \$19.84



STERLING 11/16" NYLON SLINGS

Sterling sewn runners are made with the highest quality webbing and computerized precision bar tacking making them exceptionally strong and lightweight. MBS 5,170 lbs.

SW174NYSL

+1412 Silver (12") - \$5.99

+0624 Blue (24") - \$6.64

+1930 Neon green (30") - \$8.38

+1448 Red (48") - \$10.99



PETZL ST'ANNEAU

Dyneema sling, lighter and more flexible than nylon slings. Very abrasion resistant. 12 mm width. End to end: 22 kN. Choker: 16 kN. Basket: 44 kN.

C07 24 24 cm - \$8.95

C07 60 60 cm - \$12.95

C07 120 120 cm - \$17.95

PETZL ANNEAU

Webbing loop. Also available in black. End to end: 22 kN. Choker: 16 kN. Basket 44 kN.

C40A 60 60 cm - \$7.95

C40A 80 80 cm - \$8.95

C40A 120 120 cm - \$9.95

C40A 150 150 cm - \$10.95



Durable rubber label



QUICK SHIP

BLUEWATER RHINO DUAL LAYER ANCHOR LOOP SLINGS

The construction essentially creates a loop inside a loop. Yellow outer for high visibility and fluorescent orange inner webbing to alert users of cuts or abrasions. Custom Dyneema thread makes overlap of sewn closure 1/3 the length of other slings. End to end: 11,000 lbf; choker: 10,000 lbf; basket: 15,000 lbf. Other lengths also available.

757002 24" - \$14.99

757003 36" - \$15.99

757004 48" - \$17.00

757005 60" - \$18.00

757006 72" - \$19.99





STERLING

Because it's a long way down.



PDQ2™ System

The PDQ2 is Sterling's lightweight evacuation system for use in all work-at-height environments. The PDQ2 descent-control device and the 6 mm XTEC™ heat-resistant Technora® rope form the core of this system whose total weight is under 10 lb. Rated for a user-load of 310 lb, the fully-assembled kit comes ready for deployment and its slim profile means it can be stored compactly and carried by each technician until needed.

For Sterling gear, talk to your employer or visit
SterlingRope.com/Work



ROCK EXOTICA AZTEK COMPACT SYSTEM

5/16" (8 mm) rope diameter. 4:1 mechanical advantage. Complete pre-rigged system with two Aztek pulleys, main 50' rope (8 or 9 mm), two Prusiks, a travel restrict Prusik and a compact bag to carry the pre-rigged kit in for rapid deployment. Can be used for pick off, travel restrict, adjustable directional, high directional guyline, load release hitch, and much more.

P41KIT-ASM - \$337.99

PETZL JAG SYSTEM

5/16" (8 mm) rope diameter, 16 kN breaking strength. Haul kit for pick-offs, making a releasable anchor, or tensioning a system, thanks to its 4:1 mechanical advantage and excellent efficiency (sheaves with sealed ball bearings). The collapsed kit is very compact, making usage possible even if the distance to the anchor is very short. Kit is quick and easy to deploy: it is ready to use thanks to the flexible cover that prevents any risk of tangling. The haul end is color coded for instant identification.

P044AA00 1 m - \$329.95

P044AA01 2 m - \$349.95

P044AA02 5 m - \$399.95

P44100 Replacement sleeve - \$17.99



ISC HAULERBINER COMPACT RESCUE KIT

Mechanical Advantage System which has three pulley wheels built into each carabiner, creating a compact, lightweight 6:1/7:1 Mechanical Advantage System; features anti-tangle sock, with pulley wheels located well above/below the sock to prevent the sock from becoming jammed in the pulleys; has a purpose designed progress capture cam, with a positive on/off action; utilizes specially developed 6 mm (1/4") diameter rope, for strength, easy handling and grip; supplied in a double pocket pouch for easy deployment and storage on the user's harness. Available in three standard kit lengths, with bespoke lengths available on special order.

HB105A 3'5" - \$263.68

HB165A 5'5" - \$283.97

HB300A 9'10" - \$324.53



WESTFALL PRO MINI HAUL KIT

5/16" (8 mm) rope diameter. Compact enough to not get in the way but strong enough to get the job done. The kit can provide 4:1 or 5:1 assistance depending on the configuration. Depending on how you rig the pulleys will determine the working length. Kit includes: (2) Auto-Locking Carabiners, (2) Pulleys, (1) Rope - 35' and (1) Prusik.

92035-1 - \$189.99



KTRNR

STERLING ROPE TOWER EMERGENCY DESCENT/ESCAPE SYSTEM

PDQ2 descent-control device and the 6 mm XTEC heat-resistant Technora rope form the core of this system whose total weight is under 10 lb (for a 100 M system). Fully-assembled kit comes ready for deployment and packed into a durable, weather-resistant carrying bag which allows it to be carried comfortably by the technician until needed. Custom lengths and configurations are available upon request.

KTPDQ2100 328' Rope - \$837.95

KTPDQ2120 394' Rope - \$839.40

KTRNR Raise & Rescue Kit - \$188.39



STERLING ROPE POCKET HAULER

5/16" (8 mm) rope diameter. This perfect mini mechanical advantage system can literally fit in a pocket; creates a 4:1 or 5:1 increase in force depending on orientation, for use in partner/self rescue, adjustable directions, piggy-backed haul systems, tensioning lines and multiple other rigging needs. Kit includes: (2) SR mini-double pulleys, 50' of 8 mm rope with sewn eye, (2) Hawk auto-lock carabiners, and 6 mm sewn ratchet screw link.

KTPHAULER - \$259.95



KITS
SAVE
CASH

QUICK SHIP

VIDEO



GME SUPPLY RESCUE KIT

Kit includes 7/16" Kernmantle Rope, GME Supply Orange Waterproof Rope Bag, WestFall Pro D4 Descender, PMI Easy Pick-Off Strap, (4) WestFall Pro 07400 4-7/8" x 3" steel carabiners, BlueWater Rhino 3' Dual Layer Anchor Loop Sling, and trauma shears. Upgrades available.

- 9024 150' - \$574.99
- 9025 300' - \$744.99
- 9035 600' - \$1,044.99



GME SUPPLY TOWER Z RIG RESCUE KIT

Kit includes 7/16" Kernmantle Rope, GME Supply Orange Waterproof Rope Bag, WestFall Pro D4 Descender, PMI Easy Pick-Off Strap, BlueWater Rhino 3' Dual Layer Anchor Loop Sling, (4) WestFall Pro 07400 4-7/8" x 3" steel carabiners, Petzl Ascension Rope Clamp/Ascender Grab, BlueWater Micro Pulley, WestFall Pro 07437 4-7/8" x 3" aluminum carabiner, and trauma shears.

- 9027 300' - \$809.99
- 9037 600' - \$1,109.99



PMI EASY PICK-OFF STRAP

PMI Easy Pick-Off Strap was designed to weigh less and take up less room too. A top performer in rescues, this strap allows for fluid transfer between systems. Adjustable length 7" to 42". 9.4 kN MBS, 2,100 lbf.

SG51180 - \$47.99



STERLING ROPE PICK-OFF STRAP

Adjusted from 10" - 59" in length. This pickoff strap allows slack to be removed from the system before transferring a load. Strap can be used as a durable anchor for basket and straight line configurations. End-to-End MBS Rating: 4,496 LBS (20 kN). Basket MBS Rating: 8,992 lbs (40 kN).

SW445NYPS0460 - \$37.50



PMI LADDER RESCUE KIT

Kit includes Progress Capture pulley, 2" heavy duty black nylon webbing ladder, aluminum bar rungs sewn into ladder, Static 11 mm nylon rope, ClimbTech ANSI steel carabiner, and ballistic nylon deployment bag.

KT36164 - \$665.00





GME SUPPLY STANDARD RESCUE KIT

Kit includes 7/16" Kernmantle Rope, GME Supply Orange Waterproof Rope Bag, WestFall Pro D4 Descender, PMI Easy Pick-Off Strap, (4) WestFall Pro 07400 4-7/8" x 3" steel carabiners, BlueWater Rhino 3' Dual Layer Anchor Loop Sling, BlueWater Ropes 4' Titan Sling, BlueWater Ropes Mini-Haul Tactical Kit, and trauma shears.

9026 300' - \$829.99

9036 600' - \$1,129.99



QUICK SHIP

VIDEO

KITS SAVE CASH

GME SUPPLY DELUXE RESCUE KIT

Designed for emergency pick-offs and rescue. Kit includes 7/16" Kernmantle Rope, GME Supply Orange Waterproof Rope Bag, WestFall Pro D4 Descender, PMI Easy Pick-Off Strap, (4) WestFall Pro 07400 4-7/8" x 3" steel carabiners, BlueWater Rhino 3' Dual Layer Anchor Loop Sling, WestFall Pro Chest Ascender, Rock Exotica Aztek Compact System, trauma shears. Upgrades available.

9050 300' - \$999.99

9075 600' - \$1,299.99

PETZL JAG RESCUE KIT

This reversible rescue kit is designed to easily pick off and lower a victim. Includes a Jag System Haul Kit, a Ring Open gated ring, an I'D S descender, a Connexion Fixe 150 cm anchor strap, a bucket bag, and an AXIS 11 mm rope with two sewn terminations.

K90030 30 m - \$799.95

K90060 60 m - \$899.95

K90120 120 m - \$999.95

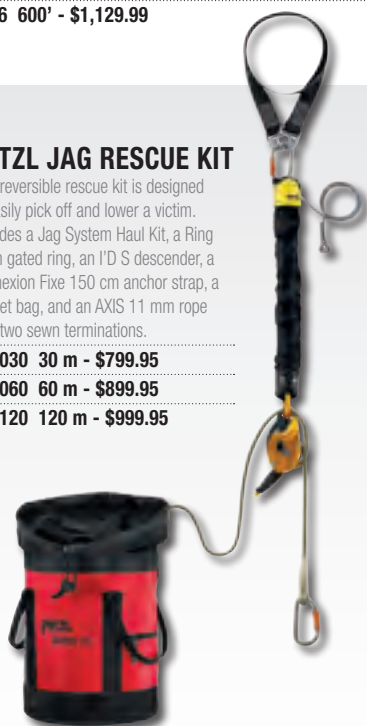

GME SUPPLY BASIC RESCUE KIT

Kit includes 150' of 7/16" Kernmantle Rope, Sterling Small Rope Bag, WestFall Pro D4 Descender, PMI Easy Pick-Off Strap, (4) GME Supply 07405 4-1/2" x 2-3/4" steel carabiners, BlueWater Rhino 3' Dual Layer Anchor Loop Sling, and trauma shears.

9010 - \$499.99



KITS SAVE CASH



COMPLETE YOUR ROPE ACCESS KIT

HARNESSES	24
POSITIONING	33
ANCHORAGE	45
HARDWARE	49
KERNMANTLE ROPE	56
ASCENDERS	62
BACKUP DEVICE	64
DESCENDERS	64
PULLEYS	65
BAGS	114
HELMETS	120
GLOVES	134



ISC RED BACKUP

3/8" (10.5 - 11) mm rope diameter. Positively locking spring self-parks device rather than tailing. Rotational braking means the device rotates clockwise creating friction, resulting in effective automatic braking in the event of a pull. 529 lbs capacity makes device suitable for 2 person rescue. Aluminum side plates. Meets EN 12841.

HWRP892 - \$119.99



TOWER-TEK RESCUE SOLUTION 100 M

Plug-and-play rescue solution for self-rescue, tower-based rescue, or ground-based rescue. ANSI compliant components, kit includes: 11 mm PMI Extreme Pro Rope, PMI Wire Rope Sling, Heightec Hurricane Pro, PMI D4 by ISC, 2" SMC Stainless Steel Pulley, Casualty Attachment Sling, (5) SMC FP Lite Alloy Carabiners, rescue shears, and carrying bag.

KT36172 - \$1,289.99



CSR2 PULLEY SYSTEM

CSR2 pulley is easy to release under load. Machined aluminum swivels at both ends eliminate potential twisting. Excellent for confined space or rope access rescue. System comes pre-rigged and packed in storage bag for quick access. Machined from solid block of aircraft-grade aluminum. Made in the USA. UL Classified to NFPA 1983, CSR2 Pulley MBS: 46 kN, CSR2 Double Pulley MBS: 45 kN.

500102 - \$1,299.99



EVO CHEST ASCENDER

1/2" (13 mm) rope diameter. Right handed chest ascender. External profile for opening lever makes climbing smooth and effective. Opening lever with integrated hole for easy grip when wearing gloves. Lower hole design ensures device stays parallel to user. Unlocking cam only requires single downwards movement. Anti-inversion cam system.

HD26253 - \$69.99



PETZL PANTIN FOOT ASCENDER

5/16" - 1/2" (8 - 13 mm) rope diameter. Cam facilitates passage of rope through device. Toothed and self-cleaning slot optimizes performance under any conditions. Mechanism is totally integrated into the body of the clamp to prevent rubbing. Releases from rope with simple backwards movement of foot.

B02CRA Right foot - \$79.95

B02CLA Left foot - \$79.95



HEIGHTEC QUADRA DESCENDER

Instantly switches from one mode to another while under load. Breaking mechanism increases frictional forces. Device will arrest a 2 person fall factor by 1/3 when in life lining mode with no rope damage. Retains full function after fall, stainless steel construction.

HD26175 - \$206.00



MBS
39 kN

ROCK EXOTICA 2.2" KOOTENAY ULTRA PULLEY

5/16" - 3/4" (8 - 19 mm) maximum rope diameter, 2.2" (56 mm) sheave diameter. Lightweight and compact and features a single locking screw. (2) holes to separate your tag/hoist lines and to prevent spinning.

P3 Standard color - \$225.00



STARTING AT \$744.99

BUILD YOUR OWN RESCUE KIT

ROPE & RESCUE // RESCUE EQUIPMENT

ANCHOR STRAP



Sterling anCORE Sling



Guardian Premium Cross Arm Strap

ROPE



WestFall Pro PSK With Eye



PMI 7/16" Extreme Pro With Eye

HARDWARE

KITS SAVE CASH



GME Supply Carabiner Pack



WestFall Pro 07430 Steel Carabiner



WestFall Pro 07475 Spreader Bar



WestFall Pro 07400 Steel Carabiner

ROPE BAGS



GME Supply Premium Rope Bag PMI Rope Pack

DESCENT DEVICE



Petzl Small I'D Descender WestFall Pro D4 Descender DBI Sala NoWorries Descender



Petzl Large I'D Descender WestFall Pro D5 Descender DBI Sala NoWorries Descender

PICK-OFF



PMI Easy Pick-Off Strap



PMI Jr Haul System

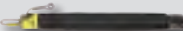

Petzl Jag Haul System



Rock Exotica Aztek Compact System



ISC Haulerbiner Rescue Kit

AVAILABLE EXCLUSIVELY AT GME SUPPLY www.gmesupply.com | (800) 940-6762



KITS SAVE CASH

GME SUPPLY TOWER RESCUE KIT

Designed for emergency pick-offs and rescue. Kit includes (2) Sterling anCORE Slings, PMI Advance Tech Haul System, Petzl Small I'D Descender, WestFall Pro Chest Ascender, GME Supply Orange Waterproof Rope Bag, 7/16" Kernmantle Rope with eye, (4) WestFall Pro 07400 4-7/8" x 3" steel carabiners, PMI Easy Pick-Off Strap.

9062 300' - \$1,245.00



KITS SAVE CASH

GME SUPPLY WIND RESCUE KIT

Designed for emergency pick-offs and rescue. Kit includes PMI Easy Pick-Off Strap, PMI Advance Tech Haul System, Petzl Small I'D Descender, WestFall Pro Chest Ascender, GME Supply Orange Waterproof Rope Bag, 7/16" Kernmantle Rope, (7) WestFall Pro 07436 4-7/8" x 3-1/8" aluminum carabiners, Guardian Premium Cross Arm Strap, Rock Exotica P22 Machined Rescue Pulley, Rock Exotica P21 Machined Mini Pulley.

9060 300' - \$1,250.00

(800) 940-6762



IN-STOCK, READY TO SHIP SAME DAY, CABLE SAFE CLIMB SYSTEMS



We inventory a large selection of Tuf-Tug stainless steel cable safe climb systems that are approved for installation by major tower site owners. These kits include all components required for common tower heights for Fixed Ladders, Monopoles, and Round Climbing Leg configurations. For further information, give one of our Gear Experts® a call.

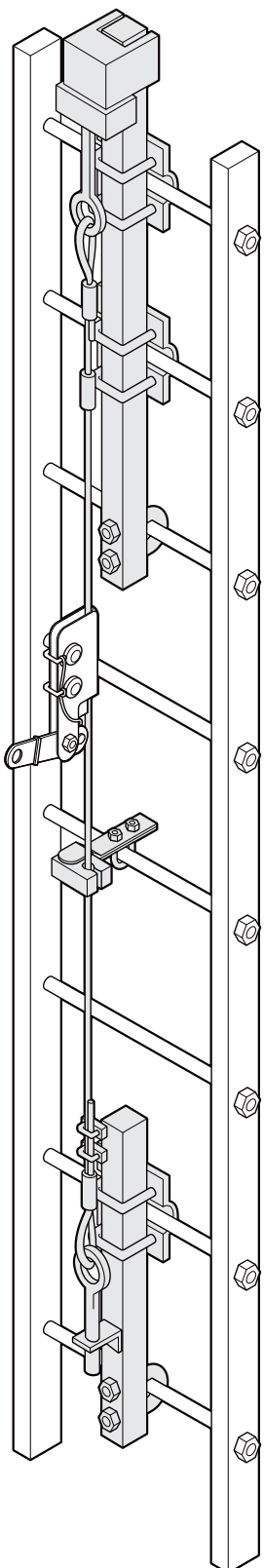

FIXED LADDER CABLE SAFE CLIMB SYSTEM

Includes: Stainless steel cable, factory swaged, and cut to length; Heavy duty upright mount bracket for solid rung ladders; Head assembly with impact attenuator; Ladder mount cable guides; Base anchor bracket assembly with tension adjustment eye bolt and cable clips. Quantity of components shown varies by system length.

- TTCSCS-100'L-SSC 100' - \$695.00
- TTCSCS-200'L-SSC 200' - \$825.00
- TTCSCS-250'L-SSC 250' - \$1,019.00
- TTCSCS-300'L-SSC 300' - \$1,150.00
- TTCSCS-400'L-SSC 400' - \$1,450.00



MONOPOLE CABLE SAFE CLIMB SYSTEM

Includes: Stainless steel cable, factory swaged, and cut to length; Head assembly with fasteners, spacer sleeves, and impact attenuator; Monopole cable guides; Monopole base anchor bracket with tension adjustment eye bolt, cable clips, and fasteners. Quantity of components shown varies by system length.

- TTCSCS-100'MP-SSC 100' - \$495.00
- TTCSCS-150'MP-SSC 150' - \$669.00
- TTCSCS-200'MP-SSC 200' - \$805.00
- TTCSCS-250'MP-SSC 250' - \$990.00



ROUND LEG CABLE SAFE CLIMB SYSTEM

Includes: Stainless steel cable; Universal round leg head adaptor bracket (fits 1.5"-5" leg); Round leg universal clamp channel assembly up to 8" diameter; Head assembly with impact attenuator; Stud mount cable guides with fasteners; Base anchor angle attachment with tension adjustment eye bolt, thimble, and cable clips. Quantity of components shown varies by system length.

- TTCSCS-150'RCL-SSC 150' - \$999.00
- TTCSCS-200'RCL-SSC 200' - \$1,160.00
- TTCSCS-250'RCL-SSC 250' - \$1,395.00
- TTCSCS-300'RCL-SSC 300' - \$1,575.00

PART	SYSTEM / UNIVERSAL	DESCRIPTION	PRICE
115-203	Ladder	Cable guide with fasteners	\$20.00
115-242	Ladder	90 Degree locking cable guide	\$40.00
115-303	Monopole	Angled cable guide	\$21.00
115-309/310	Monopole	Base anchor bracket with tension adjustable bolt	\$45.00
115-345	Monopole	Head extension bracket	\$111.00
115-345-CHANNEL MNT KIT	Monopole	Head extension kit for channel mount	\$101.00
115-345-DB	Monopole	Head extension for DBI Sala monopole system	\$106.00
115-154-45Y	Monopole or round leg	45 Degree formed step bolt anchor bracket	\$8.00
120-222	Monopole or round leg	Universal pole mount clamp on bracket	\$355.00
115-243	Round leg	1-1/2" - 5" Universal adapter bracket	\$ 184.00
115-317	Round leg	Stud mount cable guide with fasteners	\$21.00
115-334	Round leg	Locking stud mount cable guide with fasteners	\$35.00
115-RAK	Round leg	Wire rope grab right angle adaptor kit	\$8.00
120-203	Round leg	8" Universal clamp channel assembly	\$21.00
115-127	Universal	Cable climb system rain cap	\$8.00
115-135	Universal	6" Cable guide extension standoff	\$11.00



TRYLON COUGAR SAFETY CLIMB SYSTEM

ANSI-compliant and OSHA compliant, field-proven in extreme climates, excellent in confined spaces. Kits include appropriate length of aircraft cable, top and bottom support brackets, 12" tensioning turnbuckle, tension spring, and all hardware necessary for attachment to climbing ladders with ladder rungs up to 1.2" diameter. Intermediate cable guides included for 25' intervals.

4.99.0250.000 50' - \$423.99

4.99.0300.000 100' - \$544.99

4.99.0305.000 150' - \$665.99

4.99.0310.000 200' - \$690.99



NEW

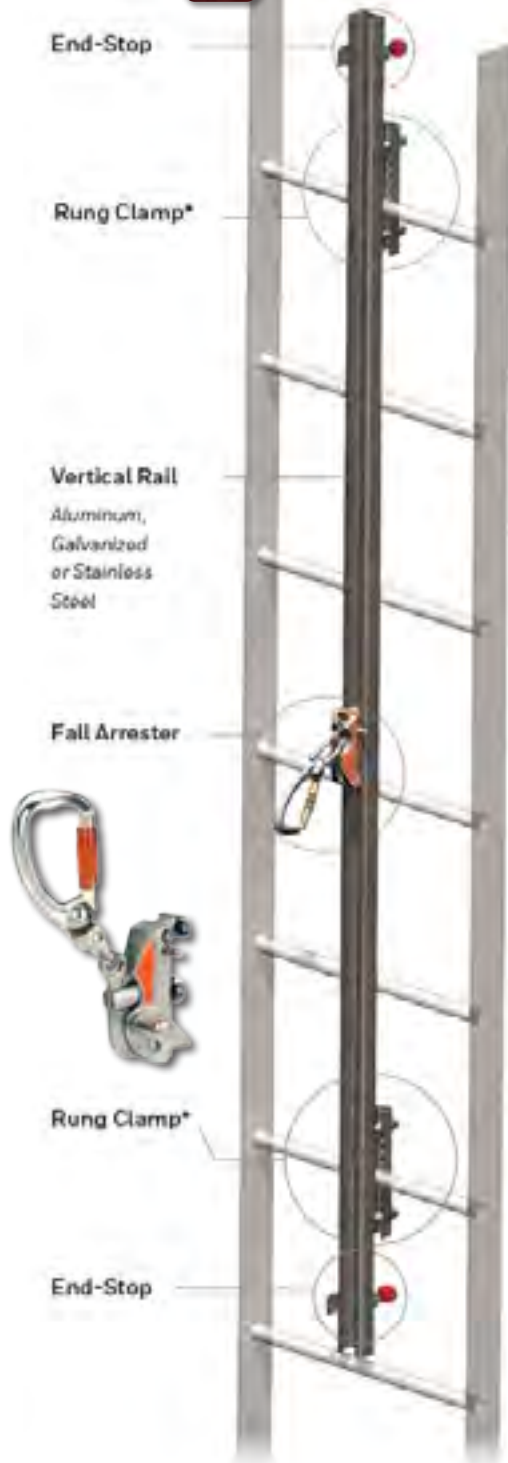

FRENCH CREEK VERTICAL FLEXIBLE CABLE CLIMBING SYSTEM

Includes top bracket, bottom bracket with tensioner, rung clamps for up to 1-1/8" diameter rungs, 3/8" galvanized wire rope lifeline permanently terminated at one end and clips on the other end. Standard lengths vary from 20' to 300' and include an appropriate amount of cable guides based upon length.

VL-38-20 20' - \$249.99

VL-38-50 50' - \$314.99

VL-38-100 100' - \$469.99

VL-38-150 150' - \$599.99

VL-38-200 200' - \$729.99



FRENCH CREEK WIRE ROPE GRAB

Stainless steel trailing wire rope grab for 3/8" wire rope.

1401-38 - \$175.49

1401A-38 With carabiner & shock absorber - \$192.49

MILLER GLIDELock RAIL LADDER CLIMBING SYSTEM - GALVANIZED

Provides an innovative solution for vertical climbing that is easy-to-use, requires minimal maintenance and provides superior safety. Easy-climb system increases user mobility, safety and productivity while ensuring smooth ascending/descending operations for one or multiple workers.

ML-GG0020 20' System - \$497.00

ML-GG0030 30' System - \$685.00

ML-GG0040 40' System - \$769.00

ML-GG0050 50' System - \$1045.00

ML-GG0060 60' System - \$1300.00

Additional Lengths / System Customization Available





DBI LAD-SAF FLEXIBLE CABLE LADDER SAFETY SYSTEM

DBI SALA STANDARD TOP BRACKET

Galvanized top bracket with mounting hardware, fits up to 1-1/8" rung diameter, attaches to (3) rungs, built-in energy absorber, for systems up to 499'.

6116280 - \$189.99
6116410 For systems over 500' - \$209.99

DBI SALA CABLE GUIDE

Non-metallic cable guide with mounting hardware, fits up to 1-1/8" rung diameter, must have one every 25', for systems up to 199'.

6100400 - \$39.99

DBI SALA CABLE LIFELINE

Galvanized cable, 3/8" (9.5 mm) diameter, 1 x 7 type. Last (3) digits in part number indicate length.

6110000 - \$1.30/ft

DBI SALA CABLE GUIDE

Non-metallic cable guide with mounting hardware, fits up to 1-1/8" rung diameter, for systems over 200'.

6100515 - \$39.99

DBI SALA LAD-SAF X3 FLEXIBLE CABLE SLEEVE WITH CARABINER

For use with 8 mm or 3/8" diameter 1 x 7 or 7 x 19 solid core cable. Comes with 2000112 carabiner. Meets OSHA and ANSI standards.

6160054 - \$434.99

DBI SALA STANDARD BOTTOM BRACKET

Fits up to 1-1/8" rung diameter, attaches to (2) rungs, tensioning device, galvanized.

6100090 - \$78.99



Fall Protection

NEW



3M DBI LAD-SAF STAINLESS STEEL CABLE VERTICAL SAFETY SYSTEM

Designed to meet the requirements of the new ANSI Z359.16 standard, along with OSHA 1910.140 and 1926.502, when used with the DBI Sala Lad-Saf X3 or X2.

Ordering is easy - the entire system is sold in a single SKU, including both brackets, pre-swaged cable, and cable guides. Reengineered to simplify and speed up installation process.

Fewer loose parts: Fewer than 13 separate components, up to 72% less than 3M | DBI Sala's previous comparable model. Weighs less than half of the previous system

Flexible: Mounting brackets can be used on a variety of fixed ladder styles that may consist of different rung spacings and shapes.

100% tie-off capability: Integrated fall arrested anchor point on top bracket rated to 3,600 lbs provides a simple location to transition from ladder to tower platform.

FOR SYSTEM PRICING CONTACT YOUR GEAR EXPERT!

The Lad-Saf Flexible Cable Ladder Safety System consists of a top and bottom bracket that act as anchors for a steel cable that runs the length of the climbing area. The Lad-Saf X3 sleeve, attached by carabiner to the harness, arrests falls by locking onto the cable. Designed for ease of use, economy and versatility, optional brackets/designs are available for bolting or welding the system. There is a choice of rung clamp sizes/styles and there are systems for straight ladders and for connection to wood, concrete or steel structures.

TENSION INDICATOR

Integrated tension indicating bottom bracket takes the guesswork out of installation.

CORROSION RESISTANT CONSTRUCTION

Galvanized and stainless steel construction stands up to harsh environments for maintenance free longevity.

SHOCK ABSORBING DESIGN

Integrated shock absorbing top bracket reduces forces imposed on ladder structure during a fall.

INTERMEDIATE CABLE GUIDES

Non-metallic cable guides prevent cable wear against the ladder and permits the climber to bypass without disconnecting.

GEAR EXPERTS®

“ We receive a lot of questions about whether the X2 or the X3 makes the most sense for our clients. They are nearly identical, but there are two key differences - one of which makes the X3 the predominant choice for tower work. The X2 is designed to accommodate systems with both 5/16" and 3/8" cable; the X3 is designed strictly for 3/8" 1x7 or 7x19 solid core cable. The X3 also includes an integrated RFID tag. The EIA/TIA requirement for 3/8" cable makes the X3 the preferred option of the two, as the slightly larger opening decreases binding. ”



TYLER NELSON

Southeast Regional Sales Manager



CSA
COMPLIANT

QUICK SHIP

DBI SALA LAD-SAF X3 DETACHABLE CABLE SAFETY SLEEVE

2.75 lbs. Sleeve for Lad-Saf fixed ladder safety system. For use on 3/8" (9.5 mm), 1 x 7 or 7 x 19 solid core cable. Easy installation and detach anywhere along lifeline. Mechanical and inertial locking system stops falls within inches. Built-in energy absorber and fall indicator with swivel. Anti-inversion feature prevents incorrect installation. Extremely rugged, compact, lightweight, and corrosion resistant construction. Integrated RFID tag.

6160054 - \$459.99



CSA
COMPLIANT

QUICK SHIP

MILLER VI-GO AUTOMATIC PASS-THROUGH CABLE SAFETY SLEEVE

For use with 5/16" or 3/8" diameter cable. Automatically bypasses intermediate cable guides keeping both hands free for climbing.

VGCS-SC With swivel carabiner (2.9 lbs) - \$401.49

VGCS-C With carabiner (2.0 lbs) - \$452.99

DBI SALA LAD-SAF X2 DETACHABLE CABLE SAFETY SLEEVE

2.6 lbs. Sleeve for Lad-Saf fixed ladder safety system. For use on 3/8" and 5/16", 1 x 7 or 7 x 19 solid core cable. Mobile design follows user for convenient climbing protection. Easy installation and detach anywhere along lifeline. Mechanical and inertial locking system stops falls within inches. Built-in energy absorber and fall indicator. Anti-inversion feature prevents incorrect installation. Rugged and corrosion resistant construction.

6160030 - \$439.99



TUF-TUG CABLE SAFETY SLEEVE

2.5 lbs. For use with 3/8" diameter cable system. Aluminum construction, self-tracking. Two man safe operation. Removable dual cam wire grab. Automatic hands free climbing. Meets ANSI ladder safety requirements.

TTWG-500 - \$224.99

SKYLOTEC CLAW CABLE SAFETY SLEEVE

2.2 lbs. For use with 3/8" and 5/16" diameter cable system. High quality lightweight stainless-steel construction. Replaceable shock absorbing pack. Anti-gravity locking system. Two-hand operation for increased safety. Swivel carabiner. Meets ANSI/ASSE A14.3-08, CSA Z259.22.5-17, OSHA.

CL-001 - \$399.99



THE RIGHT LIFT WHEN YOU NEED TO BE SWIFT

CHANCE® CAPSTAN HOIST

- Fast and quiet
- Rugged design handles tough jobs, extends service life and reduces maintenance



Safety is always first. Please visit hpstips.com/hoist for CHANCE Capstan Hoist safety recommendations.

AD_09_157_E



ENDURING PRODUCTS & PEOPLE
YOU CAN DEPEND ON
hubbelpowersystems.com





1,000 LBS
KITS SAVE CASH

AB CHANCE 1,000 LB STRAIGHT MOUNT CAPSTAN BUNDLE KIT

Kit includes AB Chance 1,000 lb capstan with foot control, AB Chance hitch mount kit, (2) Rock Exotica material handling 2.6" block, (2) LiftAll 4' green round slings, and WestFall Pro 1/2" Double Braid Rope. Rope MBS: 11,000.

- CAPKIT6 600' Rope, Rock Exotica blocks - \$3,374.99**
- CAPKIT12 1,200' Rope, Rock Exotica blocks - \$3,624.99**
- CAPKIT6-CY 600' Rope, Crosby McKissick blocks - \$3,449.99**
- CAPKIT12-CY 1,200' Rope, Crosby McKissick blocks - \$3,674.99**



1,000 LBS
QUICK SHIP
VIDEO

AB CHANCE CAPSTAN HOIST WITH FOOT CONTROL

1,000 lb load rating, 115 Volt AC, 40 ft/min rope speed, 14 amperes motor current, 45 lbs, (4) 3/8" mounting bolts are furnished with each unit, mounting flange provides (8) 3/8" tapped holes on 5-5/8" bolt circle.

- C3081170 Rope speed 40 ft/min, 1,000 lbs load rating, 3/8" bolts - \$2,699.99**
- C3081370 Rope speed 12 ft/min, 3,000 lbs load rating, 1/2" bolts - \$3,794.99**



1,000 LBS
QUICK SHIP
KITS SAVE CASH

AB CHANCE 1,000 LB SWIVEL MOUNT CAPSTAN BUNDLE KIT

Kit includes AB Chance 1,000 lb capstan with foot control, AB Chance hitch mount kit, (2) Rock Exotica material handling 2.6" block, (2) LiftAll 4' green round slings, and WestFall Pro 1/2" Double Braid Rope. Rope MBS: 11,000.

- CAPKIT6S 600' Rope, Rock Exotica blocks - \$3,874.99**
- CAPKIT12S 1,200' Rope, Rock Exotica blocks - \$4,174.99**
- CAPKIT6S-CY 600' Rope, Crosby McKissick blocks - \$3,924.99**
- CAPKIT12S-CY 1,200' Rope, Crosby McKissick blocks - \$4,224.99**

WATCH THE VIDEO ON OUR YOUTUBE CHANNEL



3,000 LBS

ESSENTIALKIT3000



1,000 LBS
QUICK SHIP
VIDEO

AB CHANCE ESSENTIALS KIT

Kit includes AB Chance 1,000 lb capstan with foot control, AB Chance hitch mount, and AB Chance swivel and C-Bracket.

- ESSENTIALKIT 1,000 lb capstan - \$3,274.99**
- ESSENTIALKIT/C3080856 With rope lock - \$3,434.99**
- ESSENTIALKIT3000 3,000 lb capstan with chain bracket - \$4,199.99**
- ESSENTIALKIT3000/C3080856 With rope lock - \$4,359.99**



3,000 LBS
VIDEO
KITS SAVE CASH

AB CHANCE 3,000 LB CAPSTAN BUNDLE KIT

Kit includes AB Chance 3,000 lb capstan with foot control, AB Chance chain bracket, (2) Crosby 4.5" blocks, (2) LiftAll 4' red round slings, and WestFall Pro 5/8" Double Braid Rope. Rope MBS: 17,000.

- CAPKIT6XL 600' Rope - \$5,449.99**
- CAPKIT12XL 1,200' Rope - \$5,949.99**

MY-TE SWIVEL MOUNT

Swivel mount bolts to your truck bed with (4) 1/2" bolts, capstan winch frame bolts to swivel mount using tapped mounting holes and hardware provided, winch rotation allows you to use your winch even when your truck is in an awkward location, pin stop locks swivel base in one position.

148331 - \$285.00



MY-TE POLE MOUNT ADAPTER

Sturdy steel construction with mounting bolts for bolting adapter to winch frame. Comes with chain tightener for securing to pole, allows same base-mounted unit to be used in either installation.

148353 - \$590.00





GO TO WWW.GMESUPPLY.COM/RIGGING
TO VIEW ALL LIFTING & RIGGING GEAR



AB CHANCE CAPSTAN FOOT CONTROL

Replacement foot control for AB Chance 115 V or 230 V AC Capstan Hoists. Power Source: 115 V AC electric motor; weight: 3.92 lbs.
C4170337 - \$244.99



AB CHANCE CHAIN BRACKET

All-purpose bracket, includes two chain clamps.

C3081335 1,000 lb series - \$544.99
C3081443 3,000 lb series - \$644.99



WELD-LOK REINFORCED STRAIGHT CAPSTAN MOUNT

Patent-pending design featuring reinforced Weld-Lok technology; strong, durable, and made for tough jobs; load rated at 1,000 lbs, engineered and manufactured in the U.S.
SM1170 - \$174.99

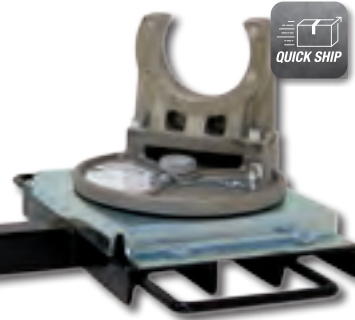

AB CHANCE HITCH MOUNT KIT

Includes C3080903, C3080890, and T3080999; provides fast mounting for 1,000 lb capstans.

PSC3081563 Kit - \$824.95
T3080999 Hitch mount - \$364.99
C3088017 Hardware for attachment - \$9.99
C3080903 Swivel bracket - \$364.99
C3080890 C-bracket - \$144.99
T3081506 Swivel & C-bracket - \$542.99



MY-TE CAPSTAN HOIST

800 lb single-line or 1,600 lb double-line lift, 115 Volt AC or 12 volt DC brake motor with triple brake system for instant stopping, low voltage 10' pendant hand or foot control, heavy-duty angle base drilled for four 1/2" bolts (9/16" mounting holes) with no welding required, fully sealed aluminum housings with precision-cut gears run in an oil bath, hardened steel worm and forged bronze worm gear holds load in position when stopped, stress-proof drum shaft, frictionless bearings, 175:1.

30-12 12 Volt DC - \$1,950.00
300AB 115 Volt AC - \$2,135.00



CHANCE®



AB CHANCE ROPELOCK

Rope lock device for Series 90 hoists, includes mounting bolts and washers.

C3080856 - \$184.99



AB CHANCE REPLACEMENT ROPE HOOK

Prevents the rope or load line from slipping off the end of the capstan drum, acts as a guide by keeping the rope in the proper position while the capstan is operating.

P3081509 Hook - \$29.99

P3081517 Hook with tamper-resistant bolt - \$35.99



AB CHANCE CHERRY SWITCH

Switch for AB Chance foot pedal.

P3080708 - \$29.95



AB CHANCE CAPSTAN LABELS

These labels keep the user informed of the potential risks associated with using and operating a capstan. Includes (1) danger label and (1) warning label for use on C3081170 (1,000 lb capstan).

HB-RMD-1170 - \$9.95



AB CHANCE HEX KEY WRENCH

Hexagon key to 7/32 bolts.

Z030 - \$20.00



MY-TE RECEIVER HITCH MOUNT

Bolts to the capstan winch-hoist in order to mount the unit using a utility truck's 2" receiver hitch, shipped with hardware, hitch pin is not included, mounting plate may be used with any My-Te frame style capstan winch.

148452 - \$90.00



ASME B30 COMPLIANCE

ASME B30 STANDARD FOR LIFTING & RIGGING

Chapter 26-5 of the ASME B30 Standard covers rigging blocks, like those that you'd use with a capstan hoist. Here's what you need to know about the standard*. Have more questions? Give our Gear Experts® a call!

MATERIALS

The block should be able to permanently deform before losing the ability to support the load. This ensures that you should notice the block has been overloaded before it falls.

Side plates should be of metal, wood, or a synthetic material. You'll almost always see steel or aluminum blocks in the tower industry. The sheaves and load-bearing straps or fittings should be made of metal, as well.

SAFE DESIGN FACTOR

Rigging blocks must have a minimum safety factor of 4.

RATED LOADS

Always keep your total load inside of the recommended limits set by the manufacturer. And

remember that this is the maximum load applied, not a single line load. Meaning if the block is rigged at the top of the tower and you're lifting something that weighs 1,000 pounds, there could be up to 2,000 pounds on the block. Check out competent rigger training courses for more on these concepts. (Page 207)

IDENTIFICATION

Each block has to have markings for manufacturer, rated load, and acceptable rope sizes. The block should also be maintained by the user to insure these markings remain legible through the life of the hardware.

TRAINING

Users must be properly trained to select, inspect, and fully use the blocks. That means not just in proper rigging, but also this very standard.

INSPECTION, REPAIR, & REMOVAL FROM SERVICE

A qualified person should designate whether the hardware is suitable for rigging, and remove from service if it's not. Prior to use, all blocks should be inspected to verify compliance with ASME B30. A visual inspection should be performed each time the block is used. Permanently installed rigging hardware should have periodic inspections as well.

Repairs or modifications must be specified by the manufacturer or a qualified person. The replacement parts should meet or exceed the original manufacturer specifications. Unless advised by the manufacturer, modifications are not recommended.

OPERATING PRACTICES

Obviously, load ratings should not be exceeded. Make sure you're keeping clear of the block, its running lines, load, or any other part of the system during lifting. That includes walking or standing under a

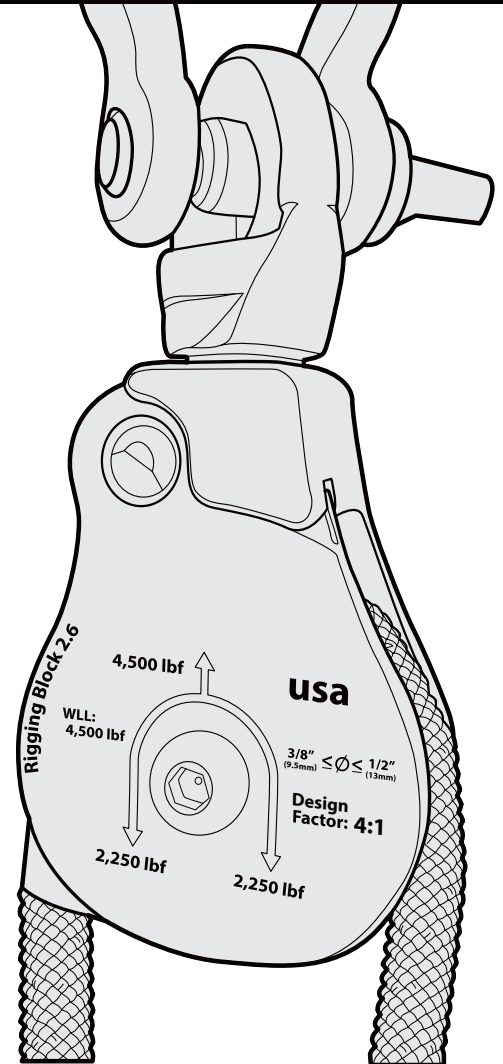

suspended load, or lifting line. Also, don't stand next to the rigging when the line is under tension.

The load applied to the block should be in-line with the sheave to prevent side loading. Blocks with swivels help to avoid these problems. Also, make sure your rope is securely in the groove of the sheave. Shock loading should also be avoided.

*This is not a comprehensive training guide.

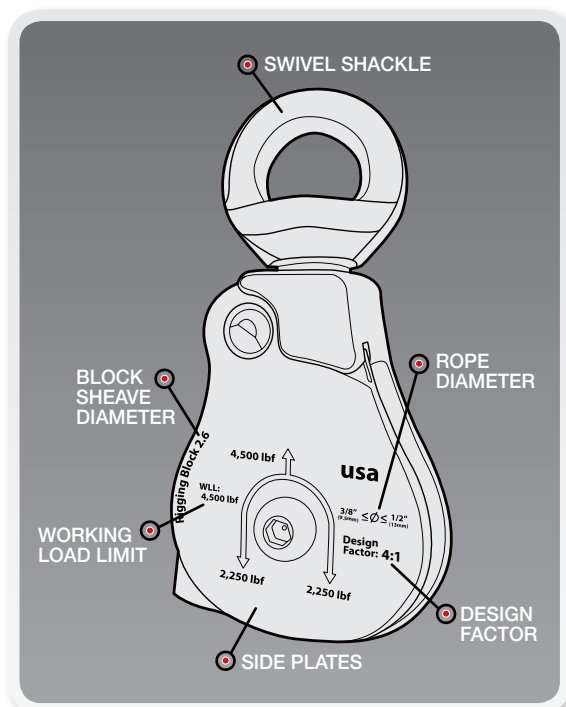

FREE
DOWNLOAD

ASME
B30
COMPLIANT

LOOK FOR THIS
BADGE THROUGHOUT
THE CATALOG.

WESTFALL PRO



WESTFALL PRO LOAD LINE

The WestFall Pro Load Line is designed specifically for use with capstan hoists. This load line has a number of unique traits that set it apart from other double braid rope on the market.

Key Features: Unique sheath design gives it superior snag resistance and prevents particles and debris from penetrating the rope, extending the life and strength of the rope • Terminated ends for easy, versatile rigging options, no need for knots or termination plates which decrease rope strength • Protective sheath increases life of rope by protecting high-wear areas • High contrast tracers for increased rope visibility over other single color tracers • Improves perception of speed while lifting and lowering, seeing contrasting motion of orange and blue tracers makes it clear how fast rope is moving from hundreds of feet away • Durable serialized ID label for inspection tracking.

LENGTH	DIAMETER	STRENGTH	PART	PRICE
300'	3/8" (10 mm)	MBS 5,000 lbs	LL120300	\$125.00
300'	1/2" (13 mm)	MBS 11,000 lbs	LL160300	\$195.00
300'	5/8" (16 mm)	MBS 17,000 lbs	LL200300	\$300.00
600'	3/8" (10 mm)	MBS 5,000 lbs	LL120600	\$240.00
600'	1/2" (13 mm)	MBS 11,000 lbs	LL160600	\$380.00
600'	5/8" (16 mm)	MBS 17,000 lbs	LL200600	\$600.00
1,200'	3/8" (10 mm)	MBS 5,000 lbs	LL121200	\$480.00
1,200'	1/2" (13 mm)	MBS 11,000 lbs	LL161200	\$750.00
1,200'	5/8" (16 mm)	MBS 17,000 lbs	LL201200	\$1,200.00



WLL
4,500 LBF



ROCK EXOTICA MATERIAL HANDLING 2.6" BLOCK

Red side plate to easily differentiate material handling block from P55 omni-block pulley. Install and remove rope while still connected to the anchor. Side plate locks with two-stage, double-catch safety mechanism. Integrated swivel allows pulley to orient while reducing gain. 4,500 lbf WLL. ASME B30 compliant.

MHP55 - \$220.00

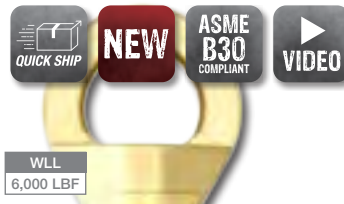

WLL
6,000 LBF



ROCK EXOTICA MATERIAL HANDLING 4.5" BLOCK

A game changing block, new to the scene in Lifting and Rigging. Features a large 4.5" sheave and 6,000 lbf WLL. Designed with 3,000 lb capstan hoists in mind, can handle 3/4" rope and is ASME B30 Compliant. Red side plates to easily differentiate it from other blocks which aren't designed for overhead lifting. Targeted to the industrial user, where ASME B30 compliance for material handling is a must.

MHP58 - \$395.00



STERLING ROPE 1/2 INCH VERGO LOAD LINE

Specifically made for the tower industry and is ideal for use with a capstan. Made from polyester, VerGo load line is constructed with a braided core for strength. Optimized braid angle offers maximum durability for hauling up and down the tower.

VG125000092SP 1/2" 300' - \$229.95

VG125000183SP 1/2" 600' - \$445.95

VG125000366SP 1/2" 1,200' - \$878.95





WHEN YOUR WORK IS ON TOWERS...

MAKE OMNIS YOUR BLOCKS.

The Omni rigging blocks feature up to 1/2" or 3/4" rope capacity, and 4,500 or 6,000 lbf WLL to accommodate your rigging needs.

- Rotating swivel eye
- Push-button opening sideplate
- For fiber rope



ROPE CAPACITY
3/4"
 WORKING LOAD
6,000 lbf

ROPE CAPACITY
1/2"
 WORKING LOAD
4,500 lbf



rock exotica®



ASME
B30
 COMPLIANT



CROSBY MCKISSICK SYNTHETIC ROPE BLOCK

1/2" synthetic rope diameter. Steel block with shackle top is used with synthetic rope. 2 ton working load limit. ASME B30 compliant.

8044078 3" sheave diameter - \$209.99

8048587 4.5" sheave diameter - \$424.99

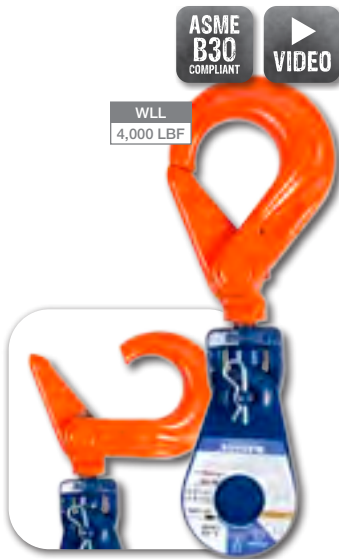

CROSBY MCKISSICK SHUR-LOC SYNTHETIC ROPE BLOCK

3" sheave diameter. Made from steel. Shur-Loc hook has a positive lock latch that is self-locking when the hook is loaded. The replacement of the shackle with a hook removes the need to use a wrench to load the block increasing productivity while on the job. ASME B30 compliant.

3521432 1/2" synthetic rope diameter - \$253.99

3521482 5/8" synthetic rope diameter - \$403.99



CROSBY CARBON L-320C EYE HOOK WITH LATCH

PART	WLL	TYPE	PRICE
1022216	1 ton	L-320CN Self-colored	\$26.05
1022227	1.5 tons	L-320CN Self-colored	\$27.10
1022238	2 tons	L-320CN Self-colored	\$33.90
1022246	3 tons	L-320CN Self-colored	\$54.20
1022211	1 ton	S-320CN Galvanized	\$12.42
1022222	1.5 tons	S-320CN Galvanized	\$15.89
1022233	2 tons	S-320CN Galvanized	\$21.72
1022244	3 tons	S-320CN Galvanized	\$41.19

CROSBY SNATCH BLOCKS

PART	STYLE	WLL	SHEAVE	PRICE
108038	Hook	2 tons	3"	\$187.10
109037	Shackle	2 tons	3"	\$188.70
108065	Hook	4 tons	4.5"	\$345.00
109064	Shackle	4 tons	4.5"	\$331.00

WESTFALL PRO SNATCH BLOCKS

PART	STYLE	WLL	SHEAVE	PRICE
2010	Hook	2 tons	3"	\$114.99
2000	Shackle	2 tons	3"	\$114.99
2015	Hook	4 tons	4.5"	\$199.99
2005	Shackle	4 tons	4.5"	\$199.99

SNATCH BLOCKS

PART	STYLE	WLL	SHEAVE	PRICE
SB3H	Hook	2 tons	3"	\$47.25
SB3S	Shackle	2 tons	3"	\$47.25
SB3TB	Tailboard	2 tons	3"	\$44.75
SB412H	Hook	4 tons	4.5"	\$84.00
SB412S	Shackle	4 tons	4.5"	\$87.25
SB412TB	Tailboard	4 tons	4.5"	\$78.75
SB6H	Hook	8 tons	6"	\$141.75
SB6S	Shackle	8 tons	6"	\$148.00
SB6TB	Tailboard	8 tons	6"	\$115.50

SWIVEL HOOKS

PART	WLL	PRICE
EH1TASLP	1 ton	\$25.20
EH112TASLP	1.5 tons	\$27.30
EH2TASLP	2 tons	\$31.50
EH3TASLP	3 tons	\$36.75
EH5TASLP	5 tons	\$42.00
EH7TASLP	7 tons	\$89.25



DAS / LTE 2 INCH ANTENNA PIPE ROOSTER HEAD

Hoists DAS/LTE antennas up the tower into position for a quick and safe installation. Slides into standard 2" pipe mount. Max 250 lbs lift load capacity. 4" Pulley with oversized groove. Use with 1/2" diameter rope or 3/8" diameter wire rope.

TT2-APRH - \$189.99



BUCKINGHAM OX BLOCK

5/8" (16 mm) maximum rope diameter. Snatch block with integrated friction bar. For use with rescue, lower loads, snubbing loads, and raising loads. Eye to Hook: 6,000 lbs MBS. Eye to Sheave: 10,000 lbs MBS.

50061 - \$411.10





DILLON QUICK-CHECK RED TENSION METER

Ideal for cable guardrails, guy lines and overhead wires. The digital load cell is rugged, highly repeatable and accurate. The tension meter can be placed on a cable, measure its tension, and removed in under five seconds. There are no complex lookup tables or conversion charts - saving time and money. Select from 20 pre-calibrated wire sizes and types stored in Quick-Check's memory. Graphically displays the current and target tension control limits for extremely quick setting of line tension. Quick-Checks can be purchased in different capacities with individual cable calibrations. Additional calibrations can be added at time of order. Also available is an pre-loaded option with all common tower cable sizes from 3/16" to 1" in both 1 x 7 and 1 x 19 construction.

AWT05-508112 2,000 x 2 lbf, Single wire calibration - \$2,660.00

AWT05-508111 10,000 x 10 lbf, Single wire calibration - \$2,785.00

AWT05-508251 10,000 x 10 lbf, Pre-calibrated with all standard tower calibrations - \$4,390.00



STRAIGHTPOINT COLT TENSION METER

Lightweight, versatile clamp on line tension meter for guy wire, steel wire, and rope. Perfect for fast and accurate measurement of wire rope tensions up to 11,000lbf / 5,000 kgf and up to 1 in (25 mm) diameter. Constructed from aerospace grade aluminum and comes with a purpose made carry case and is fully portable and utilizes standard alkaline batteries.

COLT5T - \$3,596.00



TUF-TUG TOTE TUGGER

Solid steel construction, heavy-duty, dual ratchet drive design. 7.5' reach, 3,000 lbs pull capacity, 1,500 lbs lift capacity. 3/16" cable diameter. 6" double line lift height. 12' cable length. Folds into compact carrying case, folding handle.

TT3000-7.5C-FHB - \$49.99

ROCK EXOTICA ENFORCER LOAD CELL

Compact aluminum load cell that measures force up to 20 kN. Lightweight aluminum construction. Facilitates "in-line" use in rigging systems. Swivel attachment points diminish potentially dangerous torsional and off-axis forces. Features (2) sampling modes: "slow" for monitoring and "fast" for break-testing. Monitor forces wirelessly on your iPhone with built-in Bluetooth connectivity. Record and download graphs of dynamic events. Measures force in kg, lbf, and kN.

LC1 - \$800.00



VIDEO

CST/BERGER 5" DIGITAL THEODOLITE TRANSIT

Simple enough for the untrained construction worker yet still more sophisticated and accurate than conventional contractor-style transits, this theodolite measures vertical and horizontal angles. There is a vertical tilt sensor and an LCD backlit display.

56-DGT2 - \$1,127.99



NEW

QUICK SHIP

DILLON ED JUNIOR DYNAMOMETER

Capacities from 2,500-25,000 lbs. Generous shackle openings mate with most hooks and hardware. 0.2% accuracy. High specification materials on all load components. Heat treated to tight tolerances. Broadest range of capacities and resolutions are certain to fit your needs. NIST Traceable Certificate included. Largest safety factor for overload protection and long life.

AWT05-506319 - \$1,585.00



DILLON EDXTREME DYNAMOMETER

Available in capacities from 2,500 - 550,000 lbf. This dynamometer has capabilities ranging from being something as simple as a digital scale to offering a higher level of intelligence with user-defined functions and sophisticated communication options. The EDxtreme readily adapts to multi-tasking operations or multi-link systems capable of monitoring a series of critical stress points from a single location. Compatible with EDxtreme Communicator II.

AWT05-506312 - \$1,990.00



DILLON EDXTREME COMMUNICATOR II

A hand-held radio ready controller for EDxtreme units. Extremely powerful hand-held remote that can define the function and manage the operation of one or more EDxtreme dynamometers using wired or radio technologies. Through the programmable Softkey interface, one or more Communicators can monitor multiple dynamometers within the same airspace. In multiple-link lifting arrays, the Communicator can display readings at any or all lift points and calculate the total load.

AWT05-506447 - \$1,445.00



DILLON AP DYNAMOMETER

Available in capacities from 500 - 20,000 lbf. Generous shackle openings mate with most hooks and hardware. 0.5% accuracy. High specification materials on all load components. Heat treated to tight tolerances. Wide temperature range for use in nearly any environment.

3006-0019 - \$1,140.00





GREENLEE REEL STAND SPINDLE

Steel spindle with grooves to fit reel stand rollers, for 683 reel stand, 2-3/8" x 76" 5,000 lb capacity.

684 - \$259.99

647 For 687 reel stand 2-3/8" x 62" - \$198.99



GREENLEE JACKSTAND REEL STAND ASSEMBLY

Wide, welded steel base for added stability with 5/8" holes, roller bearings fit in the spindle groove to keep the spindle in place and turning freely, (2) stands and a spindle are required for a complete setup, 2,500 lb capacity, base 24" x 23", height 21" x 54".

683 - \$254.99



GREENLEE TELESCOPING REEL STAND ASSEMBLY

Wide, welded steel base for added stability with 5/8" holes, roller bearings fit in the spindle groove to keep the spindle in place and turning freely, (2) stands and a spindle are required for a complete setup, base 14.5" x 20", height 13" x 28".

687 - \$179.99



SUMNER NO. 70 SCREW-TYPE REEL MAC REEL JACK

Screw-type telescoping, for 46" to 96" diameter reels, height: 21"-54", capacity: 2,500 lbs, use with No. 71 spindle, self-lubricating bearings, built-in handle storage, patent pending safety head.

780942 - \$244.99



SUMNER NO. 60 SCREW-TYPE REEL MAC REEL JACK

Screw-type telescoping, for 26" to 56" diameter reels, height: 13"-27", capacity: 2,500 lbs, use with No. 61 spindle, self-lubricating bearings, built-in handle storage, patent pending safety head.

780941 - \$174.99



SUMNER NO. 75 ECONO MAC REEL JACK

Lighter design that does require any loose pins, Self-lubricating roller bearings, no grease required, one-bolt disassembly, no welding required for service, double pronged pins, 23.75" to 52.75" range, 2,500 lbs capacity.

780935 - \$218.99



SUMNER NO. 71 SPINDLE FOR REEL MAC

Screw-type, diameter: 2-3/8", length: 76", capacity: 5,000 lbs, use with No. 70 Reel Mac Reel Jack, all steel construction, rugged design for job site use.

780230 - \$159.99

780229 For No. 61 reel stand 2-3/8" x 62" - \$124.99



SUMNER HI FOLD-A-JACK

Can be folded up for easy storage and includes a carrying handle. Strut tension plate for superior lateral support. Set screw can lock jack head to stand. Built tough for heavy use. Can be adjusted from 28" to 49". 2,500 lbs load capacity.

781300 With vee head - \$90.99

781301 With roller head - \$112.00



SUMNER HI HEAVY DUTY PIPE JACK STAND

Constructed of rugged 1" steel tubing, tested by independent labs for excessive loads. Features large adjustment handle, quick-action lock washer, and 1-1/2" Acme fine adjustment thread. Patented Fall Guard feature allows 1" (25 mm) safety zone around lock washer. Built for heavy use & abuse. 2,500 lbs load capacity.

780375 With vee head - \$81.99

780376 With roller head - \$112.99

CROSBY SHUR-LOC HANDLE SWIVEL HOOK S-13326AH

PART	CHAIN SIZE	WLL 4:1	WLL 5:1	WEIGHT	PRICE
1005014	5/8"	10.3 tons	8.2 tons	26 lbs	\$956.00
1005023	3/4"	16.0 tons	12.8 tons	37 lbs	\$1,445.00
1005041	7/8"	19.4 tons	15.5 tons	57 lbs	\$1,957.00
1005050	1"	27.1 tons	21.7 tons	84 lbs	\$2,375.00



CROSBY SHUR-LOC HANDLE EYE HOOK S-1316AH

PART	CHAIN SIZE	WLL 4:1	WLL 5:1	WEIGHT	PRICE
1023579	5/8"	10.3 tons	8.2 tons	18 lbs	\$483.00
1023599	3/4"	16.0 tons	12.8 tons	28 lbs	\$761.00
1023607	7/8"	19.4 tons	15.5 tons	39 lbs	\$988.00
1023625	1"	27.1 tons	21.7 tons	60 lbs	\$1,559.00



WIRE CABLE

PART	CLASS	DIAMETER	APPROX WEIGHT PER 1,000 FT	BREAKING STRENGTH	PRICE/FT
GA3819	7 x 19, galvanized	3/8"	243 lbs	7.2 tons	\$0.70
SA3819	7 x 19, stainless steel	3/8"	243 lbs	6.0 tons	\$1.55

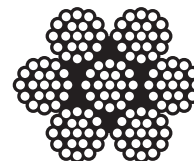

CROSBY FORGED WIRE ROPE CLIPS

PART	SIZE	(A)	(B)	(C)	(D)	(E)	(F)	(G)	(H)	WEIGHT	PRICE
1010051	1/4"	0.31"	1.03"	0.50"	0.75"	0.66"	0.56"	1.19"	1.43"	0.19 lbs	\$5.62
1010079	5/16"	0.38"	1.38"	0.75"	0.88"	0.73"	0.69"	1.31"	1.66"	0.28 lbs	\$5.88
1010097	3/8"	0.44"	1.50"	0.75"	1.00"	0.91"	0.75"	1.63"	1.94"	0.48 lbs	\$6.23
1010113	7/16"	0.50"	1.88"	1.00"	1.19"	1.13"	0.88"	1.91"	2.28"	0.78 lbs	\$9.67
1010131	1/2"	0.50"	1.88"	1.00"	1.19"	1.13"	0.88"	1.91"	2.28"	0.80 lbs	\$9.92
1010159	9/16"	0.56"	2.25"	1.25"	1.31"	1.34"	0.94"	2.06"	2.50"	1.10 lbs	\$12.25
1010177	5/8"	0.56"	2.25"	1.25"	1.31"	1.34"	0.94"	2.06"	2.50"	1.11 lbs	\$12.57



CROSBY JAW & JAW TURNBUCKLES

Heat treated bodies and quenched and tempered end fittings. Recommended for straight or in-line pull only. Meets or exceeds all requirements of ASME B30.26. Forged jaw ends are fitted with bolts and nuts for 1/4"-5/8", and pins and cotters on 3/4"-2-3/4" sizes. Available in multiple lengths and end fittings.

- 1032554 1/2" x 6" - \$54.90
- 1032616 5/8" x 6" - \$79.30
- 1032670 3/4" x 6" - \$106.40



ASME B30 COMPLIANT

CROSBY JAW & EYE TURNBUCKLES

Heat treated bodies and quenched and tempered end fittings. Recommended for straight or in-line pull only. Meets or exceeds all requirements of ASME B30.26. Forged jaw ends are fitted with bolts and nuts for 1/4"-5/8", and pins and cotters on 3/4"-2-3/4" sizes. For turnbuckle sizes 1/4" - 2-1/2", a shackle one size smaller can be reeved through eye. Available in multiple lengths and end fittings.

- 1031939 1/2" x 6" - \$49.15
- 1031993 5/8" x 6" - \$68.00
- 1032055 3/4" x 6" - \$102.20



ASME B30 COMPLIANT

CROSBY EYE & EYE TURNBUCKLES

Heat treated bodies and quenched and tempered end fittings. Recommended for straight or in-line pull only. Meets or exceeds all requirements of ASME B30.26. For turnbuckle sizes 1/4" - 2-1/2", a shackle one size smaller can be reeved through eye. Available in multiple lengths and end fittings.

- 1031314 1/2" x 6" - \$47.05
- 1031378 5/8" x 6" - \$57.10
- 1031430 3/4" x 6" - \$100.60



ASME B30 COMPLIANT

CROSBY HOOK & EYE TURNBUCKLES

Heat treated bodies and quenched and tempered end fittings. Recommended for straight or in-line pull only. Meets or exceeds all requirements of ASME B30.26. For turnbuckle sizes 1/4" - 2-1/2", a shackle one size smaller can be reeved through eye. Hooks are forged with a greater cross sectional area that results in stronger hook with better fatigue properties. Available in multiple lengths and end fittings.

- 1030690 1/2" x 6" - \$51.70
- 1030752 5/8" x 6" - \$72.90
- 1030814 3/4" x 6" - \$103.10



ASME B30 COMPLIANT

BLACK PAINTED STEEL EARTH SCREW ANCHOR

May be installed by hand or machine. The eye on the rod has a large opening to admit a turning bar for screwing the anchor down. The eye will also fit into an adapter available from most hole-boring machine manufacturers so the anchor may be power-installed. Consists of a drop-forged steel eye rod welded to a steel helix.

- ES-30 30" - \$8.99
- ES-48 48" - \$19.99



GALVANIZED STEEL EARTH SCREW ANCHOR

May be installed by hand or machine. The eye on the rod has a large opening to admit a turning bar for screwing the anchor down. The eye will also fit into an adapter available from most hole-boring machine manufacturers so the anchor may be power-installed. Consists of a drop-forged steel eye rod welded to a steel helix. Hot-dip galvanized for long resistance to rust.

- EG-30 30" - \$14.99
- EG-48 48" - \$24.99
- EG-54 54" - \$44.99
- EG-80 66" - \$99.99
- EG-96 96" - \$154.99





GME SUPPLY SHACKLE PACK

Includes (2) Crosby 1/2" galvanized screw pin shackles, (4) Crosby 3/4" galvanized screw pin shackles, and (6) Crosby 5/8" galvanized screw pin shackles. These shackles are forged - quenched and tempered, with alloy pins. Approved for use at -40° F to 400° F. Meets or exceeds all requirements of ASME B30.26. Statistical proof and impact tested. Proof testing and certification available upon request.

SHACKLEPACK - \$304.99



GME SUPPLY GUY WIRE CHANGE KIT

Kit includes (3) Tractel T-532 Griphoist with 30' of 5/8" wire rope, (3) .218-.55" Klein Grips, (3) .50-.75" Klein Grips, (3) .75-1.00" Klein Grips, (3) 6' LiftAll red round slings, (3) 3/4" Crosby screw pin anchor shackles, (3) 7/8" Crosby screw pin anchor shackles, DET-2 Theodolite, 90° eyepiece for DET-2, Johnson Level heavy duty aluminum tripod, Dillon Quick Tension Meter, Sheave Kit up to 1/2", Sheave Kit 1/2" - 1", carry case for Tension Meter, (10) Dillon calibrations.

GUYKIT - \$14,499.99



GME SUPPLY HEAVY DUTY SHACKLE PACK

Includes (2) Crosby 1" galvanized screw pin shackles, (2) Crosby 7/8" galvanized screw pin shackles, and (4) Crosby 3/4" galvanized screw pin shackles. These shackles are forged - quenched and tempered, with alloy pins. Approved for use at -40° F to 400° F. Meets or exceeds all requirements of ASME B30.26. Statistical proof and impact tested. Proof testing and certification available upon request.

SHACKLEPACKHD - \$289.00

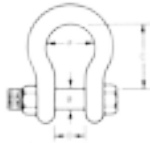

SCREW TYPE SAFETY SHACKLES

SIZE (A)	WLL	PIN (B)	(C)	(D)	(E)	(F)	MADE IN USA		MADE IN USA		IMPORTED	
							GALVANIZED G-209 PART	USA	SELF-COLORED S-209 PART	USA	GALVANIZED PART	IMPORTED
3/8"	1 ton	7/16"	1.44"	.63"	.91"	1.00"	1018419	\$9.45	1018428	\$9.17	SHA38LR	\$3.15
1/2"	2 tons	5/8"	1.88"	.81"	1.31"	1.25"	1018455	\$12.79	1018464	\$12.24	SHA12LR	\$6.15
5/8"	3-1/4 tons	3/4"	2.44"	1.06"	1.56"	1.69"	1018473	\$23.87	1018482	\$21.95	SHA58LR	\$9.99
3/4"	4-3/4 tons	7/8"	2.88"	1.19"	1.88"	1.94"	1018491	\$34.30	1018507	\$31.50	SHA34LR	\$15.75
7/8"	6-1/2 tons	1"	3.38"	1.44"	2.13"	2.19"	1018516	\$47.45	1018525	\$42.70	SHA78LR	\$19.75
1"	8-1/2 tons	1-1/8"	3.81"	1.69"	2.38"	2.63"	1018534	\$64.00	1018543	\$56.20	SHA1LR	\$29.15
1-1/8"	9-1/2 tons	1-1/4"	4.25"	1.75"	2.63"	2.88"	1018552	\$92.90	1018561	\$84.60	SHA118LR	\$33.15
1-1/4"	13-1/2 tons	1-3/8"	4.69"	2.00"	3.00"	3.13"	1018570	\$133.50	1018589	\$121.80	SHA114LR	\$56.99



G-209



S-209



G-2130



S-2130

BOLT TYPE SAFETY SHACKLES

SIZE (A)	WLL	PIN (B)	(C)	(D)	(E)	(F)	MADE IN USA		MADE IN USA		IMPORTED	
							GALVANIZED G-2130 PART	USA	SELF-COLORED S-2130 PART	USA	GALVANIZED PART	IMPORTED
3/8"	1 ton	7/16"	1.44"	.63"	.91"	1.00"	1019470	\$14.74	-	-	SHA38LRBT	\$3.15
1/2"	2 tons	5/8"	1.88"	.81"	1.31"	1.25"	1019472	\$26.00	1019481	\$24.79	SHA12LRBT	\$6.15
5/8"	3-1/4 tons	3/4"	2.44"	1.06"	1.56"	1.69"	1019490	\$36.85	1019506	\$31.30	SHA58LRBT	\$9.99
3/4"	4-3/4 tons	7/8"	2.88"	1.19"	1.88"	1.94"	1019515	\$53.30	1019524	\$47.95	SHA34LRBT	\$15.74
7/8"	6-1/2 tons	1"	3.38"	1.44"	2.13"	2.19"	1019533	\$74.40	1019542	\$66.10	SHA78LRBT	\$19.75
1"	8-1/2 tons	1-1/8"	3.81"	1.69"	2.38"	2.63"	1019551	\$100.30	1019560	\$88.00	SHA1LRBT	\$29.15
1-1/8"	9-1/2 tons	1-1/4"	4.25"	1.75"	2.63"	2.88"	1019579	\$130.80	1019588	\$117.50	SHA118LRBT	\$33.59
1-1/4"	12 tons	1-3/8"	4.69"	2.00"	3.00"	3.13"	1019597	\$177.40	1019604	\$161.40	SHA114LRBT	\$51.99



HARRINGTON
HOISTS AND CRANES

HARRINGTON LB MINI LEVER HOISTS

Harrington's LB lever hoists combine easy operation with a compact, low headroom design that easily handles real-world demands. Rated #1 selling lever hoist in the U.S., these hoists can be used horizontally, vertically, inverted, or at any other direction. Perfect for use in heavy-duty tower construction and maintenance, manufacturing, and day-to-day maintenance and repair. Rugged, all-steel construction; includes two brake pawls for additional reliability; moisture resistant break pads; patented spring-loaded freewheel mechanism permits easy adjustment of the load chain and safeguards against accidental freewheeling under load; equipped with standard rubber grip for non-slip operation. Other capacities and lift heights available.

PART	CAPACITY	LIFT HEIGHT	HEAD ROOM	PULL TO LIFT LOAD*	NET WEIGHT	PRICE
LB008-10	3/4 tons	10	11 in	54 (36) lbs	13 lbs	\$496.00
LB008-15	3/4 tons	15	11 in	54 (36) lbs	13 lbs	\$548.60
LB008-20	3/4 tons	20	11 in	54 (36) lbs	13 lbs	\$604.60
LB015-10	1-1/2 tons	10	13.2 in	64 (45) lbs	18 lbs	\$675.00
LB015-15	1-1/2 tons	15	13.2 in	64 (45) lbs	18 lbs	\$742.50
LB015-20	1-1/2 tons	20	13.2 in	64 (45) lbs	18 lbs	\$788.50
LB030-10	3 tons	10	15.6 in	69 lbs	57 lbs	\$892.99
LB030-20	3 tons	20	15.6 in	69 lbs	57 lbs	\$1,057.80
LB060-10	6 tons	10	21.3 in	78 lbs	88 lbs	\$1,692.90

*Figures in parentheses are for hoists with the optional load limit warning handle



HARRINGTON LX MINI LEVER HOISTS

Harrington's LX lever pullers are ultra lightweight and compact yet extremely durable; Perfect toolbox hoists. Compact, low headroom design makes it ideal for use in tight quarters. Low pulling force required for ease of use. Rugged die-cast aluminum body with steel frame; grade 100, nickel-plated load chain is corrosion and wear resistant. Strong hook latches including notched tip.

PART	CAPACITY	HEAD ROOM	LIFT	WEIGHT	PRICE
LX003-5	1/4 tons	8.1 in	40 lbs	4 lbs	\$215.00
LX003-10	1/4 tons	8.1 in	40 lbs	9 lbs	\$234.10
LX005-5	1/2 tons	9.7 in	62 lbs	6.2 lbs	\$302.00
LX005-10	1/2 tons	9.7 in	62 lbs	11.2 lbs	\$321.70



HARRINGTON CX MINI HAND CHAIN HOIST

Harrington's CX mini hand chain hoist is uniquely compact and lightweight. Perfect choice for jobs with light loads in high or difficult to reach places. Aluminum body with steel frame provides superior strength. Very low force is required to lift load. Grade 100 nickel-plated load chain is corrosion and wear resistant. Durable stainless steel hand chain. Strong hook latches include safety tip.

PART	CAPACITY	HEAD ROOM	LIFT	WEIGHT	PRICE
CX003-10	1/4 tons	8.5 in	33 lbs	6.1 lbs	\$348.00
CX003-20	1/4 tons	8.5 in	33 lbs	10 lbs	\$641.00
CX005-10	1/2 tons	10.2 in	40 lbs	10.6 lbs	\$459.00
CX005-20	1/2 tons	10.2 in	40 lbs	16.4 lbs	\$758.00



HARRINGTON CF HAND CHAIN HOIST

Harrington's CF hand chain hoist provides a practical alternative thanks to an economical design using fewer parts for trouble free service. Outstanding durability is due to a die-cast aluminum body and high-strength, heat treated main pinion shaft and load gear. Pre-lubricated ball bearings, precision machined gears, and Weston-style load brake make lifting smooth and easy while allowing long service and low maintenance.

PART	CAPACITY	HEAD ROOM	LIFT	WEIGHT	PRICE
CF005-10	1/2 tons	12.8 in	60 lbs	24 lbs	\$272.00
CF005-20	1/2 tons	12.8 in	60 lbs	34 lbs	\$422.00
CF010-10	1 tons	14.6 in	72 lbs	32 lbs	\$321.00
CF010-20	1 tons	14.6 in	72 lbs	44 lbs	\$475.00
CF015-10	1-1/2 tons	17.3 in	84 lbs	40 lbs	\$467.00
CF015-20	1-1/2 tons	17.3 in	84 lbs	54 lbs	\$659.00
CF020-10	2 tons	20.1 in	80 lbs	45 lbs	\$534.00
CF020-20	2 tons	20.1 in	80 lbs	63 lbs	\$751.00
CF030-10	3 tons	23.2 in	92 lbs	60 lbs	\$805.00
CF030-20	3 tons	23.2 in	92 lbs	82 lbs	\$1,102.00



HARRINGTON PT MANUAL TROLLEY

Versatile, durable, and economical push trolley. Maintenance-free sealed ball bearings provide smooth operation. Assist in maneuvering loads easily. High strength and rigidity from a lightweight, compact design. Easily adjust trolley to fit a wide variety of beam flange widths. Load equalizing suspension distributes the load to all wheels. Wide standard flange ranges reduce the need for optional extended shaft kits.



PART	CAPACITY	WEIGHT	PRICE
PT005	1/2 tons	9 lbs	\$168.00
PT010	1 tons	15 lbs	\$224.00
PT020	2 tons	29 lbs	\$320.00
PT030	3 tons	46 lbs	\$490.00
PT050	5 tons	95 lbs	\$812.00
PT080	8 tons	212 lbs	\$2,152.00



JET JLP LEVER HOISTS

PART	CAPACITY	LIFT	WEIGHT	PRICE
287301	3/4 ton	10'	17 lbs	\$259.00
287302	3/4 ton	15'	19 lbs	\$274.00
287303	3/4 ton	20'	22 lbs	\$289.00
287401	1-1/2 tons	10'	30 lbs	\$319.00
287402	1-1/2 tons	15'	34 lbs	\$349.00
287403	1-1/2 tons	20'	39 lbs	\$369.00
287500	3 tons	5'	43 lbs	\$449.00
287501	3 tons	10'	50 lbs	\$484.00
287502	3 tons	15'	57 lbs	\$539.00
287601	6 tons	10'	76 lbs	\$779.00
287603	6 tons	20'	91 lbs	\$909.00



JET JLH LEVER HOISTS

PART	CAPACITY	LIFT	WEIGHT	PRICE
376101	3/4 ton	10'	15 lbs	\$320.00
376102	3/4 ton	15'	17 lbs	\$359.00
376103	3/4 ton	20'	19.5 lbs	\$389.00
376201	1 ton	10'	15.25 lbs	\$334.00
376301	1-1/2 tons	10'	21.25 lbs	\$399.00
376302	1-1/2 tons	15'	25 lbs	\$424.00
376303	1-1/2 tons	20'	28.5 lbs	\$474.00
376501	3 tons	10'	37.5 lbs	\$624.00
376503	3 tons	20'	53 lbs	\$729.00
376601	6 tons	10'	72 lbs	\$984.00



JET JLH COMPACT LEVER HOISTS

PART	CAPACITY	LIFT	WEIGHT	PRICE
181205	1/4 ton	5'	3.5 lbs	\$189.00
181210	1/4 ton	10'	4.2 lbs	\$209.00
181215	1/4 ton	15'	5.25 lbs	\$229.00
181505	1/2 ton	5'	5.5 lbs	\$259.00
181510	1/2 ton	10'	7 lbs	\$289.00
181515	1/2 ton	15'	8.6 lbs	\$319.00



TRACTEL BLOCSTOP BSO

Monitors the speed of the load. Stops the downward movement of the load lifting equipment if sudden acceleration occurs.

PART	CAPACITY	WIRE ROPE	PRICE
3229K	1,500	5/16"	\$470.50
3129K	3,000	7/16"	\$556.70
3149K	6,600	5/8"	\$830.10



TRACTEL GRIPHOIST / TIRFOR WIRE ROPE HOISTS

PART	CAPACITY	WIRE ROPE	WEIGHT	PRICE
T 508D	2,000	30' of 5/16"	23 lbs	\$1,209.99
T 516D	4,000	60' of 7/16"	48 lbs	\$1,385.99
T 532D	8,000	30' of 5/8"	61 lbs	\$2,363.99



KLEIN TOOLS PARALLEL JAW GRIPS

Round inside-jaw contour for maximum contact to minimize cable deformation, lower jaw is serrated to firmly grip insulated cables and conductors, includes a latch that prevents the grip from falling, large diameter eye.

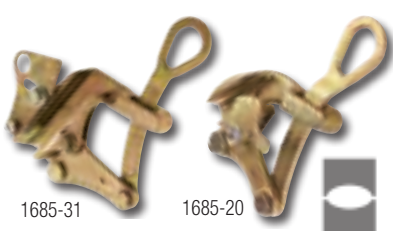

PART	MIN - MAX CABLE DIAMETER	MAX LOAD	WEIGHT	PRICE
1685-20	.157" - .875" (4 mm - 22 mm)	4,500 lbs	3 lbs	\$226.99
1685-31	.625 - 1.250" (16 mm - 32 mm)	7,500 lbs	5 lbs	\$292.99

KLEIN TOOLS WIRE ROPE HAVEN'S GRIPS

Designed for use when light, compact grip is desired and where cable deformation is not a factor, gripping pressure of the knurled jaw is applied to 1/4" (6.35 mm) cable area, all 1625 series have a swing latch to help hold cable in the jaw.



PART	MIN - MAX CABLE DIAMETER	MAX LOAD	WEIGHT	PRICE
1625-20	.28" - .75" (7.11 mm - 19.05 mm)	8,000 lbs	4 lbs	\$133.99
1625-20 7/8	.38" - .88" (9.65 mm - 22.35 mm)	8,000 lbs	4 lbs	\$154.99
1625-20 1	.50" - 1.00" (12.70 mm - 25.40 mm)	8,000 lbs	4 lbs	\$173.99

KLEIN TOOLS AIRCRAFT CABLE, MESSENGER, & GUY STRAND CHICAGO GRIPS

Double V grooves provide four-point contact, reducing chance of slipping and providing proper alignment of wire and cable (1684-5F is a Single V with file insert).

PART	HOT LATCH	SPRING	MIN - MAX CABLE DIAMETER	MAX SAFE LOAD	JAW LENGTH	WEIGHT	PRICE
1613-40	1613-40H	S1613-40H	.12" - .37" (3.05 mm - 9.40 mm)	4,500 lbs	4-3/16" (106 mm)	3 lbs	\$149.99
1684-5F	N/A	N/A	.16" - .550" (4.06 mm - 13.97 mm)	8,000 lbs	5" (127 mm)	6.25 lbs	\$448.99
1684-5	1684-5H	S1684-5H	.218" - .550" (5.54 mm - 13.97 mm)	8,000 lbs	5" (127 mm)	6.25 lbs	\$257.99
1692-5	N/A	N/A	.218" - .550" (5.54 mm - 13.97 mm)	8,000 lbs	5" (127 mm)	6.40 lbs	\$256.99
1684-74	N/A	S1684-74H	.218" - .550" (5.54 mm - 13.97 mm)	8,000 lbs	5" (127 mm)	6.30 lbs	\$259.99
1628-16	N/A	N/A	.31" - .62" (7.87 mm - 15.75 mm)	15,000 lbs	7-1/4" (184 mm)	15.30 lbs	\$504.99
1628-17	N/A	N/A	.50" - .75" (12.70 mm - 19.05 mm)	15,000 lbs	7-1/4" (184 mm)	16.30 lbs	\$641.99
1628-18	N/A	N/A	.75" - 1.00" (19.05 mm - 25.40 mm)	15,000 lbs	7-1/4" (184 mm)	15.70 lbs	\$643.99

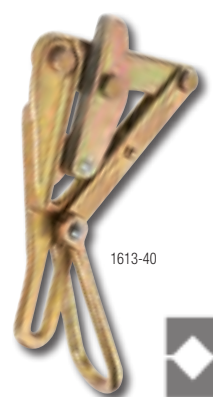

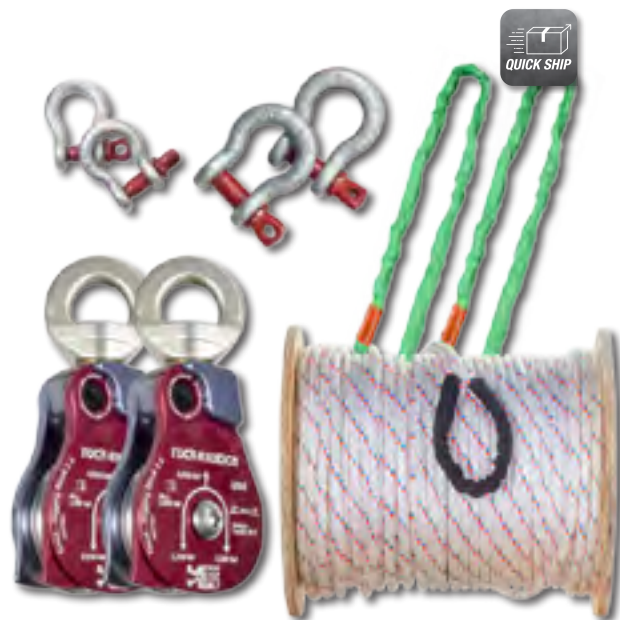

GME SUPPLY RIG KIT

Save time and money with our rig kit. This rigging kit includes everything extra you need with capstan lifting and rigging applications. Kit includes (2) 3' LiftAll ENR3 Endless Round Slings, (1) 1/2" WestFall Pro Load Line (choose length), (2) Rock Exotica MHP55 Material Handling Blocks, (2) 1/2" and (2) 5/8" Crosby Galvanized Screw Pin Shackles.

RIGKIT3 300' Rope, Rock Exotica blocks - \$677.99

RIGKIT6 600' Rope, Rock Exotica blocks - \$867.99

RIGKIT12 1,200' Rope, Rock Exotica blocks - \$1,217.99

RIGKIT3-CY 300' Rope, Crosby McKissick blocks - \$727.99

RIGKIT6-CY 600' Rope, Crosby McKissick blocks - \$917.99

RIGKIT12-CY 1,200' Rope, Crosby McKissick blocks - \$1,267.99

GME SUPPLY RIG KIT XL

Save time and money with our extra large rig kit. This rigging kit includes everything extra you need with capstan lifting and rigging applications. Kit includes (2) 3' LiftAll ENR2 Endless Round Slings, (1) 5/8" WestFall Pro Load Line (choose length), (2) Crosby McKissick 4.5" Block for 5/8" rope, (2) 1/2" and (2) 5/8" Crosby Galvanized Screw Pin Shackles.

RIGKIT3-XL 300' - \$1,167.99

RIGKIT6-XL 600' - \$1,467.99

RIGKIT12-XL 1,200' - \$1,967.99

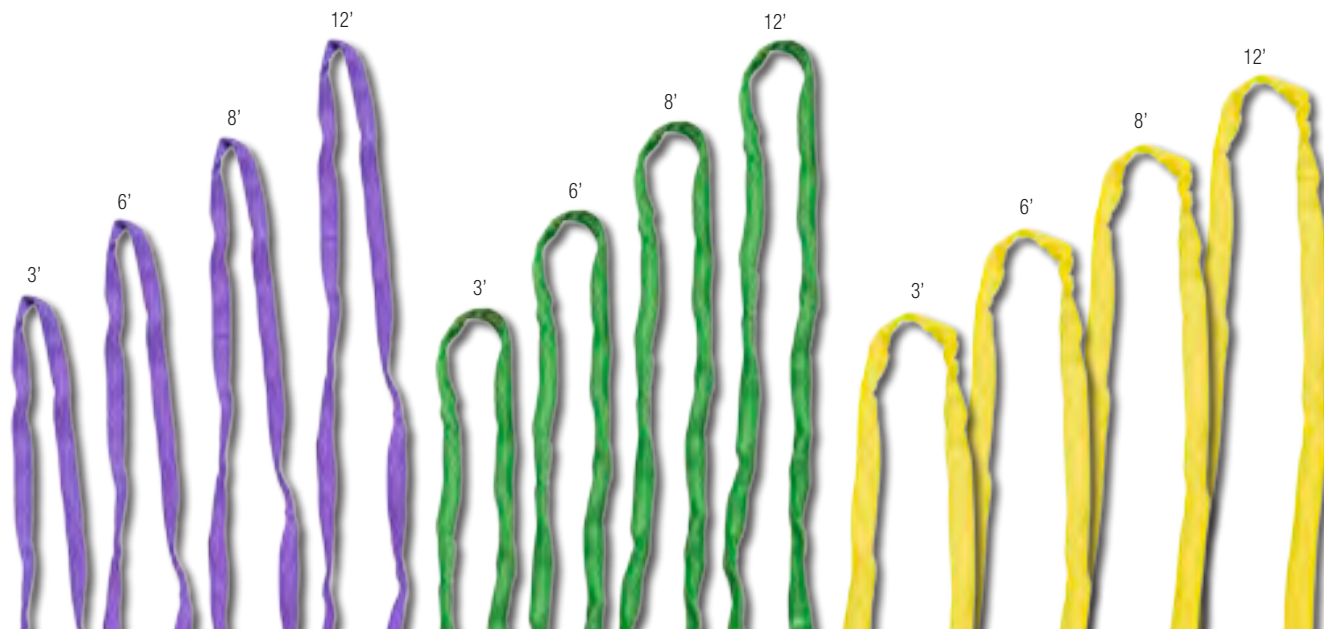

GME SUPPLY PURPLE SLING PACK

Includes (2) 3' LiftAll ENR1 Purple Round slings, (2) 6' LiftAll ENR1 Purple Round slings, (2) 8' LiftAll ENR1 Purple Round slings, and (2) 12' LiftAll ENR1 Purple Round slings.

GM-PURPLESLINGPACK - \$143.99

GME SUPPLY GREEN SLING PACK

Includes (2) 3' LiftAll ENR2 Green Round slings, (2) 6' LiftAll ENR2 Green Round slings, (2) 8' LiftAll ENR2 Green Round slings, and (2) 12' LiftAll ENR2 Green Round slings.

GM-GREENSLINGPACK - \$159.99

GME SUPPLY YELLOW SLING PACK

Includes (2) 3' LiftAll ENR3 Yellow Round slings, (2) 6' LiftAll ENR3 Yellow Round slings, (2) 8' LiftAll ENR3 Yellow Round slings, and (2) 12' LiftAll ENR3 Yellow Round slings.

GM-YELLOWSLINGPACK - \$209.99





LIFTALL ENDLESS ROUND SLING

Continuous loop of 100% polyester fiber, double polyester woven jacket to protect the load-bearing fibers from damage. Each sling has a tough, resilient tag for quick and easy identification. Base prices are for 3' slings, longer lengths available.



PART	WIDTH	COLOR	VERTICAL	CHOKER	BASKET	PRICE	+/FT
ENR1	5/8"	Purple	2,600 lbs	2,100 lbs	5,200 lbs	\$9.45	\$2.00
ENR2	7/8"	Green	5,300 lbs	4,200 lbs	10,600 lbs	\$11.25	\$2.55
ENR3	1-1/8"	Yellow	8,400 lbs	6,700 lbs	16,800 lbs	\$14.99	\$3.45
ENR4	1-1/8"	Tan	10,600 lbs	8,500 lbs	21,200 lbs	\$18.65	\$4.00
ENR5	1-3/8"	Red	13,200 lbs	10,600 lbs	26,400 lbs	\$21.99	\$5.30
ENR6	1-3/8"	White	16,800 lbs	13,400 lbs	33,600 lbs	\$23.99	\$6.10
ENR7	1-3/4"	Blue	21,200 lbs	17,000 lbs	42,400 lbs	\$33.99	\$7.65
ENR8	2-1/4"	Gray	31,000 lbs	24,800 lbs	62,000 lbs	\$74.99	\$11.55



POLYESTER EYE & EYE WEB SLING



PART	PLY	WIDTH	VERTICAL	CHOKER	BASKET	MIN. LENGTH	PRICE	+/FT
EE1-91P	1	1"	1,600 lbs	1,280 lbs	3,200 lbs	3'	\$4.50	\$0.35
EE1-92P	1	2"	3,200 lbs	2,500 lbs	6,400 lbs	4'	\$8.33	\$0.60
EE1-93P	1	3"	4,800 lbs	3,800 lbs	9,600 lbs	4'	\$13.35	\$1.00
EE1-94P	1	4"	6,400 lbs	5,000 lbs	12,800 lbs	4'	\$17.75	\$1.20
EE2-91P	2	1"	3,200 lbs	2,500 lbs	6,400 lbs	3'	\$6.25	\$0.75
EE2-92P	2	2"	6,400 lbs	5,000 lbs	12,800 lbs	3'	\$9.99	\$1.25
EE2-93P	2	3"	8,800 lbs	7,040 lbs	18,600 lbs	4'	\$18.05	\$2.00
EE2-94P	2	4"	11,500 lbs	9,200 lbs	23,000 lbs	3'	\$24.65	\$3.75



WIRE ROPE SLING



PART	WIDTH	VERTICAL	CHOKER	BASKET	EYE SIZE	MIN. LENGTH	PRICE	+/FT
MS14	1/4"	.65 tons	.48 tons	1.3 tons	2" x 4"	1'6"	\$11.29	\$1.00
MS516	5/16"	1 tons	.74 tons	2.0 tons	2.5" x 5"	1'9"	\$14.97	\$1.50
MS38	3/8"	1.4 tons	1.1 tons	2.9 tons	3" x 6"	2'	\$16.79	\$1.75
MS716	7/16"	1.9 tons	1.4 tons	3.9 tons	3.5" x 7"	2'3"	\$18.15	\$1.75
MS12	1/2"	2.5 tons	1.9 tons	5.1 tons	4" x 8"	2'6"	\$19.69	\$2.00
MS916	9/16"	3.2 tons	2.4 tons	6.4 tons	4.5" x 9"	2'9"	\$23.65	\$2.25
MS1	1"	9.8 tons	7.2 tons	20.0 tons	8" x 16"	4'6"	\$70.89	\$5.50



YELLOW NYLON TUBULAR QUICK SLEEVE

These heavy polyester sling covers have velcro closures for quick and easy protection of round slings and/or load from damage. Call our Gear Experts® for pricing on other materials.

PART	WIDTH	FITS RS SIZE	PRICE/FT
QSR2HP	6"	ENR1 - ENR2	\$12.99
QSR5HP	8"	ENR3 - ENR5	\$17.99
QSR7HP	10"	ENR6 - ENR7	\$21.99
QSR9HP	12"	ENR8 - ENR9	\$23.99
QSR11HP	14"	ENR10 - ENR11	\$34.99
QSR13HP	16"	ENR12 - ENR13	\$38.99

3" POLYESTER ENDLESS WEB SLINGS



PART	PLY	WIDTH	VERTICAL	CHOKER	BASKET	MIN. LENGTH	PRICE	+/FT
EN1-91P	1	1"	3,200 lbs	2,500 lbs	6,400 lbs	3'	\$5.99	\$0.75
EN1-92P	1	2"	6,400 lbs	5,000 lbs	12,800 lbs	3'	\$8.25	\$1.25
EN1-93P	1	3"	8,800 lbs	7,040 lbs	17,600 lbs	3'	\$11.99	\$2.00
EN1-94P	1	4"	11,500 lbs	9,200 lbs	23,000 lbs	3'	\$13.99	\$2.50
EN2-91P	2	1"	6,200 lbs	4,900 lbs	12,400 lbs	3'	\$9.89	\$1.50
EN2-92P	2	2"	12,400 lbs	9,900 lbs	24,800 lbs	3'	\$15.25	\$2.50
EN2-93P	2	3"	16,300 lbs	13,000 lbs	32,600 lbs	3'	\$22.50	\$4.25
EN2-94P	2	4"	20,700 lbs	16,500 lbs	41,400 lbs	3'	\$26.50	\$5.25



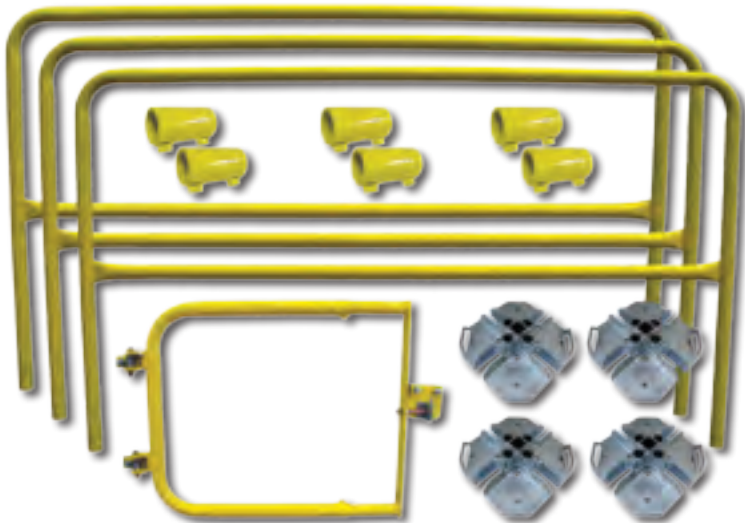

DBI SALA PORTABLE GUARDRAIL ROOF HATCH KIT

Powder coated, (4) guardrail bases #7900060, (3) 6' guardrail sections #7900061, (3) rail splice kits to customize length, swing gate #7900007, free-standing guardrail system doesn't require attachment to surface, simple set-screw design, compact and lightweight design, various lengths and individual components are available.

7900008 Kit - \$1,869.99

7900060 Portable guardrail base - \$279.99

7900061 Portable guardrail, 6' section - \$164.99

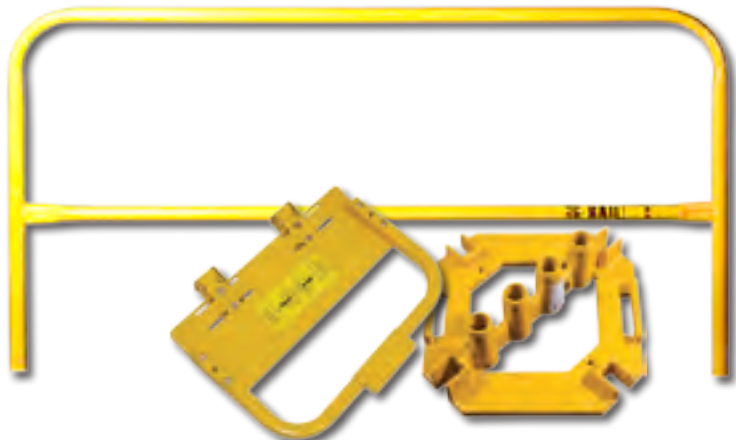

GUARDIAN GUARDRAIL

Part of the ultimate free-standing fall prevention system, block workers from exposure to fall hazards, made from powder-coated steel for supreme durability and weather resistance, compatible with both the multi-directional base plate and standard base plate options, meets all applicable OSHA & ANSI standards, powder coated safety yellow.

15183 42" x 6' - \$133.99

15182 42" x 8' - \$184.99

15181 42" x 10' - \$195.99

15178 Multi-directional guardrail base - \$256.99

15105 Guardrail safety swing gate - \$153.99



GUARDIAN REPLACEMENT FLAG LINE

Made from 100' of heavy-duty nylon cording and heat sealed flags. Flags spaced two feet apart for extra visibility. Compliant with Guardian Goose and Single Stanchions, Permanent Warning Line Masts, and can be used as a component of an OSHA compliant warning line system.

15231 - \$20.99

C-SLAB GRABBER

Perfect solution for installing guardrail systems on concrete decking; Includes an anti-slip grip, quick adjust handle, and back-up safety pin that functions to ensure complete system integrity; Meets or exceeds compliance with OSHA regulations; Easy to install and adjust to fit concrete slabs up to 36" thick; Compatible with 2 x 4" and 2 x 6" boards; Powder coated steel is resistant to corrosion and damage.

15500 - \$57.99



LAKESIDE PLASTICS PERIMETER DEFENDER

30 lbs base weight, 30" L, 14" H base. Easy flag tie-off system, quick set-up and removal, stores easily, (2) mounting holes for warning lights or signs, UV resistant safety orange, non-conductive, 39" OSHA compliant tie off height 1926.502(f)(2)(ii), high-impact polyethylene, skid resistant, will not leave rust marks on roofs, rubber base will not damage surfaces, stackable with or without base, large grip handle for ease of transporting and handling, base made of 100% recycled rubber.

39-XXXXXX-R30 - \$49.99



GUARDIAN SINGLE STANCHION

Specially designed for use with a reusable warning line, block worker from exposure to fall hazards, weighs only 23 lbs, 39" tall, easy to install and store, convenient handle facilitates simple transportation, maximum spacing 50' apart.

15225 Powder coated steel - \$182.99

15227 Aluminum - \$119.99

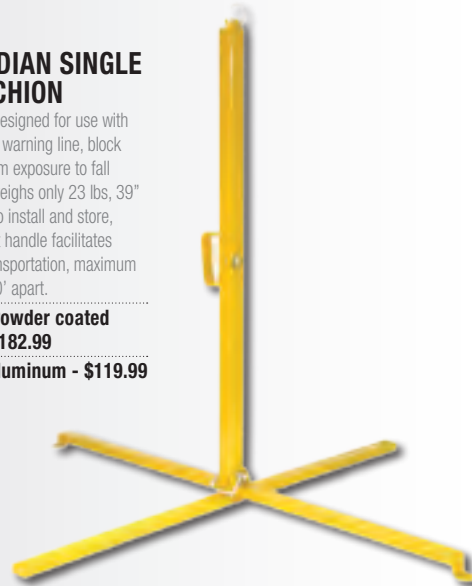



GUARDIAN ROOFER KIT

Incorporates an integrated shock absorber into the lifeline. User will never have to worry about adding a shock absorbing lanyard to his fall protection system. By removing the shock pack from the worker's back less dead weight is transferred to the dorsal D-ring. Comes in a variety of configurations. Includes temper reusable roof anchor #00455 and VLA-50' #01320. ANSI compliant.

00815 - \$115.99



GUARDIAN LITTLE BUCKET OF SAFE-TIE

OSHA and ANSI compliant roofing kit built for roofers. Includes harness, 6' single leg lanyard with shock pack, nylon bag for equipment transport and storage. Perfect for storage and daily transport. Durable and convenient.

00870 - \$82.99



PROTECTA ROOFER COMPLIANCE IN A CAN

Includes reusable roof anchor, 5-point harness, rope grab, and 50' lifeline. Improved fit, updated colors, and durable yet lightweight construction. Provides greater comfort and added safety which translates to reduced worker fatigue and increased productivity. 3,600 lbs gated hooks. Meets ANSI Z359.

2199803 - \$150.51



PROTECTA COMPLIANCE IN A CAN LIGHT ROOFER'S FALL PROTECTION KIT

Complete all purpose fall protection system in one handy container. Lightweight First Harness with pass-thru buckle legs and 5-point adjustment. Pro 6' single-leg shock absorbing lanyard. Durable bucket with handle. Meets OSHA 1910.66 and OSHA 1926.502.

2199802 - \$73.99



PROTECTA COMPLIANCE IN A CAN LIGHT ROOFER'S FALL PROTECTION KIT WITH TIE-OFF ADAPTER

This fall protection kits combines all the roofing gear you need so stay compliant into one convenient container. Complete all purpose fall protection system in one handy container. Lightweight First Harness with pass-thru buckle legs and 5-point adjustment. Compact Pro-Stop 6' single-leg shock absorbing lanyard. 6' pass-thru type tie-off adaptor. Durable bucket with handle.

2199810 - \$108.99



**DBI SALA
ADJUSTABLE
ROPE POSITIONING
LANYARD**

Abrasion resistant sleeve helps prolong product life, blue wear indicating core signals when product needs to be taken out of service, 2.2 lbs, 8' length.

1234070 - \$249.99



**DBI SALA
CYNCH-LOK FALL
RESTRICTING
POLE STRAP**

Pinch free, ergonomic grips. Abrasion resistant rope guard. Stopping cleat and carabiner. Specially designed and uniquely cleated plate and carabiner help restrict a fall during a cut-out by gripping the pole when the strap itself "cinches".

1204075 Web distribution, pole size DIA: 5.5"/17.5"-18.5"/58", 4.9 lbs - \$569.99

1204076 Web transmission, pole size DIA: 5.5"/17.5"- 30.5"/96", 5.4 lbs - \$624.99



**BUCKINGHAM
SUPERSQUEEZE
WITH WOVEN
INNER STRAP**

Easy one handed outer strap adjustment, outer strap measures 36" and woven inner strap with carabiners measures 48", meets ASTM F887-11, and rated to 350 lbs.

488W2 - \$613.99



NEW



GME SUPPLY LINEMAN KIT

Lineman kit includes full floating body belt 40"-48", Hydra-Cool climber pads, snap-on gaff guard, lineman backpack orange, 5-pocket tool pouch canvas, extra-large canvas utility bag.

90060 - \$814.99



DBI SALA CYNCH-LOK FALL RESTRICTING POLE STRAP

Allows user to easily hitch-hike poles and move past obstacles, interchangeable exterior straps, pinch free, ergonomic grips, abrasion resistant rope guard, stopping cleat and carabiner restrict a fall during a cut-out, distribution model, pole size (dia/circ): 5.5"/17.5"- 18.5"/58", 4.8 lbs.

1204057 - \$599.99

1204058 Transmission model, pole size (dia/circ): 5.5"/17.5"- 30.5"/96", 5.3 lbs - \$629.99

**KLEIN TOOLS
DELUXE FULL-
FLOATING
BODY BELT**

Forged D-rings have corrosion-resistant finish, full-floating web strap, padded for maximum comfort, latigo-leather belt pad. Available in sizes 18 D - 30 D.

5278N - \$299.99



**DBI SALA
ARC FLASH
NANO-LOK**

Arc flash rated; built-in connector for single-leg SRL direct attachment to harness; 8' of 3/4" Kevlar fiber webbing lifeline; self-locking snaphook on lifeline; tough and impact resistant thermoplastic housing; swiveling anchorage loop, wide variety of configurations available.

3101527 - \$289.99



**KLEIN TOOLS
GENERAL
PURPOSE
INSULATED
TOOL KIT**

(2) layers of insulation provide protection against electric shock, comprehensive assortment of (22) insulated tools, piano-hinged cover has both a combination lock and two key-locked latches for security.

33527 - \$1,187.83





PETZL SHOULDER STRAPS FOR SEQUOIA SRT HARNESS

0.7 lbs. Shoulder straps for Sequoia SRT seat harness designed for taking the load from the waist belt and redistributing it to the shoulders for improved comfort. These straps connect to the ventral attachment point of the harness and to the two slots at the rear of the waist belt.

C69B - \$69.95



PETZL SEQUOIA SRT ARBORIST SEAT HARNESS

3.7 lbs. Harness designed for ascents on single rope, extra-wide semi-rigid waist belt and leg loops give excellent support, attachment bridge is linked to (2) gated rings for length adjustment, facilitates carrying and organization of tools with multiple equipment loops and slot for attaching caritool tool holders.

C69BFA - \$449.95



PETZL AVAO SIT FAST ARBORIST SEAT HARNESS

3.2 lbs. Harness designed for positioning and suspension, wide semi-rigid waist belt and leg loops give excellent support and allows for easy adjustment, facilitates carrying and organization of tools with multiple equipment loops and slot for attaching caritool tool holders.

C79AFA - \$299.95



SKYLOTEC RECORD ARBORIST HARNESS

1.8 lbs. Harness offers comfort and flexibility with its extremely lightweight design. The built in cooling fins and breathable mesh ensure air circulation during long hours of wear. The waist belt and leg loops have a double layer of padding for extra comfort. Harness can easily be attached to different Skylotec harness top parts to switch between applications.

G-1110 - \$327.99



ISC TRIPLE ACTION SWIVEL SNAPHOOK

World's first triple action snaphook with swivel eye. Design features include safety heel to prevent accidental opening. "Blind" nose to reduce snagging. 27 kN MBS.

SH905 - \$43.25



ISC TRIPLE ACTION SNAPHOOK

Fitted with third action catch for increased safety. Triple-action hook is ideal for adjustable lanyards and flip lines. Safety heel reduces risk of accidental opening. "Blind" nose helps prevent rope snagging. 27 kN MBS.

SH903 - \$29.87



ISC SMALL DOUBLE PRUSIK BLOCK

1/2" (13 mm) rope diameter. 40 kN MBS. Tamper-proof rivets, available in aluminum and stainless steel with bushings or roller bearings. Fully load-rated beckets. Large enough to allow a carabiner to rotate fully.

RP061 - \$60.42



CLIMBING TECHNOLOGY SHELTER EVO SNAPHOOK

Double gate connector, easy handling even when wearing gloves. Shaped to protect levers in case of impact. Compact size is easy to carry.

2C37000WVA - \$17.00



ROCK EXOTICA NANO SWIVEL

Weighing only 2 oz, the Rock Exotica Nano Swivel is very light. Features an integrated rubber O-ring that helps hold it in place when connected to carabiners. MBS: 23 kN, Working Load: 2 kN.

S11 - \$70.00



PETZL MICRO SWIVEL

The compact, openable micro swivel is designed for attachment to a locking carabiner. It helps prevent twisting of lanyards and allows correct positioning of devices. Its design without bearings allows it to turn freely when not loaded and to stop moving when loaded in order to maintain the devices in position.

P58 XS0 - \$49.95



CLIMBING TECHNOLOGY QUICK'ARBOR H ASCENDER

3/8" - 1/2" (10 - 13 mm) rope diameter. Ergonomic, comfortable and innovative. Features protective cam covers to prevent vegetation from becoming jammed. "V" angle of handles creates the most comfortable ascent possible. Non-slip handles allow for use while wearing gloves. Multiple attachment points on base.
2D653 - \$175.00



KLEIN TOOLS TREE CLIMBERS GAFFS WITH PADS & STRAPS

15"-19" long, 8" x 8" cushioned, high-grade leather climber pads for maximum comfort. Neoprene-impregnated nylon climber straps for long-lasting life. Secure sleeve and leg iron connection. Steel split ring secures ankle strap in place and allows for quick replacement.
52022 - \$321.99



ISC STRYDER FOOT ASCENDER

Provides smooth movement and positive engagement on the rope. Stainless steel coned cam-face allows positive engagement on the rope for a firm reliable grip, with minimal wear to the sheath. Foot-lever can be used to open / close the cam with the other foot. Fully adjustable on both the horizontal and vertical straps.
RP227 - \$70.00



ISC ROCKER ROPE GRAB

Can be fitted to rope at any point, can be used hands free when traveling up and down rope. Designed for use without shock absorber. Can also be used as a rope adjuster on positioning lanyard or flip-line. Thumb-catch allows device to be parked. Non-aggressive rope-friendly cam faces. Aluminum construction.
RP500 - \$149.99



PETZL ZIGZAG TREE ROPE WRENCH ZK-2

Mechanical prusik allows the user to move around efficiently in a tree using classic prusik pulley system technique. The linked rings provide precision and fluidity when moving around. Pulley is mounted on sealed ball bearings to allow the slack to be taken up easily. Steel construction offers great durability.
D22A - \$279.95



SINGING TREE ROPE WRENCH

Made from aluminum. Used to create a 'bend' in the rope, above the climber's hitch. With the addition of a stiff tether, it created a contained double rope system on a single line of rope. This contained double rope system travels with the climber as they move around the tree, allowing a consistent level of friction on the hitch, which is impossible to achieve in double rope climbing.
RP280A1 + 8351ST2 - \$128.66



30" ARMOR 8 MM EYE AND EYE

Best suited to 11 mm and 11.7 mm climbing lines. Blended Technora cover to prevent melting and glazing, over a core of lightweight Spectra 900. Very low stretch. Technora is rated to 234°C higher than standard polyester.
3411304 - \$25.00



AT-HEIGHT 8 MM BEE LINE EYE & EYE HITCH CORD WITH SEWN TERMINATION

1/2" (11 - 11.5 mm) rope diameter. 30" length. High heat resistance. Vectran core with 75% Technora and 25% polyester cover braid.
3351304 - \$25.00



AT-HEIGHT HRC SEWN EYE & EYE HITCH CORD

28" L. ThermaShield construction features heat-resistant technora and spun Nomex cover. Extremely abrasion resistant. Nomex core provides high strength and low stretch.
3231284 - \$25.00



STERLING 8 MM RIT EYE TO EYE

Provides consistent friction in a wide variety of situations thanks to firmer/tight Twaron sheaths. Made from RIT 500 cord which provides a firm feel and solid durability. ANSI compliant.
SC08AN2E028 28" - \$21.85
SC08AN2E032 32" - \$21.85



PETZL MICROFLIP ADJUSTABLE POSITIONING LANYARD

Reinforced adjustable lanyard designed for positioning in tree care work. Its cable core reduces the risk of severing the lanyard and facilitates moving about on the trunk.
L33 025 2.5 m - \$144.95
L33 040 4 m - \$149.95
L33 055 5.5 m - \$154.95





STERLING 9/16" ATLAS RIGGING LINE

9/16" arbor rigging line is made with a polyester sheath for great durability in all conditions. Its braided nylon core provides smooth handling and the ability to absorb dynamic forces. Works with a Port-a-Wrap, capstan winch or rigging blocks. The Atlas is spliceable or can be ordered with a sewn eye termination for knotless rigging.

LENGTH	DIAMETER	COLOR	STRENGTH	PART	PRICE
150'	9/16"	Blue	MBS 10,386 lbs	AT135060046	\$147.15
200'	9/16"	Blue	MBS 10,386 lbs	AT135060061	\$195.20
600'	9/16"	Blue	MBS 10,386 lbs	AT135060183	\$573.85
150'	9/16"	White	MBS 10,386 lbs	AT135000046	\$142.60
200'	9/16"	White	MBS 10,386 lbs	AT135000061	\$189.05
600'	9/16"	White	MBS 10,386 lbs	AT135000183	\$565.85
150'	9/16"	Yellow	MBS 10,386 lbs	AT135090046	\$147.15
200'	9/16"	Yellow	MBS 10,386 lbs	AT135090061	\$195.20
600'	9/16"	Yellow	MBS 10,386 lbs	AT135090183	\$573.85



STERLING SCION ARBOR CLIMBING LINE

The Scion's ability to absorb dynamic forces makes this rope ideal for DdRT, and SRS. The Scion is a double-braid featuring a burly polyester 24-strand sheath, yet engineered to have decreased elongation, soft handling and easy knotability. The durable sheath is designed to handle mechanical devices and run efficiently through hardware. The Scion can be hand spliced and is also available with sewn terminations.

LENGTH	DIAMETER	COLOR	STRENGTH	PART	PRICE
120'	11.5 mm	Blue	MBS 5,417 lbs	AC115060037SET	\$147.55
150'	11.5 mm	Blue	MBS 5,417 lbs	AC115060046SET	\$175.75
200'	11.5 mm	Blue	MBS 5,417 lbs	AC115060061SET	\$222.90
120'	11.5 mm	Orange	MBS 5,417 lbs	AC115070037SET	\$147.55
150'	11.5 mm	Orange	MBS 5,417 lbs	AC115070046SET	\$175.75
200'	11.5 mm	Orange	MBS 5,417 lbs	AC115070061SET	\$222.90
120'	11.5 mm	Green	MBS 5,417 lbs	AC115190037SET	\$147.55
150'	11.5 mm	Green	MBS 5,417 lbs	AC115190046SET	\$175.75
200'	11.5 mm	Green	MBS 5,417 lbs	AC115190061SET	\$222.90



PELICAN ROPE MATADOR BULL ROPE

By combining a polyester cover over a nylon core, creating a high force rope that offers dependability and unsurpassed resistance to abrasion, sunlight and common chemicals. Provides shock absorption properties similar to nylon but with a tough polyester cover. Urethane coating provides an additional UV protection and increased abrasion resistance. Also available in spools.

LENGTH	DIAMETER	COLOR	STRENGTH	PART	PRICE
150'	5/8"	Orange	MBS 16,000 lbs	4B-20C5-150H	\$149.99
200'	5/8"	Orange	MBS 16,000 lbs	4B-20C5-200H	\$199.99
150'	3/4"	Yellow	MBS 25,000 lbs	4B-24CY-150H	\$189.99
200'	3/4"	Yellow	MBS 25,000 lbs	4B-24CY-200H	\$254.99



PELICAN ROPE ARBORIST-16

This high strength composite climbing rope features a tough 16-strand braided chemical resistant polyester cover over a non-rotational nylon parallel core. This construction results in a smooth running rope ensuring fewer snags and minimal abrasion. Also available in spools.

LENGTH	DIAMETER	COLOR	STRENGTH	PART	PRICE
120'	1/2"	Orange	MBS 7,150 lbs	4A-1605-120H	\$74.99
150'	1/2"	Orange	MBS 7,150 lbs	4A-1605-150H	\$94.99
200'	1/2"	Orange	MBS 7,150 lbs	4A-1605-200H	\$119.99



PELICAN ROPE ARBORIST-24

This double-ply braid features a tough chemical resistant polyester cover over a strong nylon core. Pelican's 24-strand braided cover is smooth running over sheaves. Also available in spools.

LENGTH	DIAMETER	COLOR	STRENGTH	PART	PRICE
150'	7/16"	Yellow	MBS 7,000 lbs	4A-14Y-150H	\$94.99



PELICAN ROPE WIRE CORE FLIP LINE

High visibility flip line constructed with a 16-strand bright neon orange polyester tightly braided over flexible galvanized aircraft cable. Includes rope grab and carabiner.

- FLK-A16-08SE 8' length, 1/2" DIA - \$79.99
- FLK-A16-10SE 10' length, 1/2" DIA - \$80.99
- FLK-A16-12SE 12' length, 1/2" DIA - \$81.99
- FLK-A20-08SE 12' length, 5/8" DIA - \$82.99



STERLING 10.7 MM MARATHON LANYARD

A non-adjustable dynamic rope cowtail for work positioning and back-up belay connection. Stitched-end terminations provide accurate lengths and eliminate bulky knots. MBS 3,822 lbs.

- SC106NYLY020 50 cm - \$20.05
- SC106NYLY024 60 cm - \$20.50
- SC106NYLY031 80 cm - \$21.45
- SC106NYLY039 100 cm - \$21.85



STERLING 9 MM RIT PRUSIK

The 9 mm sewn cord products eliminate bulky knots. Saves time in the field and maintain strength. The 9 mm cord is manufactured using Twaron, a heat and abrasion resistant material.

- SC09APBLP016 16" - \$17.85
- SC09AP2E028 28" - \$23.95
- SC09AP2E032 32" - \$23.95
- SC09AP2E036 36" - \$23.95



PMI 11 MM DYNAMIC SEWN LANYARD

Sewn eyes on each end create a permanent, sewn termination stronger than any knot.

- SG51250 Blue (17.5") - \$22.00
- SG51261 Black (24.0") - \$22.50
- SG51251 Black (32.5") - \$23.00
- SG51262 Black (39.4") - \$23.50



GME SUPPLY FALL PROTECTION SAFETY WIND ENERGY KIT

This kit is designed for those working on wind energy turbines. Kit includes Petzl Volt Wind LT Harness, DBI Sala Force2 Elastic Shock Absorbing Lanyard, Petzl Vertex Best Helmet (choose color), (2) 4-7/8" x 3" Steel Carabiners, GME Supply Large Black Deluxe Gear Equipment Bag.

Upgrades available: DBI Sala ExoFit NEX Global Wind Energy Harness (+\$35.00), GME Supply Wire Rope Grab with Carabiner (+\$149.00), DBI Sala 3/8" Wire Rope Grab with Carabiner (+\$395.00), Petzl Grillon Adjustable Positioning Lanyard (+\$180.00), Petzl Vizir Shadow (+\$60.00), JSP MK8 Evolution Hard Hat (+\$45.00), JSP MK8 Evolution Hard Hat with chin strap (+\$55.00).
90020 - \$799.99



PETZL VOLT WIND LT HARNESS

WEIGHT	7.0 lbs	●●●●○	
LEG STRAPS	QC	TB	MT
CHEST STRAPS	QC	TB	MT
PADDING	-----		
FEATURES	-----		

EasyFit design to keep shape. Ladder climb attachment point for ventral attachment. Wear protectors on waist belt and below dorsal point to limit wear. Podium seat.

G72WFA - \$379.95



GME SUPPLY SKYLOTEC FALL PROTECTION SAFETY WIND ENERGY KIT

This kit is designed for those working on wind energy turbines. Kit includes Skylotec Ignite Proton Tower Harness, Skylotec SkySafe ProFlex Y Lanyard, Skylotec Lory Pro Positioning Lanyard, Kask Zenith Safety Helmet, (2) WestFall Pro 4-7/8" x 3" Steel Carabiners, GME Supply Large Black Deluxe Gear Equipment Bag. Add options for cable grab, helmets.

Upgrades available: Petzl Volt Wind LT Full Body Harness (No charge), DBI Sala ExoFit NEX Global Wind Energy Harness (+\$35.00), DBI Sala Force2 Elastic Lanyard (+\$150.00), GME Supply Wire Rope Grab with Carabiner (+\$149.00), DBI Sala 3/8" Wire Rope Grab with Carabiner (+\$395.00), Petzl Grillon Adjustable Positioning Lanyard (+\$180.00), JSP MK8 Evolution Hard Hat (+\$45.00), JSP MK8 Evolution Hard Hat with chin strap (+\$55.00).

90021 - \$1,249.99



SKYLOTEC IGNITE PROTON WIND HARNESS

WEIGHT	6.2 lbs	●●●●○	
LEG STRAPS	QC	TB	MT
CHEST STRAPS	QC	TB	MT
PADDING	-----		
FEATURES	-----		

The Ignite Proton is the evolution of the popular ARG 51 wind energy harness. It features a sophisticated design that focuses on comfort and usability. The central chest eyelet is flexible to perfectly fit the user.

G-1132-WS - \$419.99



ERGODYNE WIND TECHNICIAN TETHERING KIT

Kit combines the quality of Ergodyne with the knowledge of the Gear Experts giving you what you need to secure your tools and prevent accidents. Handles both large and small tools giving you the flexibility to secure what you need to get the job done.

19658 - \$209.99



KONG BACK-UP MOBILE ARRESTER ANSI

Certified version of the well known Back-Up fall arrester. Safe and simple to use with only one hand and follows along with you as you move along your line. Shifting the special button on the lock mode, it can be used also as a positioning device or a normal locking device. Helps avoid the shocking effects on your ropes typically caused by toothed cams.

8021N0400KK Twistlock - \$166.24

8022N0402KK Autoblock - \$155.15



GME SUPPLY WIND-TECH TOOL PACK

20" Height, 16" Width, 6" Depth. Bag made of 1,000 D Cordura Nylon with rugged #10 YKK zipper. 50 lbs load rated. Complete with two tool trays with tethers.

GM-TECHTOOLPACK Backpack, foam cut out, & tools - \$1,495.50

LUSB131 Backpack only - \$249.00



KITS
SAVE
CASH

All kits can be further customized, just give one of our Gear Experts® a call at (800) 940-6762.



GME SUPPLY FALL PROTECTION SAFETY RESIDENTIAL SOLAR ENERGY KIT

This Solar Kit was developed for workers installing solar panels on roof tops. Kit includes Guardian Seraph Harness, Ergodyne Arsenal Duffle Bag, Guardian Bull Ring Anchor, WestFall Pro Rope Grab Assembly, WestFall Pro 5/8" Lifeline with (1) snaphook end and (1) eye end.

Upgrades available: JSP Evolution Deluxe Climbing Short Brim Safety Helmet (+\$35.00), JSP Comfort Plus Hard Hat (+\$9.00).

90030 - \$229.99

NEW



GME SUPPLY FALL PROTECTION SAFETY GENERAL SOLAR ENERGY KIT

This Solar Kit was developed for workers installing solar panels on roof tops. Kit includes Guardian Seraph Construction Harness with side D-rings, 6' FallTech Web Pass-Thru Anchor, Protecta Rebel 20' Web SRL, (2) 4-1/2" x 2-3/4" Steel Carabiners, Guardian HitchClip 25 Pack, Ergodyne Arsenal General Duty Gear Equipment Bag, GME Supply Canvas Bucket with leather bottom.

Upgrades available: Protecta Rebel 33' Cable SRL (+\$65.00), DBI Sala ExoFit XP Construction Positioning Harness (+\$253.00), 25 pack of Guardian HitchClips (+\$340.00), JSP MK8 Evolution Hard Hat (+\$45.00), JSP MK8 Evolution Hard Hat with chin strap (+\$55.00).

90050 - \$749.99

TEUFELBERGER KM-III MAX STATIC ROPE

The polyester cover is perfectly balanced with the polyamide core to limit rotation, recoil and stretch. The rope construction of the KM III with its 32-strand cover provides for an optimum cover/core ratio ensuring an extraordinarily smooth cover, higher tensile strength values and excellent handling. Black.

C5YY90-14-MASTPAK 30' 11mm - \$94.99

C5YZ90-14-MASTPAK 50' 11mm - \$114.99



GUARDIAN BIG BOSS HORIZONTAL LIFELINE

A temporary, reusable lifeline system that can be used by up to 4 workers simultaneously. The lifeline is made from polyester and has a maximum span of 82'. A rope bag comes included for easy storage and transportation. This system can be easily set-up by just one person, but always ensure that all aspects of horizontal lifeline installation, inspection, and maintenance are supervised by a Qualified Person. Worker capacity range: 130-310 lbs. Minimum breaking strength: 5,000 lbs. ANSI and OSHA compliant.

30800 - \$749.99





GUARDIAN ANCHOR POINT

Permanent installation onto wood, steel, and concrete substrates (fasteners are for wood and steel applications). Features a 12" anchor post that extends so that it is accessible during and after construction. Use this roof anchor with horizontal lifelines, vertical lifelines, SRLs, and lanyards. Made from galvanized steel, making it extremely durable. Post extends past roofing substrate to attachment point accessible. Round post works with most off-the-shelf flashing kits. 130 - 420 lbs worker capacity range, 5,000 lbs minimum breaking strength, ANSI compliant.

- CB-12
- 00645 Anchor & choice of wood or metal fasteners - \$257.99
- 00668 40 Wood fasteners - \$6.99
- 00669 40 Metal fasteners - \$12.99
- CB-18
- 00656 Anchor point for concrete (no swivel) - \$263.99
- 00657 Anchor point for wood or metal (no swivel) - \$286.99

GUARDIAN PITCHPRO ANCHOR POINT

Made from lightweight and durable powder-coated aluminum, the HitchClip is easy to install, and functions as a permanent rooftop anchor. Thanks to its patent pending "key-hole" design, the HitchClip can be used in combination with a large variety of accessories, allowing it to be used to set up guardrail systems, staging areas, and more.



- 10540 Black - \$15.95
- 10541 Brown - \$15.95
- 10542 Grey - \$15.95
- 10543 Black, 25 pack - \$374.95



GUARDIAN TWO-WAY UNIVERSAL STANDING SEAM ROOF CLAMP

Lightweight, reusable, durable, and easy-to-use. The clamp also features a unique, reversible design that allows for seams up to 1" wide. The MR-24, VSR or similar profiles can be covered with one clamp.



- 10600 - \$205.99

GUARDIAN BULL RING ANCHOR

Perfectly suited for personal fall arrest, restraint, or work positioning applications. Substrate must be roof truss or support beam that is minimum of 3" thick CDX or better. All fasteners must be fully embedded in the substrate. 130 - 420 lbs worker weight capacity.



- 00484 - \$53.99

GUARDIAN TEMPER REUSABLE ROOF ANCHOR

Reusable anchorage connector designed for temporary use on wood rooftops, fits all roof pitches from flat to 12/12, composed of thick plated steel for longer lasting product life, can be installed with either screws or duplex nails (depending on roof pitch), designed offset holes down the center.



- 00455 - \$22.99

WESTFALL PRO TRAILING ROPE GRAB WITH LANYARD

5/8" (16 mm) rope diameter. Designed for 3-strand rope. Rope grab with 2" ring. Anti-panic lock for added safety. Anti-inversion plate for proper installation on rope. Includes 3' shock absorbing lanyard. ANSI compliant.



- 60601 Rope grab with lanyard - \$84.95
- 6050 Rope grab only - \$59.99

KONG 802 BACK-UP MOBILE FALL ARRESTER

3/8" - 7/16" (10 - 12) mm rope diameter. Works on vertical or angled rope. Moves up or down along the rope without manual intervention. Easy to install and remove at any point on the rope. For rope access applications unit can be used with tug cord. Non-aggressive cam design. One person weight capacity: 220 lbs. ANSI rated.



- ANSI-8021N0400KK Twistlock - \$166.24
- ANSI-8022N0402KK Autoblock - \$155.15



WESTFALL PRO 3-STRAND COMPOSITE VERTICAL LIFELINE

Constructed of a 5/8" 3-strand polyester rope, and double locking safety snap hook. Lightweight, abrasion resistant, low stretch, and energy absorbent. 420 lbs capacity, 5,600 lbs MBS, and ANSI compliant.



LENGTH	END	END	PART	PRICE
300'	Eye	Eye	5800-300	\$210.99
25'	Snaphook	Eye	5805-025	\$54.99
50'	Snaphook	Eye	5805-050	\$68.99
75'	Snaphook	Eye	5805-075	\$83.99
100'	Snaphook	Eye	5805-100	\$97.99
200'	Snaphook	Eye	5805-200	\$155.99
300'	Snaphook	Eye	5805-300	\$213.99
25'	Snaphook	Snaphook	5810-025	\$90.99
50'	Snaphook	Snaphook	5810-050	\$105.99
75'	Snaphook	Snaphook	5810-075	\$119.99
100'	Snaphook	Snaphook	5810-100	\$134.99
200'	Snaphook	Snaphook	5810-200	\$192.99
300'	Snaphook	Snaphook	5810-300	\$259.99





ROCK EXOTICA NANO SWIVEL

The Nano is one of the lightest load rated swivels available, and features a thrust bearing to provide a compact form factor. The connection eye uses an integrated rubber o-ring that holds the Nano snugly in place on most carabiners. Weight: 2.00 oz, breaking strength: 23 kN, working load: 3 kN.

S11 - \$70.00



ROCK EXOTICA ORBITOR SWIVEL

This compact, low profile swivel is ideal for special uses where a smooth form, minimum size and minimum weight are required. Weight: 3.52 oz, breaking strength: 26 kN, working load: 5 kN.

S3 - \$67.00



ROCK EXOTICA ROTATOR ROUND SWIVEL

The two large 1.3" (32 mm) eyes are ideal for use with webbing, and allows for connection of multiple carabiners while still aligning perfectly with only one connector. Weight: 4.48 oz, breaking strength: 36 kN, working load: 5 kN.

S2L - \$61.00



ROCK EXOTICA SHACKLE SWIVEL

Saves valuable head space by allowing you to connect webbing, eyes or thimbles directly to the swivel without a carabiner. Steel shackle bolt .375", 9.5 mm diameter.

SS1 0.75" - \$85.00



ROCK EXOTICA MACHINED MINI 1.1" PULLEY

7/16" (11 mm) maximum rope diameter, 1.1" (28 mm) sheave diameter. Milled from T6 aluminum for optimal strength.

P21-B - \$60.00



ROCK EXOTICA MACHINED RESCUE 1.5" PULLEY

1/2" (13 mm) maximum rope diameter, 1.5" (38 mm) sheave diameter. Lightweight pulley with low resistance bearing.

P22-B Single pulley - \$65.00
P22D-B Double pulley - \$102.00



ROCK EXOTICA TRIRIG RIGPLATE

The lightest high performance 3 hole rigplate. All edges are rounded with carbide milling cutters for a full, smooth radius. Weight: 1.8 oz, MBS: 8093 lbs (36 kN), height: 2.8 in (72 mm), width: 3.3 in (84 mm).

RP1-B - \$28.00



ROCK EXOTICA RESCUE EIGHT

A traditional style figure eight with side ears to add friction. Made from durable T6 aluminum and machined from a solid block. Weight: 6.4 oz, height: 6" (152 mm), width: 6.25" (158 mm), max Rope (single rope): 13 mm, max Rope (Double Rope): 10.5 mm, breaking strength: 22 kN.

F3 - \$42.00



LIFTALL STEELFLEX & POLYESTER STAGE SLING

These lightweight round slings are ideal for easy and inconspicuous suspension of stage sound and lighting equipment. Black sleeve material helps sling blend into its surroundings. Lift-All Stage Slings maintain the basic Tufflex features, advantages and benefits except that the color coding of the slings is achieved by using a color coded identification Tuff-Tag. Double Wall sleeve material is standard.



DESCRIPTION	PART	WIDTH	MIN LENGTH	VERTICAL	CHOKER	BASKET	PRICE	+/FT
Polyester Stage Sling	BSEN30	1-1/8"	1-1/2'	2,600 lbs	2,100 lbs	5,200 lbs	\$8.00	\$3.50
	BSEN60	1-1/2"	1-1/2'	5,300 lbs	4,200 lbs	10,600 lbs	\$12.00	\$4.50
	BSEN90	1-7/8"	3'	8,400 lbs	6,700 lbs	16,800 lbs	\$16.00	\$5.50
Steelflex	GACEN60	1-1/2"	3'	5,300 lbs	4,200 lbs	10,600 lbs	\$40.00	\$18.50



STERLING ROPE 7/16" HTP STATIC ROPE

7/16" (11 mm) diameter rope. Maximum strength with low stretch. A multi-use rescue and rappel rope perfect for rope rescue, rope access and efficient ascending/descending. Low-stretch properties and high-moisture resistance to operate consistently in wet and dry conditions. Meets NFPA 1983: Technical, ANSI Z133.

- SR-P110040046 150', 46 m - \$159.55
- SR-P110040050 165', 50 m - \$173.35
- SR-P110040061 200', 61 m - \$211.55
- SR-P110040092 300', 92 m - \$315.85
- SR-P110040183 600', 183 m - \$621.90
- SR-P110040200 660', 200 m - \$679.70



* All hardware photos are proportionately scaled.

**SEE MORE
CARABINERS
ON PAGE 50**



C81A



C82A



M31 TLN



OP76S35Q



OP76S35QLCE



C1A-B



C1S-B



C2A-B



C2S-B



C3A-B



C3S-B



M36A-TLN



M36A-SLN



M34A-TLN



M34A-SLN



M33A-TLN



M33A-SLN

PART	DESCRIPTION	LENGTH	WIDTH	WEIGHT	GATE	MBS	PRICE
C81A	Rock Exotica SwivaBiner Auto Lock Aluminum Carabiner	7.3"	2.6"	0.36 lbs	0.84"	30 kN	\$88.00
C82A	Rock Exotica SwivaEye Auto Lock Aluminum Carabiner	5.4"	2.6"	0.30 lbs	0.84"	30 kN	\$78.00
M31 TLN	Rock Exotica RockSteel Auto Lock Steel Carabiner	4.9"	3.0"	0.55 lbs	1.2"	50 kN	\$42.00
OP76S35Q	Omega Pacific Standard D Quick-Lok Steel Carabiner	4.4"	2.8"	0.49 lbs	0.95"	51 kN	\$43.95
OP76S35QLCE	Omega Pacific Captive-Eye D Quick-Lok Steel Carabiner	4.4"	2.8"	0.49 lbs	0.95"	51 kN	\$45.95
C1A-B	Rock Exotica Pirate Auto Lock Aluminum Carabiner	4.2"	2.8"	0.19 lbs	1"	26 kN	\$20.00
C1S-B	Rock Exotica Pirate Screw Lock Aluminum Carabiner	4.2"	2.8"	0.18 lbs	1"	26 kN	\$14.50
C2A-B	Rock Exotica RockD Auto Lock Aluminum Carabiner	4.5"	2.7"	0.20 lbs	0.95"	29 kN	\$20.00
C2S-B	Rock Exotica RockD Screw Lock Aluminum Carabiner	4.5"	2.8"	0.16 lbs	0.95"	29 kN	\$14.50
C3A-B	Rock Exotica RockO Auto Lock Aluminum Carabiner	4.4"	2.5"	0.17 lbs	0.9"	24 kN	\$20.00
C3S-B	Rock Exotica RockO Screw Lock Aluminum Carabiner	4.2"	2.8"	0.16 lbs	0.93"	24 kN	\$14.50
M36A TLN	Petzl William Triact Lock Aluminum Carabiner	4.5"	3.0"	0.20 lbs	1.06"	27 kN	\$23.95
M36A SLN	Petzl William Screw Lock Aluminum Carabiner	4.6"	3.1"	0.20 lbs	1.1"	27 kN	\$19.95
M34A TLN	Petzl Am'D Triact Lock Aluminum Carabiner	4.5"	2.5"	0.17 lbs	0.94"	27 kN	\$22.95
M34A SLN	Petzl Am'D Screw Lock Aluminum Carabiner	4.4"	2.4"	0.17 lbs	0.91"	27 kN	\$17.95
M33A TLN	Petzl OK Triact Lock Aluminum Carabiner	4.4"	2.4"	0.17 lbs	0.87"	25 kN	\$20.95
M33A SLN	Petzl OK Screw Lock Aluminum Carabiner	4.4"	2.6"	0.15 lbs	1"	25 kN	\$15.95





MSA ALTAIR 5X MULTIGAS DETECTOR

3.1" L, 6.5" W, 2.0" D. Detects LEL, O₂, CO, and H₂S. Capable of measuring up to 6 gases simultaneously and is now available with integrated PID sensor for VOC detection. Driven by advanced MSA XCell Sensor Technology, the Altair 5X Gas Detector delivers faster response time, better stability, accuracy, longer service life, and cost savings over the life of the instrument. The unit features exclusive MotionAlert, which lets others know if the user has become immobile, and InstantAlert, a manual alarm that alerts others of potentially dangerous situations. Bluetooth wireless connectivity paired with MSA Altair Connect app.

10116924 - \$2,149.99



MSA ALTAIR 4XR MULTIGAS DETECTOR

4.4" L x 3.0" W x 1.4" D. Detects LEL, O₂, H₂S, CO, and S. Charcoal case, North American charger. Outfitted with rapid-response MSA XCell sensors. The unit features exclusive MotionAlert, which lets others know if the user has become immobile, and InstantAlert, a manual alarm that alerts others of potentially dangerous situations. Bluetooth wireless connectivity paired with MSA Altair Connect app. This rugged unit is designed to withstand a drop of 25 ft (7.5 m). IP68 waterproof to 6 ft (2 m) for 1 hour.

10178557 - \$1,049.99



10115522

MSA ALTAIR 4X MULTIGAS DETECTOR

4.4" L x 3.0" W x 1.31" D. Detects LEL, O₂, H₂S & CO. Simultaneously measures up to four gases from a wide range of XCell sensor options including combustible gases. Surpasses industry standards in several crucial areas. This versatile portable detector is a perfect match for industries ranging from fire fighting to welding, and its digital sensor output makes it less likely to suffer from RF interference. The unit features exclusive MotionAlert, which lets others know if the user has become immobile, and InstantAlert, a manual alarm that alerts others of potentially dangerous situations. This rugged unit is designed to withstand a drop of up to 20 ft (6 m) and uses less than half as much calibration gas as the industry average.

10115521 Regular case - \$1,049.99
10115522 Glow in the dark case - \$1,069.99



MSA ALTAIR 5X MULTIGAS DETECTOR MONO KIT WITH 10' SAMPLING LINE & 1' PROBE

3.1" L, 6.5" W, 2.0" D. Capable of measuring up to 6 gases simultaneously and is now available with integrated PID sensor for VOC detection. Features MotionAlert, InstantAlert, and Bluetooth wireless connectivity.

10116926 Detects LEL, O₂, CO, H₂S - \$2,399.99
10165446 Detects LEL, O₂, CO, H₂S, PID - \$4,299.99



10092521



10092522



10092523

MSA ALTAIR SINGLE GAS DETECTOR

1.3" L, 2.1" W, 3.4" D. The unit is designed to notify users of gas monitoring with visual alarms of ultra-bright LED lights and a screen display, distinct audible alarms of over 95 decibels, and vibrating alarms. The triple alarm system will ensure that users and those nearby are appropriately alerted to gas situations in the environment. Most notably, the alarm system is designed to alert users regardless of hearing or visual impairment.

10092521 Hydrogen sulfide (H₂S) - \$114.99
10092522 Carbon monoxide (CO) - \$269.99
10092523 Oxygen (O₂) - \$269.99



MSA CALIBRATION TESTING GAS BOTTLE

6.25" H, 15.25" L, 34 liters. MSA offers a complete line of calibration gas cylinders to calibrate all instruments. The gas mixture in calibration gas cylinders is certified to be prepared gravimetrically, using NIST traceable weights. The lot number and nominal value of the gas constituents in volume, percent by mass, PPM, or volume is specified on the cylinder.

10048280 - \$284.99



MSA GALAXY GX2 AUTOMATED TEST SYSTEM

12" H, 6.5" W. Comes standard with pre-configured plugs, barbs, fresh air filters, spare parts kit, power supply and plug, Ethernet cable, and screen protector. Operates on 100-200 VAC (47-63 Hz). Provides a simple and efficient approach to testing, calibration, and charging. With numerous user features, advanced software, optional accessories, and automatic cost reduction, the automated test system is an automatic choice for workplace safety managers.

10128630 - \$2,194.99



DBI SALA ADVANCED ALUMINUM TRIPOD WITH SALALIFT II WINCH

7' aluminum tripod (model 8000000), telescoping adjustable locking legs, built-in pulley system, specialized safety shoes and leg support chain, integrated 5,000 lb eye bolt anchor points, manually operated winch (model 8102001), 60' of 1/4" galvanized steel wire rope, 6:1 gear ratio mechanical advantage, free-wheel mode, built-in fall protection, overload clutch, swiveling snaphook with impact indicator, quick-connect winch/SRL mount bracket, equipped with i-Safe.

8300030 60' - \$3,049.99

8300032 90' - \$3,149.99

8300034 120' - \$3,199.99



GO TO WWW.GMESUPPLY.COM/CONFINED TO VIEW ALL CONFINED SPACE EQUIPMENT



VIDEO

FRENCH CREEK 3-WAY SELF-RETRACTING LIFELINE

50' galvanized wire rope; manufactured with rugged, lightweight cast aluminum housing; includes a mounting bracket for tripod or davit systems used for raising, lowering, for rescue or retrieval; uses friction brake that prevents the crank handle from free-wheeling while under load.

R50G - \$1,375.00



VIDEO

FRENCH CREEK MANUAL RETRIEVAL WINCH

50' galvanized wire rope; manufactured with rugged, steel frame and drum; unit includes a #45 pulley and carabiner for attaching the line to an anchor; friction brake prevents unit from free-wheeling when under load.

MW50G 50' - \$437.00

MW100G 100' - \$532.00



VIDEO



ALLEGRO 8" COM-PAX-IAL BLOWER WITH CANISTER

This versatile system features the 8" COM-PAX-IAL blower with 25' of ducting; designed with the quick-connect clipping system which allows workers to attach the canister, tools-free, to the input side for powerful extraction or output side for ventilation; ducting stores conveniently within the canister; compact blower designed for easy use and storage without sacrificing airflow; polyethylene housing and canister assembly; lightweight, corrosion; UV and chemical resistant; safety orange color for easy visibility; bottom enclosure to protect electrical components; carry handle molded into blower and canister housing; steel powder coated grill.

9533-25 - \$381.99

FRENCH CREEK CONFINED SPACE TRIPOD

7' aluminum tripod, (2) attachment points on head. Designed to withstand 5,000 lbs of vertical load. Lightweight and portable. Quick and easy single person setup. Adjustable/locking aluminum legs, safety chain, and non-slip rubber safety shoes.

S50G-7-M7 7' Tripod with rescue unit & winch - \$2,687.99

TP7 7' tripod - \$482.99

TP9 9' tripod - \$687.49

S50G-7 7' Tripod with rescue unit - \$1,903.99

S50G-9 9' Tripod with rescue unit - \$2,029.99



ELK RIVER ECONOMY EZE-MAN CONFINED SPACE SYSTEM

Includes Deluxe EZE-Man winch 3:1 ratio, tripod pulley, tripod head assembly, tripod leg assembly, one auto-lock carabiner, yoke, tote bag, tripod bag, winch bag, harness bag, five D-ring universal harness, rope grab with lanyard, nylon rope lifeline.

05611 25' - \$2,235.49

05612 50' - \$2,435.48

05613 75' - \$2,525.99

05614 100' - \$2,458.20





DBI SALA CONFINED SPACE TRIPOD PULLEY

Confined space pulley bolts to 8000000 series tripod leg and routes winch/SRL lifeline up to 1/4" (6.3 mm) diameter. Zinc plated steel and nylon construction. Detent pin style lifeline retention system. Compact design can be left in place indefinitely. Accommodates lifelines up to 1/4" (6.3 mm).

8003238 - \$197.99



DBI SALA SALALIFT II WINCH

60' of 1/4" galvanized steel wire rope and swivel snap hook, mounting bracket, and carrying bag. 6:1 gear ration mechanical advantage. Features quick mount bracket, free-wheel mode, and overload clutch. Durable corrosion resistant construction. Level wind system. Reserve lifeline retention system. Swiveling snap hook with impact indicator. Equipped with i-Safe.

8102001 Galvanized steel wire - \$1,849.99

8102003 Stainless steel wire - \$2,129.99



DBI SALA CONFINED SPACE TRIPOD MOUNTING BASE

Bolts to the 8000000 series tripod leg and mates with quick-connect bracket on DBI Sala branded winch or SRL. Zinc plated steel construction. Simple nut and bolt installation. Compact design can be left in place indefinitely.

8005048 - \$33.99



DBI SALA ADVANCED ALUMINUM TRIPOD

7' (2.1 m) aluminum tripod with adjustable locking legs, safety chain, safety shoes, top pulley and quick-mount bracket. Built-in pulley system. Rubber safety shoes with spiked edges. Safety leg support chain. Integrated 5,000 lbs (22 kN) eyebolt anchor points. Quick connect winch/SRL mount bracket. Equipped with i-Safe. Order mechanical winch/SRL device(s) separately.

8000000 - \$1,199.99



DBI SALA ADVANCED FLOOR MOUNT SLEEVE DAVIT BASE

For Advanced offset davit mast. Bolts to concrete or steel floors. Corrosion resistant plated hardware. High strength steel construction. 360 degree davit mast rotation. PVC davit mast sleeve liner.

8516190 Zinc plated - \$494.99

8518347 Stainless steel - \$1,203.99



DBI SALA ADVANCED ONE-PIECE ADJUSTABLE OFFSET DAVIT MAST

One-piece adjustable offset davit mast with telescoping reach of 11.5" to 27.5" and adjustable vertical height of 66" to 76". Integrated 5,000 lbs (22 kN) mast anchorage point. Built-in primary and secondary pulleys. Integral secondary fall arrest anchorage point. Quick mount winch/SRL bracket, lightweight corrosion.

8518382 - \$2,649.99



Fall Protection





GO TO WWW.GMESUPPLY.COM/BAGS
TO VIEW ALL BAGS & BUCKETS

V = VOLUME
DIA = DIAMETER
L = LENGTH
W = WIDTH
H = HEIGHT

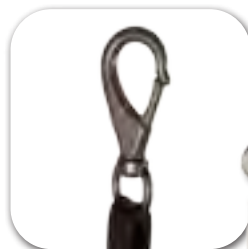

**GME SUPPLY
LEATHER BOTTOM
CANVAS BUCKET**

17" H, 12" DIA, 1,923 V,
load rated 100 lbs. Made of
heavy-duty canvas, high-density
polyethylene top ring for strength
and chemical resistance,
reinforced high-strength
webbing strap, black leather
cuff at bottom extends 3" up the
side, inside pocket measures 8"
x 8", made in the USA.

GM-5105 - \$61.99

**GM-5104S With swivel
snaphook - \$64.99**

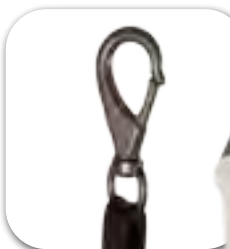

**GME SUPPLY
PLASTIC BOTTOM
CANVAS BUCKET**

15" H, 12" DIA, 1,696 V,
load rated 75 lbs. Made of
heavy-duty canvas, high-density
polyethylene top ring for
strength and chemical
resistance, reinforced high-
strength webbing strap, black
molded polypropylene bottom,
made in the USA.

GM-5110 - \$36.99

**GM-5109S With swivel
snaphook - \$39.99**



**KLEIN TOOLS
VINYL BUCKET TOP**

Compatible with 5104 and 5109
series buckets, closure with
velcro brand fasteners, and safety
strap loop to ensure connection
to bucket.

51TOP - \$14.99



**KLEIN TOOLS HARD
BODY OVAL BUCKET**

10" H, 14" L, 7" W, 1,539 V.
(15) inside pockets, leather
skinning knife sheath, non-
conductive plastic exterior.

5144HBS - \$69.99

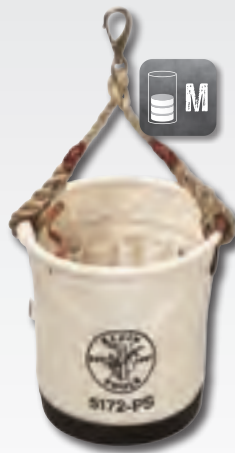

**KLEIN TOOLS TAPERED
WALL CANVAS BUCKET
WITH 15 POCKETS**

12" H, 12" top DIA, 9" bottom DIA,
1,357 V. (15) inside pockets.

5172PS - \$76.99



**GME SUPPLY MINI
LEATHER BOTTOM
BUCKET**

6" H, 5" DIA, 118 V. Black
leather-reinforced bottom, heavy-
duty natural canvas, high-strength
webbing handle, makes great gift.

GM-5104MINI - \$14.95



**GME SUPPLY LEATHER
BOTTOM BUCKET WITH
CONNECTION POINTS**

17" H, 12" DIA, 1,923 V, Leather
bottom bucket with velcro top, 2 inside
pockets, and 4 inner D-rings.

GM-5104VTPD - \$94.99





GEAR EXPERTS®

“ Our Gear Experts take pride in offering custom solutions for any problem. In 2017 we were tasked with creating a lifting kit to get tools to their workers at heights. They wanted one SKU that was easy to order and always offered the same equipment. This created efficiency from the top down, making the job easier for the procurement department, receiving department, and workers on site. They knew what each lifting kit would come with and every worker was trained on an identical core of equipment. Slapping their logo on the bucket was icing on the cake, it created a sense of pride that they had the most efficient solution for a common problem. Reach out to our Gear Experts and they can take you through the process of setting up a SKU, getting your logo on a bag or bucket, and getting this in your workers hands. ”



AUSTIN PAINTER

Great Lakes Regional Sales Manager



ARSENAL SYNTHETIC LEATHER BOTTOM CANVAS BUCKET WITH D-RINGS

17" H, 12.5" DIA, 2,086 V, load rated 150 lbs. Interior pocket.

5960 With D-rings - \$76.99

5960T With D-rings & detachable top - \$96.99

5930 Without D-rings - \$85.99

5930T Without D-rings, with detachable top - \$108.95



ARSENAL LEATHER BOTTOM CANVAS BUCKET WITH SWIVELING CARABINER

17" H, 12.5" DIA, 2,086 V, load rated 150 lbs. Interior pocket.

5940 Bucket - \$94.99

5940T With detachable top - \$114.99



Swivel



Nylon detachable top



ARSENAL PLASTIC BOTTOM CANVAS BUCKET

15" H, 12.5" DIA, 1,840 V, load rated 100 lbs. Interior pocket.

5733 Bucket - \$52.99

5733T With detachable top - \$70.99

5743 With swivel - \$60.99

5743T With detachable top & swivel - \$78.99



ARSENAL LEATHER BOTTOM CANVAS BUCKET

17" H, 12.5" DIA, 2,086 V, load rated 150 lbs. Interior pocket.

5730 Bucket - \$85.99

5730T With detachable top - \$99.99



ARSENAL POLYESTER BOTTOM CANVAS BUCKET WITH SWIVELING HOOK

15" H, 12.5" DIA, 1,840 V, load rated 150 lbs. Interior pocket.

5970 Bucket - \$59.99

5945T With detachable top - \$79.99



ARSENAL LEATHER BOTTOM CANVAS BUCKET

20" H, 16" DIA, 4,021 V, load rated 150 lbs. Interior pocket.

5935 Bucket - \$69.99

5935T With detachable top - \$89.99





**KLEIN TOOLS WIDE-OPENING
CANVAS BUCKET**

15" H, 12" DIA, 1,696 V, load rated 75 lbs. Black molded polypropylene bottom, high-density polyethylene top ring.

- 5109 Bucket - \$40.99
- 5109P With inside pocket - \$45.99
- 5109S With swivel - \$48.99
- 5109PS With inside pocket & swivel - \$54.99
- 5109SLR With swivel snaphook - \$56.99

**KLEIN TOOLS HEAVY
DUTY TOP CLOSING
CANVAS BUCKET**

17" H, 14" DIA, 2,617 V, load rated 150 lbs. Top zipper closure, leather bottom.

- 5104CLR17 17" H - \$102.99
- 5104CLR22 22" H - \$117.99

**KLEIN TOOLS
LEATHER BOTTOM
CANVAS BUCKET**

17" H, 12" DIA, 1,923 V, load rated 100 lbs. Leather-reinforced bottom, inside pocket, polypropylene-rope handle reinforced with leather for water resistance and strength.

- 5104 Bucket - \$74.99
- 5104S With swivel - \$81.79

**KLEIN TOOLS LEATHER
BOTTOM BUCKET WITH
CONNECTION POINTS**

17" H, 12" DIA, 1,923 V, load rated 100 lbs. Six small D-rings sewn in the interior provide secure connection points for tethers, extra large hook fits onto large-sized rigging equipment.

- 5104OCTO - \$99.99



**KLEIN TOOLS
MINI LEATHER
BOTTOM BUCKET**

6" H, 5" W, 118 V. Miniature version of 5104 bucket, leather-reinforced bottom, heavy duty natural canvas, rope handle, great gift for tower climbers, riggers, contractors, and more.

- 5104M - \$14.95

**KLEIN TOOLS
CANVAS BUCKET**

13" H, 12" top DIA, 9" bottom DIA, 1,470 V. Black polypropylene bottom, high-density polyethylene top ring, polypropylene-rope handle reinforced with leather for water resistance and strength.

- 5113 - \$43.99
- 5113S With swivel - \$49.99

**KLEIN TOOLS CANVAS
BUCKET**

14" H, 9" DIA, 891 V. Black molded polypropylene bottom, high-density polyethylene top ring, rope handle.

- 5106 Bucket - \$37.99
- 5106P 2 inside pockets - \$47.99
- 5106S With swivel - \$44.99

**KLEIN TOOLS
CANVAS BUCKET**

12" H, 12" top DIA, 9" bottom DIA, 1,357 V. Swivel snap, black molded polypropylene bottom, rope handle.

- 5103S - \$50.99

**KLEIN TOOLS HEAVY-
DUTY CANVAS BUCKET
WITH 4 POCKETS**

12" H, 12" top DIA, 9" bottom DIA, 1,357 V. (4) outside pockets, black molded polypropylene bottom, rope handle, equipped with swivel snap hook.

- 5171PS - \$66.99





QUICK SHIP VIDEO MADE IN USA

GME SUPPLY LARGE UTILITY BAG

8" x 3" top diameter, inside pocket, leather reinforced bottom, ventilation eyelet in bottom, snap belt connection.

GM-5142P 9" L, 10" W - \$27.99

GM-5141P 10" L, 12" W - \$30.99



NEW QUICK SHIP

GME SUPPLY PREMIUM TOP-CLOSING NYLON BOLT BAG WITH CONNECTION POINTS

16.75" L, 10" W, 1" H. Specially developed by our Gear Experts to be the premium bolt bag for the at-height worker. The Premium Top-Closing Bolt Bag features (2) exterior D-ring connection points for tethering tools on the outside of your bag. Tough fabrics were selected to give your bag a combination of durability, weather-resistance, a more sleek look. The inside of the bag is lined with a bright red webbing so you can find tools much easier than digging through darker colored bags. The bag is riveted for extra strength and has bull-pin loops on each side. It has a tunnel loop belt connection and is topped off with our exclusive GME Supply logo on the front.

5816TCPD - \$44.99

GEAR EXPERTS®

“ This bolt bag was specially developed by our Gear Experts to be your premium bolt bag for at-heights work. First, the Premium Top-Closing Bolt Bag features (2) exterior D-ring connection points for tethering tools on the outside of your bag. Tough fabrics were selected to give your bag a combination of durability, weather-resistance, and a more sleek look. The inside of the bag is lined with a bright red material so you can find tools much easier than digging through a darker colored bag. The bag is riveted for extra strength and has bull-pin loops on each side. It has a tunnel loop belt connection and is topped off with our exclusive GME Supply logo on the front. ”



JIM ZEPP

Southern Regional Sales Manager



KLEIN TOOLS BOLT RETENTION CANVAS POUCH

9" H, 5" L, 10" W. Neoprene top helps retain 1/2" and 1" bolts and nuts inside pouch. Double bottom for reinforcement. (2) D-rings. Tunnel loop fits belts up to 3" (76 mm) wide.

5416TBR - \$39.99

KLEIN TOOLS NUT & BOLT POUCH

9"H, 3.5" L, 10" W. Interior pocket. Top sides of pouch reinforced with leather. Inside bottom reinforced with leather and ventilating eyelet. Metal snaps on loops. Top edge reinforced with 1/4" rope.

51A - \$27.99

KLEIN TOOLS BULL-PIN & BOLT BAG

10" H, 5" L, 9" W. Bull-pin loop on each side, loop belt connection.

5416 Standard - \$16.99

5416T Tunnel loop - \$18.99

5416L Leather with tunnel loop - \$49.99

KLEIN TOOLS UTILITY BAG

9" L, 10" W. 8" x 3" top DIA, ventilating eyelet in bottom, snap belt connection.

5142 Without inside pocket - \$30.99

5142P With inside pocket - \$32.99

KLEIN TOOLS EXTRA LARGE UTILITY BAG

5" H, 10" L, 12" W. 9" x 5" top DIA, inside pocket, leather reinforced bottom, ventilation eyelet in bottom, snap belt connection.

5141P - \$32.99



SEE TOOL TETHERS
ON PAGE 184 }

GME SUPPLY TOP-CLOSING BOLT BAG WITH CONNECTION POINTS

Bull-pin loops, durable Cordura 3" drawstring closing top, D-ring connection points, tunnel loop belt connection, exclusive GME Supply logo.

GM-5416TCPD 9" L, 5" W, 12" H - \$32.99

GM-5516TCPD 9" L, 5" W, 18" H - \$39.99



5416TCP



5416TC & 5416TCP



BAGS & BUCKETS // CANVAS BAGS

GME SUPPLY BULL-PIN & BOLT BAG

10" H, 5" L, 9" W. Bull-pin loop on each side, tunnel loop belt connection, heavy-duty construction, up to 3" belt capacity, exclusive GME flame logo.

GM-5416T - \$13.99



5426TCP

GME SUPPLY HEAVY DUTY TOP-CLOSING BOLT BAG

9" L, 5" W, 12" H. Bull-pin loop on each side, durable Cordura 3" drawstring closing top prevents items from falling out, inside pocket, tunnel loop belt connection, up to 3" wide belt capacity, exclusive GME Supply logo.

GM-5416TCP With inside pocket - \$28.99

GM-5416TC Without inside pocket - \$24.99

GM-5426TCP With snap belt connection - \$32.99



KLEIN TOOLS TOP-CLOSING BOLT BAG

9" L, 5" W, 12" H. Bull-pin loop on each side, 3" drawstring closing top, inside pocket, loop belt connection.

5416TCP With inside pocket - \$29.99

5416TC Without inside pocket - \$28.99



KLEIN TOOLS TOP-CLOSING BOLT BAG

5" L, 9" W, 9" H. Bull-pin loop on each side, 4 connection points inside, 2 on front, belt loop connection.

5416OCTO - \$28.99



ELK RIVER DEEP BOLT BAG WITH DRAWSTRING

14" L, 2.5" W, 10" H. Drawstring closing top, inside pocket, bull-pin loop on each side, tunnel loop belt connection.

84522 - \$49.49



ELK RIVER BOLT BAG WITH DRAWSTRING

10" L, 2.5" W, 9" H. Drawstring closing top, bull-pin loops, tunnel loop belt connection.

84521 With top-closing - \$48.72

84520 Without top-closing - \$38.46



ELK RIVER HEAVY DUTY DRAWSTRING BOLT BAG

13" L, 3" W, 10" H. Sewn and riveted for increased durability, heavy duty webbing on bottom, exterior front sleeve and interior pocket, (2) tool ring connections.

84523 - \$67.47





S47YS



P42



PETZL TOOLBAG TOOL POUCH

Constructed of durable material with a drawstring top closure for safety and security. Water resistant. Attaches to any type of harness. Don't forget to include a Caritool clip that is compatible with the size of your tool pouch to clip onto your harness.

S47YS 6.75" H (2.5 liters) - \$29.95

S47YL 11" H (5 liters) - \$39.95

P42 Caritool standard clip - \$8.95

P42L Caritool large clip - \$18.95

ARSENAL TOPPED PARTS POUCH

7.5" L, 7.5" W, 12" H. Hands-free, self-closing trap door closure that prevents small parts, hardware, and tools from falling when working at-heights; 20 oz water resistant canvas; trap door closure for safety and security; patented nickel plated storm drain; (2) exterior nickel plated D-rings for tool tether attachment; (2) exterior tool loops; maximum safe working capacity: 20 lbs.

5528 - \$28.99



ARSENAL TOP-CLOSING BOLT BAG

10" L, 5" W. Cinch-up top, (2) exterior tool loops, storm drain, tunnel loop belt connection.

5725 9" H - \$28.99

5728 13" H - \$30.99



ARSENAL TOP PARTS TARAPULIN POUCH

7.5" L, 7.5" W, 12" H. Waterproof, trap door, storm drain, (2) D-rings for tool tethers, (2) exterior tool loops.

5538 - \$28.99



PMI MAGNETA BAG

8" W, 10" H. Sturdy construction for carrying bull pins and bolts; Easily attaches to harness; Top closure prevents accidental spills and drops; Magnetic plate on front offers temporary hardware storage on the outside of the pocket.

RB44061 - \$19.95



DBI SALA EXTRA DEEP SMALL PARTS POUCH

3" W, 11" H. Self-closure system, made from 18 oz duck canvas, extra deep design provides additional pouch space, can be used from a belt or harness.

1500123 - \$52.99



DBI SALA EXTRA DEEP TOOL POUCH WITH D-RING & RETRACTORS

5" L, 8.75" W, 13" H. (2) retractors and (1) D-ring; made of heavy duty canvas with inner lining; multiple inner pockets; magnetic strip closure system with side release buckle.

1500128 - \$79.95



THE ULTIMATE GEAR BAG FOR REAL TOWER CLIMBERS



GME SUPPLY DELUXE GEAR BAG

27.5" L, 12" W, 15.5" H. Spacious main compartment for gear storage. Large vented end exterior helmet or boot storage compartment. (2) small exterior pockets and (4) interior pockets. Constructed from 600 D polyester duck fabric on the back and 900 D polyester duck fabric on the bottom. Clear business card/ID holder. Heavy duty SBS zippers. U-shaped zipper closure for easy accessibility. Shoulder strap for comfortable transportation. This is the perfect bag for tower climbers and at-height workers.

3005 - \$54.99



GME SUPPLY PREMIUM GEAR BAG

27.5" L, 12" W, 15.5" H. Spacious main compartment for gear storage. Large vented end exterior helmet or boot storage compartment. (2) small exterior pockets and (4) interior pockets. Constructed from 600 D polyester duck fabric on the back and 1,680 D polyester duck fabric on the bottom. Clear business card/ID holder. Heavy duty SBS zippers. U-shaped zipper closure for easy accessibility. Shoulder strap for comfortable transportation. This gear bag features extra padding in the side lining for added equipment protection. This additional padding allows the bag to stand up on its own. It has a clear business card/ID holder, heavy-duty SBS zippers to withstand the toughest job sites, and a shoulder strap for easy, comfortable transportation. The opening of the bag has a 'U' shape opening instead of a traditional straight zipper, which allows you to unzip and access your gear with ease. This is the perfect bag for tower climbers and at-height workers. Not only does it have plenty of space to fit the gear you need, but the compartments help you keep your gear organized and separate. The job site can be hectic, but the GME Supply Premium Gear Bag can make sure that finding and transporting your equipment doesn't have to be.

3010 - \$74.99

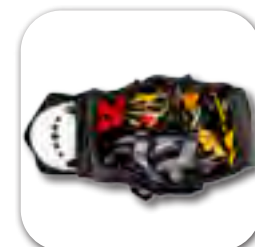

Holds a complete tower kit and more





ARSENAL 5005 LARGE F & R GEAR BAG

30" L, 15" W, 15" H. 1,000 D nylon. Double-coated polyurethane. Maltese cross heavy duty #10 zippers. 2" webbing handle and shoulder straps. Grab 'n Go pull strap and removable shoulder strap.
13305 - \$66.99



FOX OUTDOOR JUMBO GEAR BAG / BACKPACK

35" L, 13" W, 14" H. Rugged tactical polyester. (4) interior mesh pockets. Concealed shoulder straps. (2) end pockets with fitted storm flaps and zippered closure.
54-697 Army digital - \$63.99
54-690 Olive drab - \$63.99
54-691 Black - \$63.99



ARSENAL 5020 DUFFEL BAG

28.5" L, 13" W, 13" H. 600 D polyester with PVC backing. Heavy-duty ribbed straps top and side. #8 zippers. (2) end zipper pockets. Available in black and red.
13320 S - \$22.99
13321 M - \$24.99
13322 L - \$28.99



PMI RIGGERS BAG

24" L, 11" W, 12" H. Jumbo main compartment. (6) zippered compartments. 1,000 D heavy coated Cordura. Detachable shoulder strap. Padded handles. Clear ID holder.
RB44031 - \$96.00



KLEIN TOOLS PRO ORGANIZER BACKPACK

14" L, 7" W, 18" H. 39 pockets for tool storage. Hard molded front pocket protects safety glasses. Front zipper pocket for small parts and tools. Taller bag and interior pockets allow for long screwdrivers. Fully molded bottom protects from elements. Orange interior for easy tool visibility. 1,680 D ballistic weave for durability. Shoulder straps with extra padding and handles for easy carrying.
55421BP14 Black - \$96.99
55421BP14CAMO Camo - \$99.99



ARSENAL WATER RESISTANT DUFFEL

Water resistant tarpaulin material with 1,000 D polyester mesh. Shoulder straps configured to carry as duffel or backpack. Open design for maximum storage capacity. Interior mesh pocket under flap. (4) compression straps and (2) haul handles. ID and document pockets on top of bag.
5030S S (24" L, 15" W, 15" H) - \$92.99
5030M M (28" L, 17" W, 17" H) - \$103.99
5030L L (32" L, 19" W, 19" H) - \$124.99



KLEIN TOOLS EXTRA-LARGE GEAR BAG

24" L, 10" W, 18" H. Orange vinyl-coated nylon fabric bag. Bottom reinforced with 1/4" (6 mm) plywood. Nylon-web handles extend around bag for extra support. Extra flap for storm protection.
5180 - \$116.99



KLEIN TOOLS TRADESMAN PRO EXTREME BAG

17.5" L, 14" W, 10" H. 78 pockets for extreme tool storage. Lock bars keep bag propped open. Hard molded pocket protects tools, meters and tech devices. Wide center with removable pockets for easy access to tools. Fully molded bottom protects from the elements. 1,680 D ballistic weave for durability.
5541718-14 - \$170.99



ARSENAL LARGE WHEELED GEAR BAG

30" L, 14" W, 14" H. 600 D polyester main material. 1680 D polyester base. Molded wheels for safe and easy transport. (3) removable internal dividers for organization. Molded retractable pull handle. Padded and adjustable shoulder strap. Heavy-gauge nylon stitching and heavy-duty zippers. Material backing provides water protection.
5120 - \$122.99





ARSENAL 5517 ZIPPER TOOL POUCH

10" L, 6" W, 11.5" H, holds up to 5 lbs. 1680 D ballistic polyester is abrasion resistant. Accommodates a variety of hand tools. YKK zipper closure on top for extra security. (2) exterior and interior D-rings for attachments. (2) tool loops for holstering larger tools. (8) interior tool slots for organization. Interior fleece-lined pocket for cell phones. Nickel-plated storm drain. Modular buckle connection system on back for easy attachment and removal to fall protection harnesses and tool belts. Bright orange interior fabric makes finding and seeing contents easy.

13647 - \$52.99



ARSENAL 5527 HINGE TOOL POUCH

10" L, 6" W, 11.5" H, holds up to 20 lbs. 1680 D ballistic polyester is abrasion resistant. Accommodates a variety of tools. (2) exterior and interior D-rings for attachments. (2) tool loops for holstering larger tools. (8) interior tool slots for organization. Interior fleece-lined pocket for cell phones. Nickel-plated storm drain. Modular buckle connection system on back for easy attachment and removal to fall protection harnesses and tool belts. Bright orange interior fabric makes finding and seeing contents easy.

13627 - \$48.99



ARSENAL 5516 TOPPED TOOL POUCH, STRAP ATTACHMENT

11" L, 4.5" W, 11" H, holds up to 33 lbs. 1680 D ballistic Polyester. (16) pockets for tools and fasteners. Top cover flap with buckle closure. (3) nickel-plated D-rings for tool tether attachment. Storm Drains. Abrasion-resistant reinforced pouch bases.

13640 - \$44.99



ARSENAL 5550 PADDED BASE LAYER TOOL BELT

1680 D ballistic polyester. Thick, vented foam padding for comfort. Nickel-plated 2" double tongue metal roller buckle. Nickel-plated grommets set firmly for durability. Nickel-plated suspender anchors.

13653 L (3") - \$21.99

13654 XL (3") - \$21.99

13655 2XL (3") - \$21.99

13656 M (5") - \$26.99

13657 L (5") - \$26.99

13658 XL (5") - \$26.99

13659 2XL (5") - \$26.99



ARSENAL 5561 TOOL / RADIO HOLSTER

4.5" L, 2.5" W, 8.5" H, holds up to 5 lbs. 1680 D ballistic polyester is abrasion resistant. Holds a variety of tools. (2) exterior D-rings for tool tether attachment. Elastic strap with modular buckle closure secures contents of the holster. Modular buckle connection system on back for easy attachment and removal to fall protection harnesses and tool belts. Reflective strip for safety and visibility. Nickel-plated storm drain for ventilation. Third-party certified to a 2:1 (dynamic) and 5:1 (static) safety factor.

13561 - \$18.99



ARSENAL 5562 HAMMER HOLSTER

6" L, 3" W, 8" H, holds up to 5 lbs. 1680 D ballistic polyester is abrasion resistant. Holds most styles and sizes of hammers. (2) exterior D-rings for tool tether attachment. Open rubber dipped iron hammer holder allows for easy holstering of hammers with tool tethers on them. Modular buckle connection system on back for easy attachment and removal to fall protection harnesses and tool belts. Reflective strip for safety and visibility. Third-party certified to a 2:1 (dynamic) and 5:1 (static) safety factor.

13662 - \$17.99



ARSENAL 5563 POWER TOOL HOLSTER

8" L, 2.5" W, 12" H, holds up to 5 lbs. 1680 D ballistic polyester is abrasion resistant. Holds power drills and impact drivers by hanging the handle of tool on articulating iron hook. (2) exterior D-rings for tool tether attachment. Articulating hook lays flat against holster platform for low profile when not in use. Modular buckle connection system on back for easy attachment and removal to fall protection harnesses and tool belts. Reflective strip for safety and visibility. Third-party certified to a 2:1 (dynamic) and 5:1 (static) safety factor.

13563 - \$17.99





DAX FIFTY 50 CARBON FIBER FULL BRIM HARD HAT

Fiber reinforced resin shell for superior impact protection. Perforated Clarino synthetic leather comfort dome with molded EVA foam insert. 6-point suspension. Triple reinforced crown for protection. Each hard hat carbon fiber shell is hand laid giving it a unique, one of a kind appearance. ANSI compliant. Non-vented Type I Class C or C&G.

- HDF50C-19GB Green/Black - \$156.00
- HDF50C-19OC Orange/Black - \$156.00
- HDF50C-19HC Yellow/Black - \$156.00
- HDF50C-19WC White/Black - \$156.00



DAX COMPOSITE NON-VENTED FULL BRIM HARD HAT

Fiber reinforced resin shell for superior impact protection. Perforated Clarino synthetic leather comfort dome with molded EVA foam insert. 6-point suspension. Triple reinforced crown for protection. ANSI compliant. Non-vented Type I Class C or C&G.

- HDF-15KG Black - \$89.99
- HDF-15NG Natural - \$89.99
- HDF-18OG Orange - \$89.99
- HDF-18HV Hi-viz - \$89.99
- HDF-15WG White - \$89.99



DAX FIFTY 50 CARBON FIBER CAP

Fiber reinforced resin shell for superior impact protection. Perforated Clarino synthetic leather comfort dome with molded EVA foam insert. 6-point suspension. Triple reinforced crown for protection. Each hard hat carbon fiber shell is hand laid giving it a unique, one of a kind appearance. ANSI compliant. Non-vented Type I Class C.

- HDC50C-20GC Green/Black - \$150.00
- HDC50C-19OC Orange/Black - \$137.00
- HDC50C-19HC Yellow/Black - \$137.00
- HDC50C-19WC White/Black - \$137.00



DAX CARBON FIBER NON-VENTED FULL BRIM HARD HAT

Fiber reinforced resin shell for impact protection. Features a perforated Clarino synthetic leather comfort dome with a molded EVA foam insert for added shock absorbing protection. 6-point suspension. Triple reinforced crown for protection.

- HDFM-17KG Matte - \$135.00
- HDC-15KG Gloss - \$135.00



DAX COMPOSITE NON-VENTED CAP STYLE HARD HAT

Fiber reinforced resin shell for superior impact protection. 6-point suspension. Triple reinforced crown for protection. ANSI compliant. Non-vented Type I Class C or C&G.

- HDFC-17WG White - \$80.00
- HDFC-17KG Black - \$80.00
- HDFC-17NG Natural - \$80.00
- HDFC-18OG Orange - \$80.00
- HDFC-18HV Hi-viz - \$80.00



KONG MOUSE VISOR
 Helmet visor made of high quality polycarbonate. Extremely robust and resistant to ultraviolet rays, corrosion and fogging. ANSI compliant. Available in transparent and smoke.
 997056F00KK Smoked - \$59.99
 997056P00KK Transparent - \$55.99



KONG MOUSE FULL FACE VISOR
 Helmet visor made of high quality polycarbonate. Extremely robust and resistant to ultraviolet rays, corrosion and fogging. ANSI compliant.
 997046P00KK Transparent - \$79.99



KONG HEADPHONES
 Noise reduction 3M Peltor headphones available in 3 versions with different levels of acoustic insulation. ANSI compliant.
 999130000KK Red, 32 dB - \$54.99
 999140000KK Yellow, 30 dB - \$49.99
 999160000KK Green, 26 dB - \$32.99



LIFT SAFETY NECK SHADE
 Attaches to most hard hats relieving, not only your neck from damages from the sun, but also uses cooling membranes that help regulate core body temperatures. Simply submerge fabric in cold water for 1-2 minutes, remove excess liquid, and wear for hours of comfort.
 ACC-14K Crown cooler neck shade - \$14.99
 ANS-14K Neck shade - \$12.99





MSA SKULLGARD FULL BRIM NON-VENTED HARD HAT

Heavy-duty construction for use in steel mills and other heavy industries where elevated temperatures are common. Resin shell with 4-point Fas-Trac ratcheting suspension. Fits head sizes 6-8. Cap style Type I Class G. ANSI compliant.

475407 Full brim - \$94.99

475395 Cap style - \$89.99



MSA V-GARD DIGITAL CAMOUFLAGE CAP STYLE NON-VENTED HARD HAT

Fas-Trac 4-point suspension includes ratcheting system and perforated vinyl sweatband. Polyethylene shell. Top impact protection. Full brim Type I Class E. ANSI compliant.

10103908 Cap style - \$31.99

10104254 Full brim - \$32.99



MSA V-GARD FULL BRIM NON-VENTED HARD HAT

Fas-Trac 4-point suspension includes ratcheting system and perforated vinyl sweatband, polyethylene shell, top impact protection, ANSI compliant. Available in red, blue, green, yellow, orange, hi-vis orange, and white.

475310 - \$19.99

MSA NEXUS HEIGHTMASTER VENTED HELMET

Non-contact foam liner provides shock and penetration protection. Fully removable and adjustable 4-point chinstrap. ANSI compliant. Available in red, blue, green, yellow, hi-vis yellow, and white.

10186489 White - \$140.99



MSA V-GARD NON-VENTED HARD HAT CAP STYLE

Fas-Trac 4-point suspension includes ratcheting system and perforated vinyl sweatband, polyethylene shell, top impact protection, ANSI compliant. Available in red, blue, green, yellow, orange, hi-vis orange, and white.

475358 - \$14.99



MSA HARD HAT CHIN STRAP

Chin strap attaches to shell. For use with MSA V-Gard and Topgard hats. Contains no metal. 2 point, 3/4" polyester webbing.

10171104 - \$5.99



ADAPTER VISOR BRACKETS

Dielectric and features a retention band to reduce movement while attached. Universal pegs that can accommodate a wide variety of face shields and fits most hard hats.

HG-410A4 Half brim - \$6.49

HG-410-A4F Full brim - \$7.99



CHILL-ITS HARD HAT BRIM WITH SHADE

Fits around the outside of the hard hat. Provides sun/UV protection. Universal design fits most hard hats. Available in lime or orange.

6660 - \$9.99



ERGODYNE SQUIDS HARD HAT LANYARD

Comfortably attaches to hard hats and other head wear. Double lock plastic buckle. Comfortable high stretch elastic material.

3150 - \$4.99



ERGODYNE CHILL-ITS TERRY SWEATBAND

Absorbent terry headband. Fits most hard hat suspension systems. Machine washable, 100% cotton. Economical way for hard hat wearers to manage moisture.

6609 - \$5.49



SAFETY HELMETS 101

OSHA states that a safety helmet must be worn “when working in areas where there is potential for injury to the head from falling objects.” Hard hats must also be worn in areas where there’s a risk of exposure to electrical conductors that can potentially contact the head. In these situations, specially designed helmets must be used.

HARD HAT TYPES



TYPE I: Type I hard hats are intended to reduce forces of impact from a blow to the top of the head. These are the most common helmet on the jobsite. Type 1 helmets would protect a worker from a dropped hammer or tape measure.

TYPE II: Type II hard hats are intended to reduce forces from lateral impact coming from an off-center, side, or top of the head strike. This impact could be from a sharp corner of an I-Beam or swinging structural element of a tower. The sides of these helmets are typically lined with a high-density foam or suspension.

ELECTRICAL CLASSES



CLASS E: Class E hard hats are designed to reduce exposure to high voltage conductors and offer protection up to 20,000 volts. These helmets cannot be vented. Formerly associated with the “Class B” rating, Class E hard hats can also be considered a General, “Class G” hard hat.

CLASS G: Class G hard hats are designed to reduce exposure to low voltage conductors. They offer protection up to 2,200 volts. Like Class E helmets, this protection is only for the head. Class G was formerly categorized as “Class A”.

CLASS C: Class C hard hats are considered conductive, and they do not provide any electrical protection. These helmets are typically vented, and only protect workers from impacts but do provide workers increased breathability.

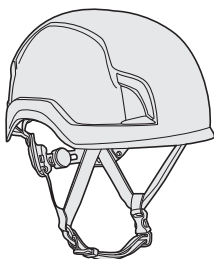

NON-VENTED

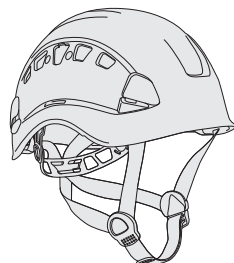

VENTED

LABELING

To qualify as an ANSI certified helmet, there must be a legible label inside the helmet which identifies the standards that the hard hat was designed to meet. If your helmet is missing this label or it’s no longer legible, it should be replaced.

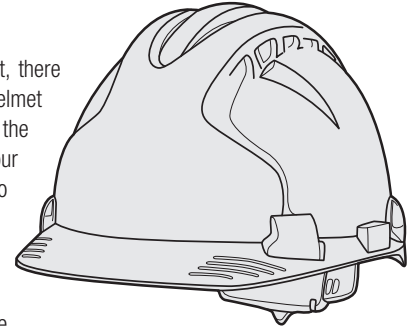

SERVICE LIFE

Hard hats service life starts from the time it was put into service. While there is a date code stamped into the helmet, that is only the date of manufacturing. When a helmet is put into service, it should be documented on the label in the shell of the hard hat.

The helmet suspension should be replaced after no more than every 12 months, and the helmet should be replaced after no more than 5 years. These dates are the maximum, and the helmet should be inspected regularly to ensure that it is still safe.

If the hard hat has sustained an impact it must be removed from service. Even if there is not visible damage, the materials could have weakened and may no longer provide the safe level of protection required.

BEST PRACTICES

Suspensions should always be designed by the manufacturer to work with the specific hard hat and should not be modified. Only use the specific suspension when replacing a worn out suspension and install it to the manufacturer’s instructions. This includes installing it backwards so the brim of a helmet can be worn in the back. Although, some manufacturers do offer swing-style suspensions which allow the helmet to be reversed.

Do not paint your helmet. Chemicals in the paint can alter and damage the structure of the hard hat and reduce the protection provided. If you’re painting on the jobsite, always clean your helmet according to the manufacturer’s recommendations to remove any chemicals or paint residue that may be present.

Pressure sensitive, non-metallic stickers or self-adhesive tape are typically acceptable on most of today’s hard hats. However, you must refer to the manufacturer’s recommendation to verify if they’re allowed on your particular hard hat and for placement guidelines.

STANDARDS

ANSI/ISEA Z89.1-2014

This standard provides performance and testing requirements for industrial helmets, commonly known as hard hats. It establishes the types and classes of protective helmets, depending on the type of hazard encountered.

OSHA 29 CFR 1910.135

Head Protection Requirements and Classifications of Hard Hats and Safety Helmets for general industry workers.

OSHA 29 CFR 1926.100

Head Protection Requirements and Classifications for head protection for construction, demolition, and renovation workers.





**PETZL STRATO
HIGH PERFORMANCE
VENTED HELMET**

Ventilation holes. Features two adjustment systems: Centerfit and Flip&Fit system adjustment. Dual chinstrap which is adjustable to strengthen it to whether you're working at height or on the ground. Accessories to customize to you and modular for easy install. ANSI compliant.

- A020BA00 White - \$124.95
- A020BA02 Red - \$124.95
- A020BA01 Yellow - \$124.95
- A020BA03 Black - \$124.95
- A020DA01 Hi-Viz Yellow - \$134.95
- A020DA00 Hi-Viz Orange - \$134.95



**PETZL STRATO
HIGH PERFORMANCE
NON-VENTED HELMET**

Unventilated shell ensures protection against electrical risks and molten metal splash. Features two adjustment systems: Centerfit and Flip&Fit system adjustment. ANSI compliant. Available in White, Red, Yellow, Black, Hi-Viz Yellow and Hi-Viz Orange.

- A020AA00 White - \$124.95
- A020CA00 Hi-Viz Yellow - \$134.95
- A020CA01 Hi-Viz Orange - \$134.95



**PETZL VERTEX
NON-VENTED HELMET
2019 MODEL**

Unventilated shell ensures protection against electrical risks and molten metal splash. Features two adjustment systems: Centerfit and Flip&Fit system adjustment. ANSI compliant. Available in White, Red, Orange, Yellow, Green, Blue, Black, Hi-Viz Yellow and Hi-Viz Orange.

- A010AA00 White - \$99.95
- A010DA00 Hi-Viz Yellow - \$109.95
- A010DA01 Hi-Viz Orange - \$109.95



**PETZL VERTEX VENTED
HELMET - 2019 MODEL**

Ventilation holes with adjustable sliding shutters allow air to circulate in the helmet when needed. Features two adjustment systems: Centerfit and Flip&Fit system adjustment. Dual chinstrap which is adjustable to strengthen it to whether you're working at height or on the ground. Accessories to customize to you and modular for easy install. ANSI compliant.

- A010CA00 White - \$99.95
- A010CA02 Red - \$99.95
- A010CA04 Orange - \$99.95
- A010CA01 Yellow - \$99.95
- A010CA06 Green - \$99.95
- A010CA05 Blue - \$99.95
- A010CA03 Black - \$99.95
- A010EA00 Hi-Viz Yellow - \$109.95
- A010EA01 Hi-Viz Orange - \$109.95

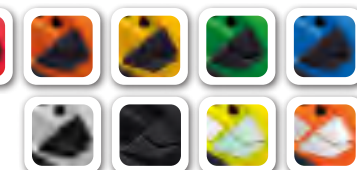

PETZL VIZEN FACE SHIELD

Easy to mount on Vertex and Alveo helmets, ultra-wrap shield completely protects face against dangers of an electric arc, (2) positions: raised on top of helmet, lowered in working position, scratch / fog resistant, ANSI compliant.

- A14 - \$69.95



**PETZL VIZIR
FACE SHIELD**

Easy to mount on Vertex and Alveo helmets, (2) positions: raised on top of helmet, lowered in working position, scratch / fog resistant, ANSI compliant.

- A15A Clear - \$59.95
- A15AS Shadow tinted - \$64.95



**PETZL
ABSORBENT
FOAM**

Comfort foam absorbs perspiration and is machine washable.

- A10200 Vertex - \$11.95
- A20200 Alveo - \$11.95



**PETZL
REPLACEMENT
FOAM**

Regular foam for most head sizes and thick foam for smaller head sizes, easy maintenance.

- A10210 Vertex - \$8.95
- A20210 Alveo - \$8.95



**PETZL
REFLECTIVE
STICKERS**

(4) pre-cut reflective stickers for increased visibility.

- A10110 Vertex - \$11.95
- A20110 Alveo - \$11.95





KASK ZENITH NON-VENTED HELMET

High density ABS plastic outer shell. Polystyrene inner shell. PA soft nylon headband. External lamp clips. Fast3Dry fabric for quick absorption of moisture. ANSI compliant. Available in white, red, orange, pink, yellow, blue, black.

WHE00031.208 Blue - \$129.95



GO TO WWW.GMESUPPLY.COM/PPE TO VIEW ALL PERSONAL SAFETY GEAR



KASK SUPERPLASMA HD VENTED HELMET

High density ABS Plastic outer shell. Polystyrene inner shell. (10) vents for maximum airflow. High-tech fabric 2DRY for quick absorption of moisture. Removable and washable padding. Fully adjustable width and height. Anti-intrusion grill on helmet vents prevents entry of debris. ANSI compliant.

WHE00036.201 White - \$129.99

WHE00036.204 Red - \$129.99

WHE00036.203 Orange - \$129.99

WHE00036.202 Yellow - \$129.99

WHE00036.208 Blue - \$129.99

WHE00036.210 Black - \$129.99



KASK ZENITH COMBO NON-VENTED HELMET

High density ABS plastic outer shell. HD polystyrene inner shell. PA soft nylon headband. Electric shocks protection. Ring to hook. Includes Zen visor attachment, luminescent clips, reflective stickers, and earmuffs. Removable front pad. Fast3Dry fabric for quick absorption of moisture. ANSI compliant. Available in white, black, orange, hi-viz yellow, and hi-viz lime.

WHE00026.210 Black - \$284.95



KASK SUPERPLASMA HD HI VIZ VENTED HELMET

High density ABS Plastic outer shell. Polystyrene inner shell. Hi visibility luminescent clips and reflective stickers. (10) vents for maximum airflow. High-tech fabric 2DRY for quick absorption of moisture. Removable and washable padding. Fully adjustable width and height. Anti-intrusion grill on helmet vents prevents entry of debris. ANSI compliant.

WHE00037.201 Hi-viz white - \$139.99

WHE00037.221 Hi-viz yellow - \$139.99

WHE00037.223 Hi-viz red - \$139.99

WHE00037.224 Hi-viz lime - \$139.99



KASK ZENITH ZEN VISOR

Made from polycarbonate material, scratch / fog resistant panoramic lens, cut proof edge, rubber drip proof upper contour, ANSI rated.

WV100007.015 Clear - \$59.95



KASK ADAPTER SET FOR ZENITH VISORS

Installed directly onto Zenith helmets so that Zen Visors can be attached. This set is required for installing visor.

WAC00009.000 - \$24.95



KASK SUPERPLASMA V2 VISOR

Made from polycarbonate material, scratch / fog resistant panoramic lens, cut proof edge, rubber drip proof upper contour, ANSI rated.

WV100002.015 Clear - \$55.95

WV100002.009 Smoke - \$65.95

WV100002.055 Silver mirror - \$75.95



KASK SILVER REFLECTIVE STICKERS

Pre-cut reflective stickers for better visibility.

WAC00001 Superplasma - \$19.99

WAC00014 Zenith - \$26.99



KASK INNER PADDING

Replacement padding for helmets. Sweatband and inner crown pieces attach directly to helmet.

WPA00003 Superplasma - \$19.99

WPA00006.000 Zenith - \$24.99





NEW
ANSI Z89.1
TYPE I VIDEO



3M SECUREFIT X5000 SERIES SAFETY HELMET

3M Pressure Diffusion technology in the suspension increases comfort and security. Pressure diffusion reduces the force on your forehead up to 20% compared to the conventional 3M helmet suspension. There are 15 adjustment settings that allow for different height and front to back adjustments. The brimless design allows you to have a better awareness of hazards. A smooth, turning ratchet suspension system makes headband adjustments quick and easy. The helmet suspension sits low on the head to reduce pressure and increase comfort and security. A UVicator sensor installed on your helmet changes color from red to white as it's exposed to ultraviolet (UV) light to signify when you should replace your helmet. Accessory slots and clips on the helmet work with a variety of 3M accessories. Optional vents are designed to allow airflow through the helmet. The SecureFit Safety Helmet has eight color options and optional reflective material.

X5001V-ANSI Vented - \$84.99

X5001-ANSI Non-vented - \$84.99

ANSI Z89.1
TYPE I CLASS C QUICK SHIP VIDEO



JSP DELUXE WHEEL RATCHET VENTED HARD HAT

High-density polyethylene shell, 6-point textile cradle suspension, 3D precision fitting, Revolution wheel ratchet adjustment, Chamlon sweatband with Egyptian cotton core and porous PU coating for maximum sweat absorption, universal accessory slots, chin strap, firmest fit available, short brim, ANSI compliant. Available in white, red, yellow, orange, and blue; vented or non-vented. Non-vented Type I Class E.

TW6151SV Vented - \$49.99

TW6151S Non-vented - \$49.99

ANSI Z89.1
TYPE II CLASS E



JSP MK8 EVOLUTION NON-VENTED HARD HAT

Side impact and penetration protection. Polystyrene impact liner. High-density polyethylene shell. Strap suspension with micro fiber crown pad. Wheel ratchet adjustment. Available in vented or non-vented. Vented Type I Class C. ANSI compliant.

AHS150-10 Non-vented - \$49.99

AHS150-10V Vented - \$51.99

AHS240-10 Non-vented with 4-point chin strap - \$60.99

AHS240-10V Vented with 4-point chin strap - \$61.99

ANSI Z89.1
TYPE I CLASS C

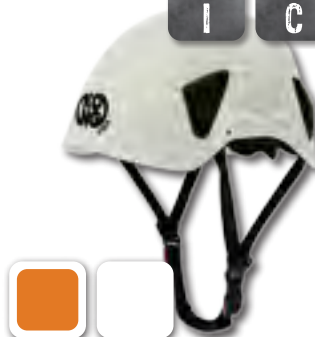

KONG FINN NON-VENTED HELMET

External shell made from advanced thermo material. Inner shell made from Polystyrene. Features up and down adjustable size system. Removable headband. Slots for ear protectors. Quick release buckle. Adjustable and removable chin strap. Headlamp clips. ANSI compliant. Available in white and orange.

99707AW00KK White - \$94.00



JSP RETRACTABLE SAFETY GLASSES

Clear polycarbonate 6-base curved lens, can be fully retracted into helmet shell, anti-fog and scratch resistant coatings, compatible with any JSP Deluxe 6100 helmet.

250-EVS-0000 - \$9.99

JSP REFLECTIVE STICKERS

This sticker kit gives full brim hard hats 360° reflective coverage. (7) pre-cut stickers.

281-CR2FB-10 Full brim - \$38.99

281-CR2-10 Cap style - \$45.99

JSP CHIN STRAPS

Helps keep hats and caps stable on the worker's head. Attaches directly to hard hat. Adjustable. Great for work at-height.

281-CS-2PT 2-Point standard - \$5.19

281-CSD-2PT 2-Point deluxe - \$6.19

281-CS-4PT 4-point - \$10.99

MSA V-GARD FRAME FOR SLOTTED CAPS

Sloped design allows liquids, chips, and other materials to slide off frame and away from sight, ANSI compliant.

10115730 - \$10.99

10117750 Polycarbonate visor - \$5.99

MSA REPLACEMENT SUSPENSION

Ratcheting suspension liner includes headband, nape strap, sweatband, and crown straps; Designed for the V-Gard hat or cap shell.

10148708 For Fas-trac - \$12.99

10153385 For Skullgard - \$16.99





ANSI Z89.1 TYPE I
ANSI Z89.1 CLASS E
CSA COMPLIANT



PYRAMEX RIDGELINE FULL BRIM STYLE NON-VENTED HARD HAT

Made from ABS material. Ratchet suspension is easy to adjust and allows the wearer to modify the fit while wearing hard hat. Soft brow pad, suspensions, and headbands are replaceable. 4-point suspensions can be converted to a 6-point suspension. ANSI and CSA compliant. Available in matte camo, shiny white graphite, matte black graphite, and blue.

HP54119 Matte camo - \$26.99

ANSI Z89.1 TYPE I
ANSI Z89.1 CLASS E
CSA COMPLIANT



PYRAMEX RIDGELINE CAP STYLE NON-VENTED HARD HAT

Made from ABS material. Low profile design offers a low center of gravity for better balance. Rear padded suspension. 4-position harness points. Replaceable sweat band. Vented pressure pad. Easy to grasp knob. Swinging hinge points. ANSI compliant. Available in matte camo, blue, matte white graphite, shiny white graphite, matte black graphite, and shiny black graphite.

HP44119 Matte camo - \$25.99



NEW
ANSI Z89.1 TYPE I
ANSI Z89.1 CLASS G

PMI STRIKEFORCE

Aggressive-looking helmet has a solid black matte finish without any visible logos. Fully adjustable and 3-point chinstrap. Headlamp retainer, goggle mount, clips to attach earmuffs. ANSI compliant.

HL33035SF - \$215.00



ANSI Z89.1 TYPE I
ANSI Z89.1 CLASS G

PMI ADVANTAGE NFPA NON-VENTED HELMET

Made of Kevlar. Fully adjustable ratchet headband and 3-point chinstrap. Headlamp retainer, goggle mount, clips to attach earmuffs. ANSI compliant. Available in red, orange, lime green, blue, white, and matte black.

HL33012 - \$190.25



GEAR EXPERTS®

“ If you’re working in the elements or require an NFPA certification on your helmet, the Advantage might just be the helmet for you. The more pronounced brim on the front will play a key role if you’re working in an environment where rain or spray will be a factor. Many of our partners prefer this helmet for technical rescue incidents, reach out to our team if you have any questions! ”



JUSTIN KRAFT
International & Government Sales Manager



PYRAMEX RIDGELINE FULL BRIM REPLACEMENT SUSPENSION

4-point replacement suspension for all Ridgeline full brim hard hats.

HPR541 4-point - \$8.99



PYRAMEX RIDGELINE CAP STYLE REPLACEMENT SUSPENSION

Replacement suspension for all Ridgeline cap style hard hats.

HPR441 4-point - \$8.99

HPR461 6-point - \$8.99

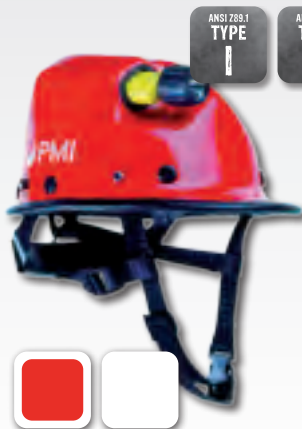

ANSI Z89.1 TYPE I
ANSI Z89.1 TYPE II
ANSI Z89.1 CLASS G



PMI POD NON-VENTED HELMET

Excellent for vertical work and confined space operations, the PMI Pod helmet is versatile, lightweight, and features a built in light pod that accepts the intrinsically safe UK4AA Light. 3-point chinstrap. Goggle mount. ANSI compliant. Available in red and white.

HL33025 Red - \$195.99





MUTED UNMARKED
MATTE BLACK FINISH ▶



STRIKEFORCE BLACKOUT HELMET

- Fully Adjustable
- Three-Point Chinstrap
- Headlamp Retainer
- Goggle Mount
- Clips to Attach Earmuffs



X-LARGE ROPE PACK



EXTREME PRO ROPE



LIGHTWEIGHT RAPPEL GLOVES



(706) 764-1437 | pmirope.com

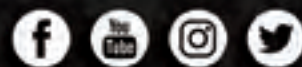



PETZL PIXA 2 HEADLAMP

80 lms. Can be worn on the head with the headband, attached to the helmet with a mounting plate, or placed on the ground. Constant lighting technology ensures brightness that does not gradually decrease as the battery drains. (2) lighting modes adapt to each situation: close-range work and movement. Excellent resistance to falls (2 m), impacts, and crushing (80 kg). Comfortable and washable elastic headband. Resistant to chemicals and can be used in explosive environments. Mixed beam pattern. Uses (2) 2 AA batteries. IP67 waterproof to -1 meter for 30 minutes.

E78BHB 2UL - \$59.95



PETZL PIXA 3 HEADLAMP

100 lms. Can be worn on the head with the headband, attached to the helmet with a mounting plate, or placed on the ground. Constant lighting technology ensures brightness that does not gradually decrease as the battery drains. (3) lighting modes adapt to each situation: close-range work, movement, and long-range vision. Excellent resistance to falls (2 m), impacts, and crushing (80 kg). Comfortable and washable elastic headband. Resistant to chemicals and can be used in explosive environments. Flood, mixed and focused beam patterns. Uses (2) AA batteries. IP67 waterproof to -1 meter for 30 minutes.

E78CHB 2UL - \$79.95



PETZL PIXA 3R HEADLAMP

90 lms. Can be worn on the head with the headband, attached to the helmet with a mounting plate, or placed on the ground. Constant lighting technology ensures brightness that does not gradually decrease as the battery drains. (3) lighting modes adapt to each situation: close-range work, movement, and long-range vision. Excellent resistance to falls (2 m), impacts, and crushing (80 kg). Comfortable and washable elastic headband. Resistant to chemicals and can be used in explosive environments. Flood, mixed and focused beam patterns. Rechargeable Lithium-Ion polymer batter, 930 mAh. IP67 waterproof to -1 meter for 30 minutes.

E78CHR 2 - \$139.95



PETZL TIKKA CLASSIC HEADLAMP

200 lms. Long burn time. Mixed beam pattern. Uses (3) AAA or Core rechargeable battery. IPX4 weather resistant. Continuous red light combines visual comfort and stealth; red strobe light. Headband can be undone for easy donning. Several lighting modes suitable for different situations, from proximity lighting to rapid movement. Available in black, green, red, and blue.

E93AAA - \$29.95



PETZL TACTIKKA HEADLAMP

200 lms. Long burn time. Continuous red light combines visual comfort and stealth; red strobe light. Headband can be undone for easy donning. (2) lighting modes adapt to each situation: close-range work and movement. Wide beam pattern. Uses (3) AAA batteries or Core rechargeable battery. IPX4 weather resistant. Available in black and camouflage.

E93ACA - \$29.95



PETZL ACTIK HEADLAMP

300 lms. Long burn time. Red lighting preserves night vision and keeps from blinding other members of the group. Reflective headband helps you to be seen when a light is shone on it, and is equipped with an emergency whistle for rescue situations. (3) lighting modes adapt to each situation: close-range work, movement, and long-range vision. Wide or mixed beam pattern. Uses (3) AAA batteries or Core rechargeable battery. IPX4 weather resistant. Available in black, green, and blue.

E99AAA - \$49.95



RAYOVAC WORKHORSE PRO HEADLIGHT

50 lms. High performance LEDs. Rubber body with shock absorbers for durability. Impact resisting internal engineering. IPX4 water resistant. Cloth and silicone head-straps included. 2 modes: 50 lms, 21 lms (energy saver). Beam distance: 30 m, 17 m (energy saver). (3) AAA Rayovac alkaline batteries included. Battery run time: 17 hours, 38 hours (energy saver). 30' drop test performance.

620-DIYHL3AAA-B - \$11.98



STREAMLIGHT DOUBLE CLUTCH USB HEADLAMP

125 lms. Flexibility of shifting between beams and modes to fit your task, as well as choosing your battery source. Use even with gloves, just a quick twist of the facecap turns the light on and off, or changes the output from spot to flood.

61602 - \$56.99



MSA SOUND CONTROL SH EAR MUFFS

Spring design offers low pressure with high level comfort. Three wearing positions for ease of use. Excellent grip makes it easy to adjust the cups. Soft ear cup material for extended wear.

10129327 NRR 25, slotted - \$39.99

10034487 NRR 25, non-slotted - \$49.99



CAP MOUNTED PASSIVE EAR MUFF

Soft cushions maintains a high level of comfort protection, color coding for easy selection and identification, smooth size adjustment.

263-42001 NRR 22 - \$12.99

263-42002 NRR 24 - \$16.99

263-42003 NRR 27 - \$19.99



KASK EAR MUFFS

Attachment to the helmet with a bayonet adapter. Universal 30 mm euro slot. Performance differentiated by color. Smooth telescopic size regulation. Non-conductive.

WHP00001.203 NRR 31, orange - \$32.95

WHP00001.202 NRR 26-30, yellow - \$29.95

WHP00001.205 NRR 26, green - \$24.95



HOWARD LEIGHT INNER-AURAL EAR PLUGS

Smooth, ergonomic pods fit in the ear for maximum protection; patented band design prevents ear pods from touching dirty or contaminated surfaces, lightweight and portable – includes pair of replacement pods. Designed for intermittent noise.

QB2HYG NRR 25 - \$40.99

QB200HYG Replacement pods - \$5.49

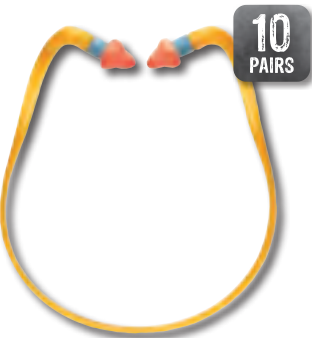

GME SUPPLY NEW HIRE PPE KIT

Kit includes JSP Comfort Plus Hard Hat, Bouton Zenon Safety Glasses with anti-fog gray lens and black temple, MaxiFlex Ultimate Nitrile Coated Nylon Gloves, Howard Leight SmartFit Reusable Ear plugs. Great for site visitors. **Customize your own kit.**

99001 - \$14.99



HOWARD LEIGHT MAX EAR PLUGS

Single-use, the world's most-used polyurethane foam earplug. Bell shaped for maximum in-ear comfort. Contoured design easier to insert, resists tendency to back-out of ear canal. Polyurethane foam enhances comfort, especially for long-term wear. Smooth, soil-resistant closed cell-foam skin prevents dirt build-up. NRR 33.

MAX-30 Corded - \$23.49



HOWARD LEIGHT MAX EAR PLUGS

Single-use, the world's most-used polyurethane foam earplug. Bell shaped for maximum in-ear comfort. NRR 33.

MAX-1 Uncorded - \$25.99

MAX-30 Corded - \$23.49



PIP DISPOSABLE FOAM EAR PLUGS

Soft, smooth polyurethane foam expands gradually for a secure comfortable seal. Tapered shape offers easy insertion and removal. Individually wrapped pairs. NRR 32 dB.

265-200U Uncorded - \$27.99

265-100C Corded - \$25.99



PIP DISPOSABLE FOAM EAR PLUGS

Disposable soft polyurethane foam. Tapered design fits natural contour of the ear canal. X-Emboss at end of the plug reduces pressure. NRR 30.

267-HPF300 Uncorded - \$21.99

267-HPF300C Corded - \$21.99



PIP DISPOSABLE FOAM EAR PLUGS

Disposable soft polyurethane foam, tapered design fits natural contour of the ear canal. X-Emboss at end of the plug reduces pressure. NRR 32.

267-HPF200 Uncorded - \$22.99

267-HPF200C Corded - \$19.99





250-47-0004



bouton
OPTICAL
a clear vision of safety

BOUTON SUNBURST

This "sun" collection offers polarized and mirror plus lenses featuring an AR treatment to eliminate reflection, lightweight, full frame design for all day comfort, bayonet temples are rubber co-molded for a secure fit, non-slip rubber nose pads provide a comfortable fit, 8 base curve lens, 99.99% UV protection, black frame, silver mirror lens, anti-scratch, anti-reflective, reduces glare up to 15% more than tinted lenses alone, ANSI compliant.

- 250-47-0004 Black frame, red mirror lens - \$10.49
- 250-47-0005 Black frame, silver mirror lens - \$10.49
- 250-47-0006 Black frame, blue mirror lens - \$10.49
- 250-47-0007 Black frame, gold mirror lens - \$10.49
- 250-47-0020 Black frame, clear lens - \$8.49
- 250-47-0021 Black frame, gray lens - \$8.49
- 250-47-0041 Black frame, polarized gray lens - \$29.99
- 250-47-1008 Brown frame, green mirror lens - \$10.49
- 250-47-1042 Brown frame, brown lens - \$29.99

* Discounted case packs available for all styles.
Additional lens options available in case packs.



SKULLERZ DAGR

Sleek half frame blade style safety glasses. Co-injection rubber temples and non-slip nose piece. Meet ANSI Z87.1, CSA Z94.3 + and MIL-PRF 32432 Ballistic Impact. Scratch-resistant lens blocks 99.9% of harmful UV. Sleek blade frame with co-injection rubber temples. Rubber nose pieces prevent slipping. Temple accessory slot also improves air flow.

- 52020 Black frame, copper lens - \$16.99
- 52021 Black frame, polarized copper lens - \$37.99
- 52030 Black frame, smoke lens - \$16.99
- 52033 Black frame, smoke lens with fog-off - \$22.99
- 52130 Matte gray frame, smoke lens - \$16.99
- 52320 Kryptek highlander frame, copper lens - \$24.99
- 52321 Kryptek highlander frame, polarized copper lens - \$49.99
- 52330 Kryptek highlander frame, smoke lens - \$24.99
- 52530 Kryptek typhon frame, smoke lens - \$24.99





250-AN-10115

BOUTON ANSER

Black frame, smoke lens, anti-scratch, semi-rimless design provides all day user comfort, sleek and sporty style with wraparound lens protection, bayonet temples with flexible rubber tips for comfortable and secure fit, soft rubber nose pads to keep glasses in place, adjustable neck cord, 9 base curve, 99.9% UV protection, ANSI compliant.

- 250-AN-10110 Black frame, clear lens - \$3.99
- 250-AN-10112 Black frame, gray lens - \$3.99
- 250-AN-10114 Black frame, I/O lens - \$4.19
- 250-AN-10115 Black frame, blue mirror lens - \$4.99
- 250-AN-10118 Black frame, IR Filter 3.0 lens - \$6.99
- 250-AN-10119 Black frame, IR Filter 5.0 lens - \$7.99
- 250-AN-10120 Black frame, amber lens - \$3.99
- 250-AN-10121 Camo frame, brown lens - \$6.99
- wt Camo frame, gray lens - \$6.99
- 250-AN-10125 Black frame, silver mirror lens - \$4.99

COMPARE TO NEMESIS



250-AN-10110

250-AN-10112

250-AN-10114

250-AN-10119

250-AN-10120

250-AN-10121

250-AN-10123

250-AN-10125



50030



50033



50242



50080



50320

SKULLERZ ODIN

Full frame safety glasses. Rubber co-injection temples and non-slip nose piece. Meet ANSI Z87.1+, CSA Z94.3 and MIL-PRF 32432 Ballistic Impact. Scratch-resistant lens blocks 99.9% of harmful UV. Full-frame design with co-injection rubber temples. Rubber nose pieces prevent slipping.

- 50030 Black frame, smoke lens - \$16.99
- 50033 Black frame, smoke lens with fog-off - \$21.99
- 50080 Black frame, indoor/outdoor lens - \$16.99
- 50092 Black frame, blue mirror lens - \$16.99
- 50133 Matte gray frame, smoke lens with fog-off - \$21.99
- 50242 White frame, silver mirror lens - \$16.99
- 50320 Kryptek highlander frame, copper lens - \$24.99
- 50430 Matte black frame, smoke lens - \$16.99
- 50530 Kryptek typhon frame, smoke lens - \$24.99



50092



50430



50133



50530



MORE COLORS



BOUTON COMMANDER

Gloss black frame, gray lens, anti-fog/anti-scratch, 9.5 base curve, bayonet style temples, adjustable rubber nose pads, ANSI compliant.

250-33-0021 - \$8.29

MORE COLORS & DIOPTERS



SAFETYGEAR ZENON Z12R READERS

28 mm wide reading magnifier, lightweight, rimless design; rubberized temples, gray rubber co-molded temples, molded nose bridge design, 9.25 base curve, +1.50 Diopter, ANSI compliant.

250-27-0115 - \$2.99

MORE COLORS & DIOPTERS



SAFETYGEAR MAG READERS

30 mm wide curved top reading magnifier, +2.00 diopter, durable nylon frame with extra wide bridge pads and soft temple pads for added comfort, 8 base curve, ANSI compliant.

250-25-0020 - \$4.99



MORE COLORS



BOUTON SCOUT OTG

Large frame that can be used alone or as an Over-The-Glass style to fit all personal eye wear, polycarbonate uni-lens, molded nose bridge design, indirect vent temples to reduce fogging, 4 base curve, ANSI compliant.

250-99-0900 - \$1.99

BOUTON BULLSEYE

Gray lens, lightweight, rimless design, flexible bayonet style temples provide a secure fit, molded nose bridge design to fit the vast majority of users, 9 base curve, anti-scratch/anti-fog coating, ANSI compliant.

250-31-0021 - \$4.99

MORE COLORS



BOUTON RECON

Gradient lens, lightweight, rimless design; rubber co-molded bayonet temples for a comfortable fit, non-slip rubber nose pads, anti-fog lens coating, anti-scratch, 10 base curve, ANSI compliant.

250-32-0031 - \$6.99



BOLLE NITRO

High contour lens with 180 degree distortion free viewing and superior optical quality, ultra-low profile design fits under hard hats, latex-free adjustable pivoting strap, anti-scratch/anti-fog, ANSI compliant.

40095 - \$19.99



**BOUTON 550
SOFT SIDES DIRECT VENT**

Provides protection from chips and flying particles, anti-scratch/anti-fog, direct side ventilation, soft vinyl body, fits over most prescription glasses, elastic headband, 99.9% UV protection, ANSI compliant.

248-5090-400B - \$3.95

MORE COLORS



BOLLE DUO

High impact double polycarbonate lens, anti-fog/anti-scratch, 99.99% UVA/UVB light absorption, 9 base curve, indirect lower vents, fog-free performance, TPR frame, adjustable strap, ANSI compliant.

40097 - \$31.99

MORE COLORS



BOLLE TRACKER

Protection from chemical and mechanical risks, upper and lower protection, removable foam reinforcement with indirect ventilation, removable adjustable strap, side ventilation, anti-scratch/anti-fog, ANSI compliant.

40085 - \$19.99

MORE COLORS



BOLLE ATOM

Extremely comfortable thermoplastic rubber (TPR) frame, overflow chute for liquids, ball-pivot, adjustable strap, fits over prescription glasses, anti-scratch/anti-fog, ANSI compliant.

40092 - \$17.49

MORE COLORS



BOUTON FUSELAGE

Clear lens, anti-scratch/anti-fog, temples and headband snap in/out to easily convert from safety glass to dust goggle, flame resistant soft foam padding, 8 base curve, 99.9% UV protection, ANSI compliant.

250-50-0420 - \$8.49



250-01-0000



SAFETYGEAR ZENON Z12

This popular style comes in a variety of different polycarbonate lenses to fit your application. Lightweight, rimless design provides all day user comfort. Thin, flexible temples provide a secure fit without uncomfortable pressure points. Molded nose bridge design to fit the vast majority of users. 9.5 Base curve lens. Meets ANSI Z87.1+. Eliminates the condensation of moisture on lenses that causes fogging so your lenses and vision stay clear.

- 250-01-0000 Black temple, clear lens, anti-scratch - \$17.69
- 250-01-0001 Black temple, gray lens, anti-scratch - \$17.69
- 250-01-0002 Black temple, I/O lens, anti-scratch - \$17.69
- 250-01-0005 Black temple, silver mirror lens, anti-scratch - \$17.69
- 250-01-0020 Black temple, clear lens, anti-scratch, anti-fog - \$17.69
- 250-01-0021 Black temple, grey lens, anti-scratch, anti-fog - \$17.69
- 250-01-0900 Clear temple, clear lens, anti-scratch - \$17.69
- 250-01-0902 Clear temple, I/O lens, anti-scratch - \$17.69
- 250-01-0920 Clear temple, clear lens, anti-scratch, anti-fog - \$17.69

250-01-0001



250-01-0005



250-01-0021



250-01-0902



250-01-0002



250-01-0020



250-01-0900



250-01-0920



BOUTON BLIZZARD

Offered in a stylish white half frame and featuring a secure, comfortable fit. Lightweight, semi-rimless design offers all day comfort. Bayonet temples are rubber co-molded for a comfortable fit. Non-slip rubber nose pads provide a secure fit. 8 Base curve lens. Meets ANSI Z87.1+ and CSA Z94.3. Treated front and back with a clear, scratch-resistant coating for a much harder surface that is more resistant to scratching. Eliminates the condensation of moisture on lenses that causes fogging so your lenses and vision stay clear.

- 250-48-0006 White frame, blue mirror lens - \$6.49
- 250-48-0021 White frame, gray lens - \$6.49
- 250-48-0226 White frame, I/O blue lens - \$7.49

250-48-0006



250-48-0021



250-48-0226



BOUTON CAPTAIN

Black frame, gray lens, anti-fog/anti-scratch, 9 base curve, bayonet temples with end tips that curve out for ease of placement on face, ANSI compliant.

250-46-0021 - \$4.49



BOLLE SAFETY RUSH

High impact 2.2 mm smoke polycarbonate lens, anti-fog/anti-scratch, 10 base curve, 99.99% UVA/UVB light absorption, ANSI compliant.

40071 - \$7.99



BOLLE SAFETY SLAM

High impact 2.3 mm polycarbonate lens, anti-fog/anti-scratch, 11 base curve, 99.99% UVA/UVB light absorption, ANSI compliant.

40081 - \$7.99



BOLLE SAFETY CONTOUR METAL

High impact 2.2 mm polycarbonate lens, anti-fog/anti-scratch, 8 base curve, 99.99% UVA/UVB light absorption, ANSI compliant.

40050 - \$18.99



BOLLE SAFETY SHADOW

High impact 2.0 mm red mirror polycarbonate lens, anti-scratch, 8 base curve, 99.99% UVA/UVB light absorption, ANSI compliant.

40159 - \$17.99



SKULLERZ THOR

Rubber co-injection temples for a secure fit, polycarbonate lenses with scratch-resistant coating filter 99.9% of harmful UVA, ANSI compliant, MIL-PRF-32432 compliant.

51330 - \$18.99





HEXARMOR CHROME SERIES GLOVES

Superior back-of-hand impact protection system utilizes an advanced design to dissipate forceful blows over a large area. Durable TP-X palm for exceptional grip. Elastic cuff with velcro closure. Washable. Available in sizes S-3XL.

4027 - \$41.99



HEXARMOR CHROME SERIES LEATHER GLOVES

SuperFabric brand material on palm interior provides cut protection for some of the highest cut-resistance available. Goatskin leather palm provides a traditional style of comfort and grip. Available in sizes S-2XL.

4081 - \$41.99



NEW

HEXARMOR CHROME OASIS GLOVES

Advanced HexVent technology allows for a breathable heat-release system. Printed PVC synthetic leather palm for exceptional grip. Superior back-of-hand impact protection system design to dissipate forceful blows over a large area. Available in sizes S-3XL.

4030 - \$40.49

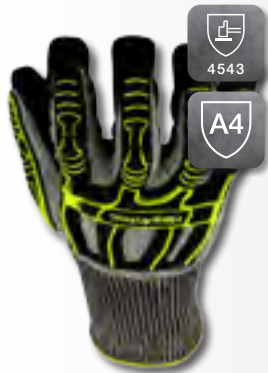

HEXARMOR RIG LIZARD THIN LIZZIE GLOVES

13-gauge high-performance polyethylene and glass fiber blend shell protects hands from cut hazards while allowing maximum dexterity. IR-X Impact Exoskeleton design for protection to back of hand and sandy nitrile palm for exceptional grip. Washable. Available in sizes S-2XL.

2090 - \$25.99



HEXARMOR RIG LIZARD GLOVES

Synthetic palm with unique stitching pattern offers unrivaled comfort and dexterity. IR-X Impact Exoskeleton protects against forceful blows to the back-of-hand. Additional IR-X guard between thumb and index finger. Exterior seams implement a double stitched core-spun thread. SlipFit cuff adds comfort and convenience. Hi-vis color scheme increases visual awareness. Launderable. Available in sizes XS-3XL.

2021 - \$34.99



HEXARMOR RIG LIZARD ARCTIC GLOVES

Dynamic combination of H2X and Thinsulate interior liners for waterproof and cold-resistance. Synthetic palm with unique stitching pattern offers unrivaled comfort and dexterity. IR-X Impact Exoskeleton protects against forceful blows to the back-of-hand. Additional IR-X guard between thumb and index finger. SlipFit cuff adds comfort and convenience. Hi-vis color scheme increases visual awareness. Machine washable. Available in sizes S-3XL.

2023 - \$43.49



HEXARMOR RIG LIZARD ARCTIC GLOVES LEATHER PALMS

Thinsulate interior liner keeps hands warm. Waterproof barrier. Genuine goatskin leather palm with unique stitching pattern provide industry-leading cut and abrasion resistance. IR-X Impact Exoskeleton protects against forceful blows to the back-of-hand. Additional IR-X guard between thumb and index finger. SlipFit cuff with Velcro closure. Hi-vis color scheme increases visual awareness XT. Available in sizes S-3XL.

2033 - \$53.99





ERGODYNE PROFLEX 710CR CUT RESISTANCE GLOVES

Armortex-backed palm for enhanced cut protection. Padded palm with Tena-Grip reinforcement. Technical hex-stretch knit construction. Low-profile molded hook and loop closure. Pull-on tab for easy on / off.

- 17122 S - \$41.95
- 17123 M - \$41.95
- 17124 L - \$41.95
- 17125 XL - \$41.95
- 17126 2XL - \$41.95



ERGODYNE PROFLEX 812CR UTILITY CUT RESISTANCE GLOVES

Armortex-backed palm for enhanced cut protection. Reinforced thumb saddle wear area. Breathable poly mesh construction. Low-profile molded hook and loop closure with ID space. Pull-on tab for easy on / off.

- 17182 S - \$32.99
- 17183 M - \$32.99
- 17184 L - \$32.99
- 17185 XL - \$32.99
- 17186 2XL - \$32.99



ERGODYNE PROFLEX 815 QUICKCUFF UTILITY GLOVES

Made from synthetic leather palm with a reinforced thumb saddle wear area. Features breathable poly mesh construction, quickcuff elastic gauntlet fit with ID space, and pull-on tab for easy on/off.

- 17202 S - \$17.99
- 17203 M - \$17.99
- 17204 L - \$17.99
- 17205 XL - \$17.99
- 17206 2XL - \$17.99



ERGODYNE PROFLEX 710LTR LEATHER REINFORCED GLOVES

Made from genuine leather-reinforced palm and fingertips for a natural feel. Features technical hex-stretch knit construction, neoprene knuckle pad, low-profile molded hook and loop closure with ID space, and pull-on tab for easy on / off.

- 17142 S - \$32.99
- 17143 M - \$32.99
- 17144 L - \$32.99
- 17145 XL - \$32.99
- 17146 2XL - \$32.99



ERGODYNE PROFLEX 720LTR LEATHER REINFORCED GLOVES

Framing finger configuration for grasping fasteners. Padded palm with durable leather reinforcement. Technical hex-stretch knit construction. Neoprene knuckle pad. Low-profile molded hook and loop closure with ID space. Pull-on tab for easy on / off.

- 17152 S - \$31.99
- 17153 M - \$31.99
- 17154 L - \$31.99
- 17155 XL - \$31.99
- 17156 2XL - \$31.99



ERGODYNE PROFLEX 924 HYBRID DORSAL IMPACT-REDUCING GLOVES

Full finger TPR and foam knuckle padding, padded palm with Tena-Grip reinforcement, hi-vis fingertips and reinforced thumb saddle, breathable mesh construction.

- 17682 S - \$34.99
- 17683 M - \$34.99
- 17684 L - \$34.99
- 17685 XL - \$34.99
- 17686 2XL - \$34.99



ERGODYNE PROFLEX 9015FX ANSI CERTIFIED ANTI-VIBRATION GLOVES

Certified anti-vibration protection. Full-length AVC palm padding reduces vibration and palm impact. Molded TPR armor on knuckles and fingers protects the back of hand. Hex stretch knit and breathable. Hook and loop closure.

- 17302 S - \$56.95
- 17303 M - \$56.95
- 17304 L - \$56.95
- 17305 XL - \$56.95
- 17306 2XL - \$56.95





MAXIMUM SAFETY JOURNEYMAN GLOVES

Brown goatskin leather reinforced palm and back. Hi-vis yellow knuckle protectors. Split goatskin leather reinforced fingertips. Internal foam padded palm. TPR molded knuckle guards. Nylon spandex fabric. Sandy PVC thumb crotch and thumb reinforcement. Easy on / off design. Hook and loop closure patch. Available in sizes S-2XL.

120-4200 - \$24.95



PMI ROPE TECHNICIAN GLOVES

Synthetic leather (palm base layer), cowhide layer (finger wear points and palm). Ergonomically shaped. Two-way stretch spandex on top and fingers. Available in sizes M-XL.

GL2230 - \$38.00



PMI FINGERLESS BELAY GLOVES

Constructed of pliable goatskin and an extra layer of durable cowhide across the palm. An original innovative designed leather pull tab between the fingers makes removal easy. Fingers covered just enough for protection and lightweight. Available in sizes M-XL.

GL2240 - \$35.50



TILLMAN TRUEFIT ULTRA GLOVES

Made from top grain gold / pearl goatskin and nylon spandex. Double reinforced finger tips. Clute cut design. Padding in palm for comfort. Elastic cuff for support and protection. Hook and loop top wrist closure for adjustability. Available in sizes S-2XL.

1490 - \$16.95



TILLMAN TRUEFIT 1470 GLOVES

Made with top grain goatskin, leather, and spandex; reinforced thumb. Elastic cuff with hook and loop closure for a secure fit. Top grain leather side bolsters. Available in sizes S-XL.

1470 - \$12.25



PETZL K52 CORDEX BELAY & RAPPEL GLOVES

Lightweight, made from natural, high-quality leather. Double layered in high-wear areas. Breathable nylon back, neoprene cuff with velcro closure. Available in sizes S-XL.

K52 - \$39.95



PETZL K53 CORDEX PLUS RIGGING & RAPPELLING GLOVES

Ergonomic cut for high dexterity without being too tight; made of high quality goat skin for perfect balance between durability and dexterity; goat skin leather; carabiner hole to attach gloves to harness. Available in tan and black. Available in sizes S-XL.

K53 - \$49.95



PMI LIGHTWEIGHT RAPPEL GLOVES

Lightweight, pliable goatskin provides excellent finger dexterity while two extra layers of cowhide across the palm maximize protection where you need it most. Available in sizes S-2XL.

GL2200 - \$38.00





MAXIFLEX CUT GLOVES

High performance yarns and fibres offer cut protection while maintaining high levels of comfort. Reinforcement between the thumb and forefinger improves cut resistance and extends glove life in an inherently weak area. Micro-foam nitrile coating offers 360° breathability, mimics the "hand at rest", reducing hand fatigue and increasing comfort. Optimized grip delivered through our micro-cup finish, allows for a controlled grip. Available in sizes S-2XL.

34-8743 - \$6.49



GEAR EXPERTS®

“ The biggest complaint that workers have about gloves is that they're bulky and cumbersome. The biggest complaint that safety officers have about gloves is that they can't get their people to wear them. The Maxiflex Cut is a great glove for applications requiring mid-range cut protection without sacrificing too much dexterity. Remember - if your employee has to take their glove off to do their job, it's the wrong glove. ”



BRYAN DOMINIQUE
Northeastern Regional Sales Manager

MAXIFLEX ULTIMATE AD-APT COOLING GLOVES

Microfoam nitrile coatings are compatible with light oils and will provide a good grip and excellent abrasion resistance. AD-APT technology releases micro-encapsulated, natural cooling agents to keep hands drier, fresh and clean. 360° breathability, and ultra thin. Micro-cup finish allows for a controlled grip. The Skin Health Alliance has awarded professional dermatological accreditation following review of the scientific dossier behind this product. Available in sizes S-2XL.

42-874 - \$3.99



GREAT WHITE 3GX GLOVES

Dyneema Diamond and Lycra shell is lightweight and provides excellent dexterity, tactile sensitivity and cut resistance. Polyurethane coated palm and fingertips. Outstanding wet/dry grip. Available in sizes XS-2XL.

19-D322 - \$7.99

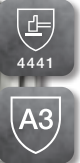

MAXICUT ULTRA GLOVES

Seamless knit engineered yarn glove with premium nitrile coated microfoam grip on palm & fingers. Designed and developed as a 360° breathable cut resistant glove. MaxiCut Ultra combines high levels of cut protection with comfort, flexibility and dexterity for dry environments. The Skin Health Alliance has awarded professional dermatological accreditation following review of the scientific dossier behind this product. Available in sizes S-3XL.

44-3745 - \$11.99



G-TEK POLYKOR KRYSTAL GLOVES

PolyKor Krystal combines hardened crystallized minerals with the woven fabric for durability and cut resistance. Coating palm and finger tips for great abrasion resistance. Outstanding wet/dry grip. Available in sizes XS-2XL.

16-X540 - \$5.25

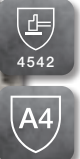

G-TEK KEVLAR GLOVES

Kevlar and Lycra blend. 15-gauge and lightweight. Polyurethane coat. Kevlar will not melt, ignite or conduct electricity. Dupont Kevlar fiber provides high tensile strength relative to its weight - up to five times stronger than steel. Available in sizes S-2XL.

09-K1250 - \$3.99

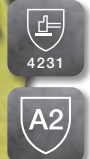
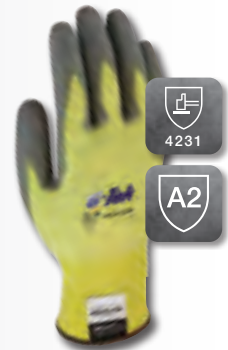

HEXARMOR 2000 SERIES GLOVES

Shell is comprised of a 13-gauge high-performance polyethylene fiber and glass fiber blend. Gray polyurethane palm dip. Washable. Available in sizes S-2XL.

2085 - \$12.99



PERSONAL SAFETY // HAND PROTECTION



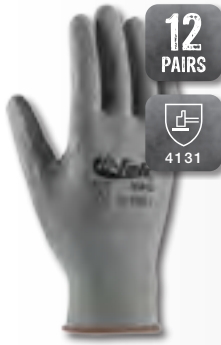

12 PAIRS
4131

G-TEK NYLON GLOVES WITH POLY GRIP

Seamless knit nylon shell offers increased comfort, finger dexterity and breathability. Polyurethane (PU) coatings offer great puncture and abrasion resistance while offering excellent tactile sensitivity. Breathable back for comfort. Available in sizes S-2XL.

33-G125 S - \$18.00



12 PAIRS
4131

MAXIFLEX ENDURANCE GLOVES

Black micro-foam nitrile, fully coated including ribbed knit wrist, 15-gauge Nylon/Lycra liner. SinAqua repels water and light oil. Actifresh impedes odors and eliminates germs. Designed to produce minimal lint and dust, excellent dexterity, sensitivity and tactility. Available in sizes S-2XL.

34-8745 - \$55.50



2243

G-TEK GP GLOVES

Latex crinkle grip coating palm and fingertips provides superior grip in wet and dry conditions. Knit wrist helps prevent dirt and debris from entering the glove. Seamless cotton/polyester knit shell is comfortable and flexible. Available in sizes S-2XL.

39-1310 - \$15.15



VIDEO
12 PAIRS
4121

MAXIFLEX ELITE GLOVES

Blue micro-foam nitrile coated palm and fingertips. Micro-foam nitrile coating offers 360° breathability. Ultra lightweight liner creates smooth and rounded fingertips. Silicone free. Available in sizes S-2XL.

34-274 - \$39.99



4343
A4

G-TEK POLYKOR GLOVES

High performance polyethylene fiber shell is lightweight and provides excellent dexterity. Polyurethane coated palm and fingertips. Outstanding wet/dry grip. Resistant to chemicals, water, and ultraviolet light. Washable. Available in sizes S-2XL.

16-530 - \$5.75



QUICK SHIP VIDEO 12 PAIRS 4131

MAXIFLEX ULTIMATE GLOVES

Black micro-foam nitrile coated palm and fingertips. 15-gauge gray seamless knit nylon with Lycra liner, breathable coating keeps hands cool and dry. Designed to produce minimal lint and dust. Minimal penetration. Silicone free. Excellent dexterity, sensitivity and tactility. Used in applications which require a high degree of dexterity and sensitivity. Available in sizes XS-2XL.

34-874 - \$39.99

GEAR EXPERTS®

“These are your go to if you're looking for a hand protection solution for every day work. This is a high dexterity glove that offers high abrasion resistance and great tear resistance. If you're looking for cut or puncture protection this isn't the glove for you, you'll find our cut gloves one page over. Our most popular glove for a reason, the Maxiflex Ultimate will protect you from day to day hazards at a fraction of the cost of a cut rated glove.”



MICHAEL OBUCHOWSKI
Southwestern Regional Sales Manager



VIDEO 12 PAIRS 4121

MAXIDRY BY ATG GLOVES 3/4 DIPPED

Ultra lightweight nitrile on fine gauge seamless knit nylon liner, 3/4 dipped coating, EN certified 100% low level chemical and oil repellent. Maximum finger tip tactile sensitivity. GripTech coating offers non-slip capabilities, locking cuff, LiquiTech Barrier Technology provides resistance to oils and liquids, silicone free. Available in sizes S-2XL.

56-425 - \$58.99

56-424 Dipped coating on palm and fingertips only - \$54.29



RESPIRATOR 101

When working in hazardous environments or with hazardous materials, taking every precaution to protect your lungs is essential. Respirators are designed to filter out specific particles, chemicals, or vapors, to prevent them from causing injury, illness, or worse.

WHAT ARE THE HAZARDS?

Determining hazards present in a particular job is the first step to selecting a respirator. Each type of respirator has features designed to mitigate the risk associated with various airborne irritants.

SOME COMMON HAZARDS ARE:

- Particulates - silica, hazardous dust and fibers
- Welfume - stainless and galvanized steel
- Lead
- Asbestos/Mold
- Bleach/Ammonia - General cleaning products
- Pesticides/Insecticides
- Solvents - Water based latex
- Chemicals - Sulfur dioxide, chlorine, ammonia

While this is not a complete guide for every hazard you might encounter, it cannot be stressed enough the importance of matching the respirator and filter with the hazards present.

ASSESS THE SITUATION

Next, the jobsite should be assessed for overall employee exposure. Do all workers on the site need respiratory protection or just those in the immediate area of the hazard?

Air quality is typically measured in parts per million (ppm) or milligrams per cubic meter of air (mg/m3). Specific guidelines are outlined in OSHA's Respiratory Protection Standard 29 CFR 1910.134.

LEVEL OF PROTECTION

Depending on the type of hazard, and level of exposure, you may need a specific style of respirator.

THERE ARE THREE MAIN TYPES:

Disposable, Half Mask, and Full Face.

Disposable respirators are the most basic form and provide short-term protection. They may not be suitable for all types of hazards.

Half mask and full face respirators are usually reusable and provide more protection. They also add the convenience of having replaceable filters to swap out for different protection needs.

For even more hazardous environments, there are also supplied air systems which completely supplement the air in the work environment for clean, safe air.

FILTERS

The filter of the respirator allows air to flow through, but blocks the hazards. Disposable respirators come with a built in filter, where half and full face respirators have removable filters which can be changed based on the hazard, or replaced when they become worn out.



FILTERS CAN HAVE 1 OF 3 LETTER CLASS RATINGS:

- Class N - Not oil resistant
- Class R - Resistant to oil
- Class P - Oil proof

They also use a 3 number rating system, based on how well they filter particles measuring 0.3 microns or larger in diameter.

- 95 - Filters 95% of all particles
- 99 - Filters 99% of all particles
- 100 - Filters 100% of all particles.

These two filter classes are typically noted in this form: N95, P100, etc.

FIT

When wearing a respirator, it is essential that it fit correctly. A user should be fit to ensure that they have selected the proper size and style of respirator. This test should be administered by a trained person, and repeated regularly.

A seal check should be performed each time the respirator is donned, to check for gaps that allow air to pass between the face and the face seal.

STANDARDS

OSHA only allows respirators approved by the National Institute for Occupational Safety and Health (NIOSH) for workplace use.

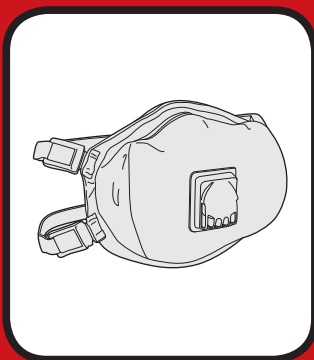

DISPOSABLE

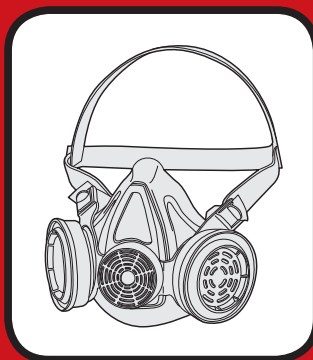

HALF MASK



3M N100 DISPOSABLE RESPIRATOR

NIOSH's highest rated filtration efficiency in a disposable respirator N100, CoolFlow valve helps keep wearer cool, comfortable foam face seal, adjustable buckle straps, compatible with a variety of protective eye wear and hearing protection, adjustable nose clip, individually packaged.

8223 N100 - \$9.99
8293 P100 - \$10.99



QUICK SHIP

ONE-FIT RESPIRATOR

Designed to be an economical choice for effective single-use respiratory protection. 95% filtration efficiency against solid particulates and non-petroleum based liquid aerosols. Meets NIOSH standards for N95 protection and CDC guidelines for M. tuberculosis exposure control. Recommended for protection against many substances including pandemic diseases.

14110445 - \$7.99



3M HALF FACE PIECE 6000 SERIES REUSABLE RESPIRATOR

Offers reliable, convenient respiratory protection when combined with 3M Particulate Filters or Cartridges, compatible and convenient respiratory protection. Available in sizes S-L.

6300 - \$14.99



3M FULL FACE 6000 SERIES RESPIRATOR

Quick and easy cleaning; large lens for wide field of view; silicone faceseal for enhanced comfort and durability; air purifying respirator (APR), supplied air (SA) and powered air purifying respirator (PAPR) modes, helps provide respiratory protection against a wide variety of gases and vapors when used with approved cartridges and filters. Available in sizes S-L.

6900 - \$144.99



BOX OF 10

N95 CONE RESPIRATOR

95% filtration efficiency against airborne particles, low breathing resistance and a soft inner lining ensure all-day comfort, adjustable outside nosepiece (with inside foam padding), flanged mask edge for better face seal, head straps, (10) masks.

270-2050 With valve (10) masks - \$8.49

270-2000 Without valve, (20) masks - \$9.69

8214 Disposable - \$32.99

8577 P95 Disposable - \$42.99



NORTH 4200 SERIES HALF MASK

Elastomeric half masks with a single particulate filter. Using a cradle suspension the mask offers the comfort of a half-mask with the cost of a disposable respirator. Ideal for dusty environments that require frequent change out of filters. Available in sizes S-L.

4200 Standard - \$13.75

4200W Welding - \$27.25

3M RESPIRATOR FILTERS

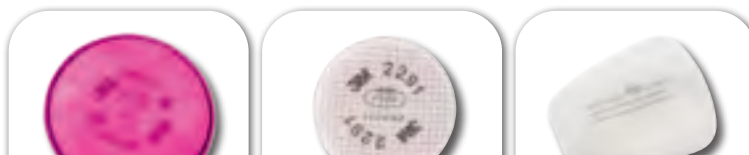

PART	FILTER TYPE	NIOSH APPROVED FOR	COMPATIBLE WITH	QTY	PRICE
2091	P100	Particulates	6000, 6500, 7500, & FF-400 Series	2	\$6.99
2291	P100	Particulates	6000, 6500, 7500, & FF-400 Series	2	\$7.99
2096	P100 with nuisance level Acid Gas	Particulates	6000, 6500, 7500, & FF-400 Series	2	\$8.99
2296	P100 with nuisance level Acid Gas	Particulates	6000, 6500, 7500, & FF-400 Series	2	\$9.99
2097	P100 with nuisance level Organic Vapor	Particulates	6000, 6500, 7500, & FF-400 Series	2	\$8.99
2297	P100 with nuisance level Organic Vapor	Particulates	6000, 6500, 7500, & FF-400 Series	2	\$9.99
5N11	Prefilter for N95	Non-Oil Particulates	6000, 6500, 7500, & FF-400 Series	10	\$14.99
5P71	Prefilter for P95	Particulates	6000, 6500, 7500, & FF-400 Series	10	\$17.99

3M RESPIRATOR CARTRIDGES

PART	CARTRIDGE TYPE	NIOSH APPROVED FOR	COMPATIBLE WITH	QTY	PRICE
60923	OV/AG/P100/Organic Vapor/Acid Gas/ P100	Certain Organic Vapors, Chlorine, Hydrogen Chloride, and Sulfur Dioxide or Hydrogen Sulfide or Hydrogen Fluoride & Particulates	6000, 6500, 7500, & FF-400 Series	2	\$21.99
60924	AM/MA/P100/Ammonia/Methylamine/P100	Ammonia and Methylamine & Particulates	6000, 6500, 7500, & FF-400 Series	2	\$24.99
60925	FM/OV/P100/Formaldehyde/Organic Vapor/P100	Formaldehyde and Certain Organic Vapors & Particulates	6000, 6500, 7500, & FF-400 Series	2	\$24.99
60926	MG/ V/P100/ Multi-Gas/Vapor/P100	Certain Organic Vapors, Chlorine, Hydrogen Chloride, Chlorine Dioxide, Sulfur Dioxide, Hydrogen Sulfide, Ammonia/Methylamine, Formaldehyde or Hydrogen Fluoride & Particulates	6000, 6500, 7500, & FF-400 Series	2	\$23.99
60926S	HG/P100/Mercury/P100	Mercury Vapor, Chlorine, Sulfur Dioxide & Certain Particulates	6000, 6500, 7500, & FF-400 Series	2	\$32.99





PAC-KIT EMS TRAUMA KIT

11.5" x 10.5" x 5" case dimensions. (151) pieces. Emergency response trauma kit includes a full assortment of EMS grade first responder supplies. Snap cover closure soft bag with organizer compartments inside. Roomy but compact. Aluminized thermal blanket, cold packs, EMT shears, gauze bandages, elastic bandages, gauze pads, hema-seal trauma dressing, gloves, wound pads, burn gel, multi-trauma dressing, adhesive tape, alcohol wipes, iodine wipes, eye and skin wash, eye pads, biohazard bag, first aid guide, CPR masks, and forceps.

3500 - \$132.99



PAC-KIT GME SUPPLY EMS BAG

Emergency kit includes adhesive bandages, emergency blanket, bottle of purified water, bloodborne pathogens and CPR mask, CPR mask with one way valve, body fluid spill clean up pack, small wound dressing pack, topical powder, stretch gauze bandage wrap, gauze pads, instant cold packs, sterile multi trauma dressings, scissors, gloves, burn gel, ammonia inhalants, tape, eye pads, alcohol cleansing pads, triangular bandage, triple antibiotic, pupil gauge, first aid booklet, all in a nylon case with carrying handles.

GMEEMS - \$110.00



PAC-KIT TITANIUM BONDED SHEARS

These 7" shears are perfect for ER and EMS staff, or for use in rescue kits. Titanium bonded blades are able to cut through lanyards or harness webbing in the event of a rescue situation.

90292 - \$7.95



PAC-KIT EMERGENCY CPR KIT

7.5" x 7" x 2" case dimensions. (11) pieces. Emergency CPR kit includes mask, gloves, antiseptic wipes, emergency blanket and biohazard bag, zip up soft pouch with handles.

3020 Soft pouch - \$21.99

3025 Hard case - \$17.99



PAC-KIT FIRST RESPONDER KIT

17.5" x 12" x 13.5" case dimensions. (98) pieces. Durable Flambeau portable case, includes abdominal pads, fabric adhesive strips, assorted bandages, cloth adhesive tape, aluminized rescue blanket, antiseptic wipes, biohazard bags, cold packs, assorted gloves, sterile eye cup, eye wash, eye pads, forceps, trauma dressings, scissors, triple antibiotic ointment packets, water gel burn dressing.

3100 - \$121.99



PAC-KIT ALL-TERRAIN FIRST AID KIT

For intense working conditions. Contains essential supplies for common injuries on fracking, mining, oil/gas refinery, and power generation/utilities work sites. Comes stocked with emergency supplies to combat severe burns, eye injuries, major wounds, snake bites, stings, and other on-site emergencies.

9000 - \$199.99



NORTH MAJOR TRAUMA KIT

Kit includes adhesive tape, assorted bandages, hand wash, bloodstopper, facial dressing, eye wash, emergency blanket, rescue blanket, forceps, scissors, cold packs, first aid booklet, ABD pads, gauze pads, eye pads, Microshield CPR Mask, splint boards, gloves, wipes, hydrocortisone, all in a rugged nylon bag with carrying straps for easy transport.

148820 - \$220.99



PAC-KIT EMERGENCY RESPONSE BACKPACK

12" x 16" x 5" case dimensions. (91) pieces. Emergency response backpack includes a full assortment of EMT grade first responder supplies. Soft sided zip up backpack with carrying straps.

3300 - \$139.99





FIRST AID ONLY CLASS B FIRST AID KIT

Class B. 17" x 26" x 5.75" case dimensions. The industrial sized First Aid Only cabinet combines Smart Compliance with our most popular bulk items. This cabinet is organized for reordering ease. Higher piece counts on items, more variety to meet your needs, and color coded packaging helps you find items faster. Solid steel case comes with a carrying handle and is wall mountable.

90832 (200) Person kit - \$399.99



PAC-KIT PHYSICIANS CARE FIRST AID KIT & EYE WASH STATION

Combination eyewash and first aid station. First aid kit provides essential supplies for most common workplace injuries. 16 oz eyewash for flushing or irrigating the eyes. Includes eye cup for easily focusing the fluid stream into affected eye, wall mountable, includes mounting hardware. ANSI and OSHA compliant. FDA approved eyewash.

24-500 (25) Person kit - \$43.99



PAC-KIT EYE WASH REFILL

Replacement bottles of sterile isotonic buffered solution for flushing or irrigating the eyes.

24-101 16 oz bottles - \$8.99

24-201 32 oz bottles - \$13.99



PAC-KIT 3 SHELF STEEL FIRST AID STATION

17.5" x 13.5" x 6" case dimensions. (50) 1" x 3" heavy woven fabric strips; (10) heavy woven extra large strips; (25) heavy woven knuckle bandages; (25) heavy woven fingertip bandages; 12" sterile gauze bandages; 14" sterile gauze bandages; (10) 2" gauze pads; (10) 3" gauze pads; (10) 4" gauze pads; hema-seal trauma dressing; 22" tri-cut adhesive tape; (2) triangular bandages; (100) alcohol antiseptic wipes; (25) antiseptic towelettes; (25) first aid/burn cream packets; (25) triple antibiotic ointment packets; 14 oz eyewash, sterile eye cup, pads, strips; 14 oz burn spray; 14 oz antiseptic spray; (50) extra strength non-aspirin tablets; (100) cotton tip applicators; large instant cold pack; 14" elastic bandages; (100) exam gloves; scissors; forceps; and first aid guide.

6155 (100) Person kit - \$158.99

6155R (100) Person kit refill - \$79.99



FIRST AID ONLY CLASS A+ BULK FIRST AID KIT

Class A+, Type 1 & 2. 13.25" x 14.25" x 4 case dimensions. Innovative plastic case comes with a carrying handle and is wall mountable.

90608 (50) Person kit - \$134.99



PAC-KIT EYE WASH STATION

Twin bottle eye flush station with wall mount. Used for flushing or irrigating the eyes. Includes eye cup for easily focusing the fluid stream into affected eye.

24-102 (2) 16 oz bottles of eye wash - \$21.99

24-300 (2) 32 oz bottles of eye wash - \$39.99

24-202 Single station with (1) 32 oz bottle of eye wash - \$19.99





PIP FIRST AID KIT

Contains the supplies you need to treat minor injuries. Plastic box is gasketed for weatherproof protection. Convenient molded carry handle includes slots for wall mounting. Lightweight kit is ideal for use in the office or vehicle. Labels have first aid instructions in English and Spanish. Meets ANSI Z308.1-2009 requirements.

- 299-13210 (10) Person kit - \$13.99
- 299-13225 (25) Person kit - \$18.99
- 299-13255 (50) Person kit - \$34.99



FIRST AID ONLY CLASS A+ BULK FIRST AID KIT

Class A+, Type 3. 9.5" x 10" x 3" case dimensions. (183) pieces. Weather resistant plastic case includes carrying handle and slots for wall mounting. Lightweight kit is ideal for use in the office or vehicle. Meets ANSI/ISEA Z308.1-2015 requirements.

- 90565 (50) Person kit - \$49.99
- 90617 (50) Person refill - \$39.95



FIRST AID ONLY CLASS A BULK FIRST AID KIT

Class A, Type 3. 9.5" x 6.5" x 3". (89) pieces. Plastic case includes a gasket and is weather-resistant. The contents can be refilled. This Class A standard kit contains basic fill contents that are designed for the most common types of workplace injuries. ANSI / ISEA Z308.1-2015 compliant.

- 90562 (25) Person kit - \$28.99
- 90583 (25) Person refill - \$25.30



PAC-KIT WEATHERPROOF PLASTIC FIRST AID KIT

Weatherproof plastic. Gasket seal keeps contents free of dust and moisture. Neat, orderly interior packaging makes contents easy to locate and use. OSHA compliant box has easy carry handle or is wall mountable. Contents meet or exceed those required items from ANSI Z308.1-2009.

- 6410 (10) Person kit - \$16.99
- 6430 (25) Person kit - \$20.99
- 6490 (50) Person kit - \$29.99



FIRST AID ONLY CLASS B BULK FIRST AID KIT

Class B, Type 3. 9.5" x 10" x 3" case dimensions. (199) pieces. Weather resistant plastic case kit includes carrying handle and slots for wall mounting. Lightweight kit is ideal for use in the office or vehicle. Meets ANSI/ISEA Z308.1-2015 requirements.

- 90566 (50) Person kit - \$79.95
- 90586 (50) Person refill - \$69.95



PAC-KIT WEATHERPROOF VEHICLE FIRST AID KIT

4.5" x 7.5" x 2.75" case dimensions. Weatherproof steel. Contents meet or exceed those required items from ANSI Z308.1-2009. OSHA compliant box has easy carry handle or is wall mountable.

- 6400 (10) Person kit - \$31.49
- 6420 (25) Person kit - \$40.99
- 6450 (50) Person kit - \$49.99





ERGODYNE CHILL-ITS HI-VIS RANGER HAT WITH COOLING TOWEL

Wide brim and vented mesh side panels, lined with an advanced PVA material for the ultimate in cooling relief. Easily activated by running under water for one minute. Cooling sensation lasts for up to (4) hours. ANSI certified 150 D Oxford Polyester. Available in size S/M or L/XL.

12590 With Cooling Towel - \$14.99
23259 W/O Cooling Towel - \$12.99



ERGODYNE CHILL-ITS HIGH PERFORMANCE DEW RAG WITH POLYMERS

Hi Cool moisture management performance fabric transports moisture away. Comfortable to wear under hats, helmets or alone. Absorbent terry headband, elastic band for a great fit. Available in camo, stars & stripes, red western, navy western, lime, solid blue, Realtree Xtra Camo, black, flames and skulls.

12478 Camo - \$7.49



ERGODYNE CHILL-ITS COOLING TRIANGLE HAT WITH COOLING TOWEL

Advanced PVA material activates easily and quickly when run under water for one minute. Re-usable: just soak to re-activate, tie closure. Available in solid blue, stars & stripes, red western, navy western, lime, camo and flames.

12587 Solid Blue - \$8.99



ERGODYNE CHILL-ITS EVAPORATIVE COOLING BANDANA WITH COOLING TOWEL

Advanced PVA material activates easily and quickly when run under water for one minute. Re-usable: just soak to re-activate. Tie closure. Also available in stars & stripes, red western, navy western, lime, solid blue, camo and flames.

12561 Stars & Stripes - \$3.99



ERGODYNE CHILL-ITS EVAPORATIVE FR COOLING BANDANA

Activated polymers bring cooling power where you need it most. Activate by soaking in water for 2-5 minutes. Re-usable: just soak in water to re-activate. Tie closure. Available in lime and solid blue.

12601 Lime - \$6.99
12607 Solid Blue - \$6.99



ERGODYNE CHILL-ITS EVAPORATIVE COOLING TOWEL

Dampen this synthetic space age towel to create a cooling aid significantly colder than ambient air, advanced PVA material holds water without feeling heavy, super-evaporative, wear for hours or wipe off for quick relief, simply re-wet the towel to reactivate, machine washable, comes with reusable container for storage. Available in lime, orange, gray, blue and pink.

12439 Lime - \$9.99
12669 Lime Microfiber - \$9.99
12410 50 pack - \$249.99



ERGODYNE CHILL-ITS EVAPORATIVE COOLING BAND

Dampen this synthetic space age towel to create a cooling aid significantly colder than ambient air, advanced PVA cooling technology, super-evaporative, activates fast and easy - run under cold water for one minute, 1/3 the size of the Chill-Its 6602 with the same cooling power, use as a neck wrap by pulling end of wrap through slit, wear for hours or for quick relief, simply re-wet to reactivate, machine washable.

12418 - \$4.99





SQWINCHER SQUEEZE POPS - ASSORTED FLAVORS

Sqwincher Squeeze Pops go beyond the call for your traditional electrolyte replenishment. These freezer pops also offer a single-serve application with on-the-go results. Sqwincher is more satisfying than water or soft drinks because the body absorbs it more quickly and restores it to its proper electrolyte and fluid balance. Freeze and eat - frozen electrolyte replenishment. Quickly cools body temperature.

159200201 150 Pack - \$46.99



SQWINCHER ZERO SUGAR QWIK STIK HYDRATION DRINK MIX - 20 OZ.

Sqwincher helps keep your people safe on the job site. Sqwincher provides electrolytes that the body needs to recover from dehydration. The Qwik Sticks are easy to transport in a pocket or in a truck to keep on hand and hydrated. Available in lemon lime, fruit punch, grape, lemonade, mixed berry, orange, strawberry lemonade and watermelon. Cases available in lemon lime, fruit punch, lemonade and orange.

159060106 Lemon Lime (50 Pack) - \$161.53

690-060106-LL Lemon Lime (Case) - \$249.50

SQWINCHER 5 GALLON POWDER PACK

Sqwincher 5 Gallon Powder Packs help you make sure your crew stays properly hydrated. The sqwincher powder has been formulated to return all of the important minerals and fluids lost on the job-site.

016405-FP-1 Fruit Punch - \$8.49

016408-LL Lemon Lime (Case) - \$135.99



SQWINCHER ZERO QWIK STIK TUBES - ASSORTED FLAVORS

Great tasting, scientifically formulated electrolyte replacement drink is designed to restore important mineral salts and fluids lost through dehydration, physical exertion and heat stress.

060119SQ 20 Tubes - \$109.99



ERGODYNE CHILL-ITS WIDE MOUTH WATER BOTTLE

Portable water bottle to keep you hydrated while away from a water source, tough (BPA Free) impact resistant Tritan copolyester plastic, odor resistant with enhanced durability to high heat and humidity, wide mouth to easily fit ice cubes, dishwasher safe. Available in orange, gray, or lime.

13151 Orange - \$10.99

13152 Gray - \$10.99

13153 Lime - \$10.99



ERGODYNE CHILL-ITS NECK SHADE WITH COOLING TOWEL

Hook and loop allows for easy attachment. Quilted nylon outer layer, polymer-embedded fabric inside. Water-repellent liner. 100% nylon. Soak in water 2-5 minutes to activate, remains hydrated for up to 4 hours.

12523 - \$14.99



ERGODYNE CHILL-ITS EVAPORATIVE COOLING HARD HAT PAD WITH POLYMERS

Lightweight. Features cooling acrylic polymers. Hook and loop closures. Soak in water 2-5 minutes to activate, remains hydrated for up to (4) hours.

12337 Hat pad - \$2.99

12338 Liner - \$4.99

12336 Hat pad with neck shade - \$4.99



ERGODYNE CHILL-ITS EVAPORATIVE COOLING HARD HAT PAD WITH COOLING TOWEL

Advanced PVA material activates easily and quickly when run under water for one minute. Hook and loop closures. Reusable, just resoak.

12597 Hat pad - \$5.99

12596 Hat pad with neck shade - \$9.99



ERGODYNE CHILL-ITS TERRY SWEATBAND

Absorbent terry headband, fits most hard hat suspension systems. Machine washable. 100% cotton. Economical way for hard hat wearers to manage moisture.

12440 - \$5.99





**PIP CLEAR
FLAT CAP GEL
KNEE PADS**

Air-injected gel pads are ideal for work on hard surfaces, clear PVC cap features slip-resistant ridges to prevent sliding, flat kneeling surface prevents rocking to minimize fatigue, adjustable hook & loop closure strap.

291-130 - \$10.99



**PIP HARD
PLASTIC CAP
KNEE PADS**

Durable lightweight comfortable pads, abrasion resistant plastic knee cap, thick foam center padding, adjustable hook & loop closure straps.

291-100 - \$4.99



**PROFLEX
300 ROUNDED
CAP KNEE
PADS**

Rounded hard cap, best for swiveling and pivoting; Abrasion-resistant; 840 D nylon fabric cover; 12 mm NBR foam padding cut to hug the knee; Nickel-plated grommets; Buckle closure.

18300 - \$19.99



**PROFLEX
335HL SLIP
RESISTANT
RUBBER CAP
KNEE PADS**

Slip-resistant long rubber cap to grip wet or dry work surfaces; Hook and loop closure; 840 D nylon fabric cover; 12 mm NBR foam padding cut to hug the knee; Nickel-plated grommets.

18336 - \$26.55



**PROFLEX
350 GEL FOAM
KNEE PADS**

12 mm NBR gel padding and 20 mm EVA padding, hook and loop closure, gel comfort with slip resistant, puncture resistant soft cap.

18350 - \$38.99



**PROFLEX 342
EXTRA LONG
CAP INJECTED
GEL KNEE PADS**

Patented suspension design redirects pressure away from the patella, 100% injected gel and PU foam for long lasting comfort, wide/breathable lycra strap with hook and loop closure, unique fastening system uses calf muscle to eliminate straps behind knee, extended shin protection optimizes stability and comfort, adjusts to any calf size, silicone-free.

18442 - \$88.35



**PROFLEX
347 LONG
CAP GEL KNEE
PADS**

Lightweight gel cushioning and mobility; Full knee coverage and stability; Long cap design provides protection and stability; Non-slip rubber cap grips kneeling surface; Plastic clips cinch tight and keep straps secure.

18447 - \$49.99



**PROFLEX 367
ROUND CAP
GEL KNEE PADS**

Gel and EVA foam for lightweight comfort, grooved cap design for added grip, low profile cap prevents rollover, upper and lower elastic straps with hook and loop closure, short cap design for lightweight and mobile protection, silicone-free.

18467 - \$37.99



620 PROFLEX KNEE SLEEVE

Knee sleeve with Open Patella/Spiral Stays, contoured design conforms to the body's natural shape, neoprene four-way stretch fabric provides uniform support and warmth, ambidextrous.

16542 S (13-14") - \$22.99

16543 M (14-15") - \$22.99

16544 L (15-16") - \$22.99

16545 XL (16-18") - \$22.99

16546 2XL (18-20") - \$22.99



**PROFLEX
SINGLE STRAP
WRIST SUPPORT**

Limits downward (flexion) wrist movements, patented Open-Center Stay, elastic two-stage hook & loop closure, anti-odor treatment. Available in black or tan, sizes S-XL, left or right handed.

4000 - \$10.99





3M DISPOSABLE PROTECTIVE COVERALL WITH HOOD

Elastic waist, ankles, and wrists for convenience and freedom of movement. Two-way zipper with storm flap for convenience and to help provide additional protection. Anti-static coating on both sides helps reduce static build-up and prevent the risk of static discharge during use. Available in sizes M-4XL.

- 4510 With hood - \$6.99
- 4510CS Without hood - \$5.99

DUPONT TYVEK COVERALL

Comfort fit design, attached respirator-fit hood with elastic around face opening, designed to fit around respirator face mask; longer zipper extends to chin for complete coverage of neck area, elastic opening for tighter fit at wrist, attached skid-resistant boots.

- TY122S WH With boots - \$8.49
- TY127S WH Without boots - \$7.39

DUPONT TYCHEM 2000

A lightweight, and durable fabric with a polyethylene coating. Fabric provides at least 30 minutes of protection against 42 chemical challenges. Used for light splash protection in a variety of industrial environments. Attached hood with elastic around face opening. Elastic opening for tighter fit at wrist. Integrated socks composed. Available in sizes M-4XL.

- QC122B-M M - \$16.25
- QC122B-L L - \$16.25
- QC122B-XL XL - \$16.25
- QC122B-2XL 2XL - \$17.25
- QC122B-3XL 3XL - \$18.25
- QC122B-4XL 4XL - \$19.75



AMBI-DEX TURBO GLOVES

Industrial grade disposable nitrile glove. Powdered with textured grip. 5 mil.

- 63-332 - \$9.99
- 63-332PF Powder free - \$10.99



AMBI-DEX INDUSTRIAL GRADE DISPOSABLE LATEX GLOVE, 5 MIL

Fully textured, beaded cuff adds strength and prevents liquid run off. Ambidextrous and powdered. 21CFR, 170-199, ASTM A-3578.

- 62-322 - \$6.09
- 62-322PF Powder free - \$6.49



DUPONT TYVEK HOOD

Pullover hood design features elastic face opening for good fit around PAPR, extends over shoulders to provide full head protection, surged seams, one size fits most.

- TY657S WH - \$5.99
- Case pack (100) - \$89.99



3M DISPOSABLE PROTECTIVE OVERSHOE COVER

Offers a general barrier to non-hazardous substances, anti-static treated, universal size, elasticated ankle fitting. 150 pairs/case.

- 52562 - \$106.58



AMBI-DEX FOOD GRADE DISPOSABLE NON-LATEX GLOVE, 4 MIL

Look, fit, and feel of latex without concern of natural rubber; form-fitting textured grip, ambidextrous and powdered, 21CFR, 170-199.

- 64-346 - \$4.99
- 64-346PF Powder free - \$5.49



GO TO WWW.GMESUPPLY.COM/APPAREL
TO VIEW ENTIRE APPAREL SELECTION ONLINE



SIZING
CHART
ONLINE

**NATIONAL SAFETY
APPAREL FR
CLASSIC COTTON
HENLEY SHIRT**

Soft, breathable fabric; convenient left chest pocket; 3-button front placket; rib knit cuff and collar; generous sizing for optimal movement. NFPA and OSHA compliant. Available in sizes S-4XL in khaki, gray, navy, and orange.

C54PABSLS Khaki - \$68.99

C54PGBSLS Gray - \$68.99

C54PIBSLS Navy - \$68.99

C54PQBSLS Orange - \$68.99



**NATIONAL SAFETY
APPAREL FR
MODACRYLIC
SWEATSHIRT**

Inherently flame resistant; rib knit cuffs; reinforced front pockets; generous sizing for optimal movement; warmth without the weight; drawstring hood to fit over standard hard hat. NFPA and OSHA compliant. Available in sizes S-4XL.

C211G03 - \$107.99



**NATIONAL SAFETY
APPAREL EXPLORER FR
UNLINED BIB OVERALLS**

Durable water repellent finish; 26" covered FR zipper closure for easy entry; double bib pockets; (2) back pockets; (2) tool pockets on sides; quick disconnect adjustable buckles at each shoulder strap. NFPA and OSHA compliant. Available in waist sizes 30"40" and inseam sizes 30", 32", and 34".

BIB6DCM Caramel - \$119.99

BIB6DNV Navy - \$119.99



**NATIONAL SAFETY
APPAREL FR LEGACY
FIELD COAT**

Rugged outer shell with a soft, thin liner; heavy duty front zipper; larger hood to fit over standard hard hats; (2) lower front pockets; sporty styling; knit wrist cuffs. NFPA and OSHA compliant. Available in sizes S-3XL.

C55UPUKXLRG - \$152.99



**NATIONAL
SAFETY
APPAREL
DRIFIRE
PRIME**

Inherently flame resistant; lightweight breathable fabric for maximum comfort; athletic design and cut; odor control technology; uses dry-release moisture management technology. NFPA and OSHA compliant. Available in sizes S-3XL.

DF2-CM-762-PTP-RG Long Johns - \$74.99

DF2-CM-762-PBB-RG Boxer briefs - \$46.99

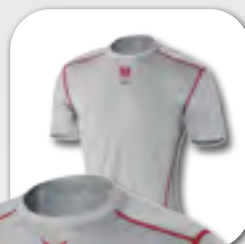

**NATIONAL
SAFETY
APPAREL
DRIFIRE
PRIME SHIRTS**

Inherently flame resistant; lightweight breathable fabric for maximum comfort; athletic design and cut; odor control technology; uses dry-release moisture management technology; tagless collar. NFPA and OSHA compliant. Available in sizes S-3XL.

DF2-CM-762-PLS-RG Long sleeve - \$72.99

DF2-CM-762-PTS-RG Short sleeve - \$53.99



TINGLEY CLASS 3 TYPE R ICON LTE JACKET

Polyurethane on 75 D ripstop polyester material. 2" silver reflective tape reflects light for 360° night time conspicuity. Lightweight, waterproof, mildew resistant, breathable material, while interchangeable liner options provide adaptability for all season comfort. Elastic cuffs with hook and loop take-up straps on sleeves. Roll-a-way adjustable hood in collar design, full-vented cape back, D-ring access, (4) pockets, exterior badge holder, 2 mic tabs. Available in sizes S-5XL.

J27122

S-XL - \$88.35

2XL-5XL - \$92.44



PIP CLASS 3 TYPE R FULL ZIP HOODED SWEATSHIRT WITH BLACK BOTTOM

Water 10 oz polyester fleece. Zipper closure water repellent shell treatment; 2" silver reflective tape; black bottom and cuffs to help hide dirt; front hand warmer pockets; left zippered chest pocket. Available in sizes M-5XL.

323-1370B Full zip - \$33.99

323-1350B Pullover - \$33.99

323-1330B 1/4 zip pullover - \$33.99



TINGLEY CLASS E ICON LTE PANTS

2" silver reflective tape reflects light for 360° night time conspicuity. Lightweight, waterproof, breathable material. Elastic waist pants with adjustable drawcord, hook and loop take-up straps on ankle cuffs, zippers at leg cuffs, and snap fly front. Available in sizes S-5XL.

PANTS P27122

S-XL - \$45.99

2XL-5XL - \$49.99

OVERALLS 024122

S-XL - \$58.99

2XL-5XL - \$62.99



PIP ANSI CLASS 3 TYPE R 2-PIECE VALUE RAINSUIT SET

Intended for workers requiring the highest level of visibility, lightweight polyester with waterproof PU coating and taped seams, 2" silver tape, zipper closure with storm flap, elastic waist pant with snap adjustable cuff, concealable hood for extra protection, ideal for rainy conditions in construction, municipalities, shipyards and anywhere hi-visibility is required and weather is a potential threat. Available in sizes S-5XL.

353-1000 - \$40.99



PIP CLASS 3 TYPE R RIPSTOP SOFTSHELL JACKET

Tri-laminate ripstop polyester softshell with fleece lining, removable fleece lined adjustable hood with zipper attachment, waterproof zipper closures, (4) outside pockets, (3) inside pockets, (2) mic tabs, drawstring waist adjustment. Available in sizes S-5XL.

333-1550 - \$69.99



NEESE AIR TEX

Waterproof, windproof, and breathable material. Polyester with polyurethane coating. Adjustable elastic suspenders. Available in sizes S-6XL.

9100APK Jacket, Class 3 - \$41.99

9100ET Trousers, Class E - \$22.99

9100BTF Bib trousers, Class E - \$34.99



SIZING
CHART
ONLINE



ANSI 107
R2



**PIP CLASS
2 TYPE R
4-POCKETS
VALUE MESH
VEST**

Breathable polyester mesh, 2" silver reflective tape, zipper closure, (2) lower internal pockets, (2) upper chest pockets including (4) pen pockets, ANSI compliant. Available in sizes M-5XL in hi-vis lime and hi-vis orange.

302-MVGZ4P - \$9.99

ANSI 107
R2



**PIP CLASS
2 TYPE R
2-TONE
10-POCKETS
SURVEYORS
VEST**

Breathable polyester mesh top and solid bottom, 2" two-tone reflective tape, (2) external flap pockets to fit tablets, (2) internal pockets, (2) pen pockets, (1) radio pocket, ID pocket. ANSI compliant. Available in sizes S-5XL in hi-vis lime and hi-vis orange.

302-0700 - \$14.10

ANSI 107
R2



**PIP CLASS
2 TYPE R
2-POCKETS
VALUE MESH
VEST**

Breathable polyester mesh, hook and loop closure, 2" silver reflective tape, (1) internal lower pocket, (1) external chest pocket. Available in sizes M-5XL in hi-vis lime and hi-vis orange.

302-0702 - \$5.99

**GLOWEAR
8020HL NON-
CERTIFIED
STANDARD
VEST**

Made from polyester mesh with hook and loop closure. Available in hi-vis lime and hi-vis orange. Does not meet ANSI standards.

20040 - \$9.99



ANSI 107
R2



PIP TWO-TONE CLASS 2 TYPE R SURVEYORS VEST

Durable solid polyester front and breathable mesh back, (6) pockets, zipper closure, 2" two tone tape for optimum visibility. ANSI compliant. Available in sizes M-5XL in hi-vis lime and hi-vis orange.

302-0500 - \$13.99

ANSI 107
R3



PIP CLASS 3 TYPE R 4-POCKETS VALUE MESH VEST

Breathable polyester mesh, 2" silver reflective tape, zipper closure, (2) lower internal pockets, (2) upper chest pockets including (4) pen pockets, ANSI compliant. Available in sizes M-5XL in hi-vis lime and hi-vis orange.

303-MVGZ4P - \$9.99





GLOWEAR CLASS 2 TYPE R BLACK FRONT PERFORMANCE T-SHIRT

Lightweight birds eye knit paired with 2" 3M Scotchlite Comfort Trim. Moisture wicking treatment. 30+ UPF for UV protection. Black front hides dirt and wear. ANSI compliant. Available in sizes S-5XL in hi-vis lime and hi-vis orange.

8280BK - \$22.99



SAFETYGEAR CLASS 2 TYPE R SHORT SLEEVE T-SHIRT

100% polyester micro mesh, lightweight performance wicking material, left upper chest pocket, 2" silver reflective tape, grey collar, ANSI compliant. Available in sizes S-5XL in hi-vis lime and hi-vis orange.

312-1200 Short sleeves - \$13.49

313-1300 - Class 3 long sleeves \$16.79

PIP NON-ANSI SHORT SLEEVE T-SHIRT

Made from 100% polyester birds eye mesh, durable lightweight performance wicking material, and (1) chest pocket. Non-ANSI garments are color enhanced and offer an additional level of safety for low risk activities, but do not meet ANSI standards. Available in sizes S-5XL in hi-vis lime and hi-vis orange.

310-CNTSN Short sleeves - \$8.59

310-1100 Long sleeves - \$11.49



PIP CLASS 3 TYPE R SHORT SLEEVE T-SHIRT

100% polyester micro mesh, lightweight performance wicking material, left upper chest pocket, 2" silver reflective tape, ANSI compliant. Available in sizes S-5XL in hi-vis lime and hi-vis orange.

313-CNTSE - \$13.49



PIP CLASS 3 TYPE R TWO-TONE T-SHIRT

100% polyester micro mesh, lightweight performance wicking material, left upper chest pocket, 2" silver reflective tape, ANSI compliant. Available in sizes S-5XL in hi-vis lime and hi-vis orange.

313-CNTSP - \$14.99



PIP CLASS 2 TYPE R LONG SLEEVE SHIRT

Mesh long sleeve shirt with 50+ UPF sun protection and (1) chest pocket. Available in sizes S-5XL.

312-1350B - \$16.99

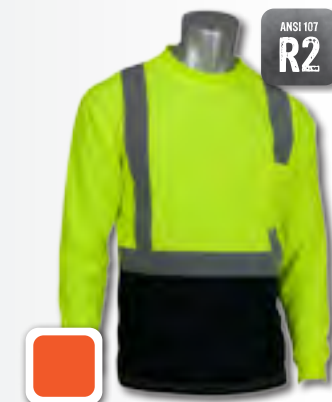



CAROLINA BRUNO WELLINGTON 10" WATERPROOF BOOTS

Comfortable and durable safety footwear for construction and industrial applications. Features folklore leather upper, composite safety toe cap, waterproof scubaliner, pillow cushion insole, removable polyurethane footbed, non-metallic shank, electrical hazard rated, oil and slip resisting rubber outsole. Available in sizes 8-14.

CA2520-200 - \$149.99



CAROLINA BRUNO LOGGER 6" WATERPROOF BOOTS

Comfortable, waterproof, and durable safety footwear for construction and industrial applications. Features copper crazy horse leather upper, composite safety toe cap, waterproof scubaliner, pillow cushion insole, removable polyurethane footbed, non-metallic shank, electrical hazard rated, oil and slip resisting rubber outsole. Available in sizes 7-16.

CA5520-200 - \$144.99



CAROLINA BIRCH 8" WATERPROOF BOOTS

Comfortable and durable safety footwear for construction and industrial applications. Features gaucha crazy horse leather upper, waterproof scubaliner, removable polyurethane footbed, triple-rib steel shank, electrical hazard rated, and leather welt construction. Available in sizes 7-15.

CA7522-210 - \$179.99



CAROLINA BRUNO LOGGER 8" WATERPROOF BOOTS

Comfortable, waterproof, and durable safety footwear for construction and industrial applications. Features copper crazy horse leather upper, composite safety toe cap, waterproof scubaliner, pillow cushion insole, removable polyurethane footbed, non-metallic shank, electrical hazard rated, oil and slip resisting rubber outsole. Available in sizes 8-14.

CA8528-210 - \$159.99

CAROLINA 28 SERIES 6" WATERPROOF BOOTS

Comfortable, waterproof, and durable safety footwear for construction and industrial applications. Features kharthoum cigar leather upper, composite safety toe cap, triple-rib steel shank, removable polyurethane footbed, electrical hazard rated, rubber outsole. Available in sizes 7-15.

CA7528-210 - \$149.99



CAROLINA ELM LOGGER 8" WATERPROOF BOOTS

Comfortable, waterproof, and durable safety footwear for construction and industrial applications. Features copper crazy horse leather upper, composite safety toe cap, waterproof scubaliner, triple-rib steel shank, electrical hazard rated, oil and slip resisting rubber outsole. Available in sizes 7-15.

CA9821-200 - \$139.99



CAROLINA AMP 8" MOC TOE BOOTS

Comfortable, waterproof, and durable safety footwear for construction and industrial applications. Features tobacco stampede leather upper, steel shank, removable polyurethane footbed, electrical hazard rated. Available in sizes 7-14.

CA7002-200 - \$159.99





Try a pair of correctly fitted Oliver Boots for 30 days and, if you are not completely satisfied, return them for exchange or refund.



OLIVER WESTERN STEEL TOE WORK BOOT

This western boot offers safety, comfort, and style. Classic design elements with patterned red stitching, a Goodyear welted construction, and durable pull on loops. The western boot features a removable dual-density poured PU and open cell foam footbed for outstanding cushion, comfort and longevity. Electrical hazard rated outsole and steel toe. Meets ASTM F2413-11 M I/75 C/75 EH. Available in sizes 7.5-11.

OL10001 - \$154.99

OLIVER 8" LACE UP BOOT

Heavy duty all terrain dual density PU / rubber sole. Heat resistant to 572° F. Resists exposure to most acids and chemicals. Natureform wide profile safety toecap. Latex comfort liner to eliminate toe discomfort. Nanolite foot bed massages your feet as you walk to promote blood flow and reduce fatigue. Comfort cushion impact absorption system with poron caustic and water resistant leather. Poron XRD flexible internal metatarsal guard kevlar thread on critical seams. TPU safetycell for maximum protection and durability. Anti-static sole. Lace-in quick release zipper attachment. ASTM F2413-05 I/75 C/75 MT/75. Available in sizes 6-15.

65-392 - \$164.95

OLIVER 6" LACE UP BOOT

Black water resistant full grain leather, comfort cushion system with poron. Heavy duty dual density PU / rubber sole. Heat resistant to 572° F. Resists exposure to most acids and chemicals. Nanolite foot bed massages your feet as you walk to promote blood flow and reduce fatigue. Poron XRD flexible internal metatarsal guard. Flex zero non-metallic penetration protection insole. Tectuff toe bumper and heel protection. Kevlar thread on critical seams. Electrical hazard protection sole. Natureform wide profile AS/NZS 2210.3 Type 1 toe cap protection. Lace locking device. ASTM F2413-11 M I/75 C/75 MT/75 PR and EH. Available in sizes 6-15.

55-246 - \$139.99

OLIVER 6" LACE UP BOOT

Dual density nitrile rubber outer sole with polyurethane mid sole. Comfort cushion uses cellular urethane and poron to protect the heel and ball of the foot. Nanolite foot bed massages your feet as you walk. Water-resistant nubuck leather. Outer sole heat resistant to 572° F surface contact. Heavy duty kevlar stitching across all critical seams. Tectuff toe bumper and heel protection. Lace locking device. Excellent slip resistant sole. Anti-static sole. Padded comfort collar and fully lined tongue. AS/NZS 2210.3 EN ISO 20345:2004. ASTM F2413-05. Available in sizes 6-15.

55-232 - \$129.99



TINGLEY FLITE SAFETY TOE BOOT WITH CLEATED OUTER SOLE

Made from Aerex 1.5.5., a chemical-resistant, insulated, microcellular polymer. Resulting in boots that are over 40% lighter. Lightweight upper, cushioned heel, slip-resistant nitrile rubber outer sole. Composite toe provides superior comfort and safety and meets ASTM F2413 M I/75 C/75 EH. Available in sizes 5-15.

27251 - \$82.99



SERVUS PUNCTURE RESISTANT MIDSOLE

Flexible steel inserts provide puncture protection underfoot. Cushion-covered for improved comfort. Versatile design can be used as a midsole or insole Available in sizes 5-14.

29000 - \$25.00



MUCKBOOT CHORE HI

Stretch-fit topline binding snugs calf to keep warmth in and cold out. 5 mm neoprene bootie with four-way stretch nylon. 100% waterproof, lightweight and flexible. Triple reinforced in the toe area and quadruple reinforced in the heel area. Steel shank for additional arch support. 16" H. Available in sizes 6-16.

CHS000A - \$129.00



CUSTOMIZE YOUR GEAR



Shirts, vests, jackets, helmets, and more. We've made outfitting your crew in identifiable gear easier than ever.

FOLLOW 3 EASY STEPS:

<p>STEP ONE Choose product</p>	<p>STEP TWO Choose colors of product and logo</p>	<p>STEP THREE Choose sizes and quantities</p>
---	--	--

Call a Gear Expert® for pricing.



GME SUPPLY CUSTOM COMPANY LOGO SHIRTS

These high-quality cotton work shirts include your one color (black) company logo on the chest and back for free. Whether you need shirts for one crew or your whole company, the price you pay will be significantly less than buying from your local T-Shirt shop. Ordering is simple. Choose your quantity and upload your logo. Need more than 200? Call for additional quantity discounts. A minimum order of 25 shirts is required for purchase. Available in short sleeve and long sleeve in sizes S-5XL in white, heather gray, hi-viz yellow, and hi-viz orange.

SEE PRICING BELOW

PART	DESCRIPTION	25 QTY	50 QTY	75 QTY	100 QTY	150 QTY	200 QTY
10300	WHITE SHORT SLEEVE	\$9.99	\$7.99	\$6.99	\$6.25	\$5.79	\$5.25
10310	HEATHER GRAY SHORT SLEEVE	\$10.99	\$8.49	\$7.49	\$6.99	\$6.25	\$5.99
10320	HI-VIZ YELLOW SHORT SLEEVE	\$11.49	\$8.75	\$7.75	\$7.25	\$6.49	\$6.25
10330	HI-VIZ ORANGE SHORT SLEEVE	\$11.49	\$8.75	\$7.75	\$7.25	\$6.49	\$6.25
10340	WHITE LONG SLEEVE	\$12.49	\$10.49	\$9.99	\$8.99	\$8.49	\$7.99
10350	HEATHER GRAY LONG SLEEVE	\$12.99	\$10.99	\$10.49	\$9.99	\$9.45	\$8.99
10360	HI-VIZ YELLOW LONG SLEEVE	\$13.49	\$11.49	\$10.99	\$10.49	\$9.99	\$9.49
10370	HI-VIZ ORANGE LONG SLEEVE	\$13.49	\$11.49	\$10.99	\$10.49	\$9.99	\$9.49

† Pricing per shirt



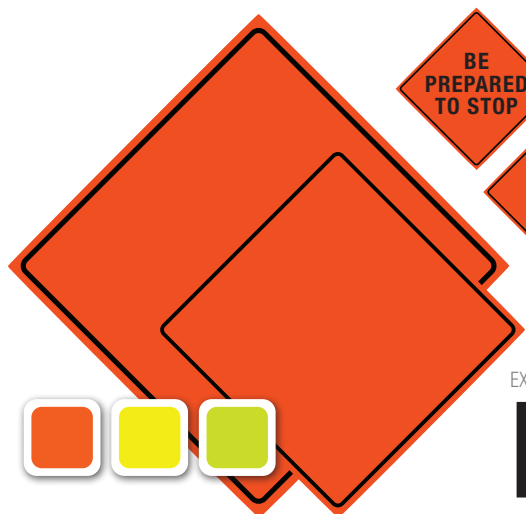

48" x 48" 36" x 36"



EXAMPLE

RE 4848 RCA 0 C

RE MATERIAL TYPE **4848** SIGN SIZE (W x H) **RCA** ACRONYM FOR SIGN **0** COLOR **C** SIGN TYPE

MATERIAL TYPE	SIGN SIZE (W x H)	ACRONYM FOR SIGN	COLOR	SIGN TYPE
SM - Standard mesh	48" x 48"	BPTS - Be prepared to stop	O - Orange	C - Complete
PM - Premium mesh	36" x 36"	DA - Detour ahead	Y - Yellow	
RE - Hi-intensity		FAS - Flagger ahead symbol	L - Lime	
DG - Diamond grade		LC - Lane closed		
		LCA2 - Lane closed ahead		
		LLC - Left lane closed		
		MW - Men working		
		MWS - Men working symbol		
		OLRA - One lane road ahead		
		RC - Road closed		
		RCA - Road closed ahead		
		RLC - Right lane closed		
		RWA - Road work ahead		
		UWA - Utility work ahead		

BONE SAFETY SAFEZONE SIGNS

All of the SafeZone Series signs are made of premium, state-of-the-art materials. For Daytime use we utilize both Standard and Premium Mesh along with superior fade resistant UV stabilizers. For Day or Nighttime usage we recommend our Hi-Intensity material. Pick option from each column to create your own custom sign. If you don't see what your looking for give our Gear Experts® a call.

36" x 36", Standard mesh - \$39.99

36" x 36", Premium mesh - \$43.99

36" x 36", Hi-intensity - \$97.99

36" x 36", Diamond grade - \$143.99

48" x 48", Standard mesh - \$52.99

48" x 48", Premium mesh - \$55.99

48" x 48", Hi-intensity - \$145.99

48" x 48", Diamond grade - \$209.99



CUSTOMIZABLE JOB SITE SAFETY SIGN & PORTABLE BASE

48" x 48" safety sign with 33-3/4" x 14-1/2" base, quickly and easily display OSHA 1910 and 1926 Subpart G required safety signs, made of Premium mesh material to ensure a long life, fade and tear resistant, one banner replaces (12) safety signs, includes custom logo.

2058 With logo - \$229.95

2057 No logo - \$209.95



BONE SAFETY RUBBER BASE SIGN STAND

100% recycled rubber. Tough, lightweight, and stackable. Double grab handles. Quick disconnect mast attachment. 38 lbs.

RBS - \$96.99



BONE SAFETY DUAL COIL SPRING SIGN STAND

Easy storage, pull pin and kick release of legs. (3) Separate height adjustments for uneven terrain. Bright orange legs for extra visibility on curbs and sidewalks. Outdoor UV powder-coated and zinc plated for maximum corrosion resistance. 31 lbs.

412-2S - \$138.99



BONE SAFETY SINGLE SPRING SIGN STAND

Lightweight, pull pin and kick release of legs. (3) separate height adjustments for uneven terrain. Bright orange colored legs for extra visibility on curbs and sidewalks. Powder-coated and zinc plated for maximum corrosion resistance. 23 lbs.

412-S Spring stand - \$101.99

412 Springless stand - \$96.99



CORTINA VINYL PENNANTS

60 pennants, 12" H, 9" W, 100' overall length, orange.

03-402 Orange - \$8.99

03-401 Red & White - \$7.99

03-400 Red - \$7.99



CORTINA PLASTX BARRICADES

Available in a variety of industry-standard signage. Recessed light bracket to protect from impact. Replaceable panels available. Recessed panel area provides protection. Superior high-strength resin withstands temperature extremes and has UV protection for year-round use.

13-01-010 Barricade - \$40.99

13-01-010AL "This Way" with left arrow sign - \$12.99

13-01-010AR "This Way" with right arrow - \$12.99

13-01-010C "Caution" - \$12.99

13-01-010DH "Danger High Voltage" - \$12.99

13-01-010DL "Detour" with left arrow - \$12.99

13-01-010DR "Detour" with right arrow - \$12.99

13-01-010DOP "Danger Overhead Power Lines" - \$12.99

SC "Sidewalk Closed" - \$12.99



CORTINA 42" FLARED DELINEATOR POST

10 lb rubber base, (2) 3" reflective collars, EZ-Grab handle, 100% impact-resistant low-density polyethylene construction.

03-734RBC - \$39.99

03-732 Post - \$28.99

03-730 Base - \$12.99



WORK AREA 42" CHANNELIZER CONE

High-Impact, low density polyethylene with reinforced loop handle, (4) Hi-Intensity reflective stripes, includes CB16 16 lb base.

CC42 4-4HIP W/ CB16 - \$44.99



CORTINA WARNING DIAMOND MESH FENCING

4' x 100', orange polyethylene, highly visible, UV stabilized, rugged and reusable, 23 lbs per roll, made in the USA.

03-901 - \$74.99

Qty 10+ - \$59.95



CORTINA TRIANGLE WARNING KIT

Highway triangle warning kit, meets FMVSS 125, SAE-W4-74DOT, acrylic plastic strip reflectors, effective even for daytime use, impervious to dust and moisture, easy to unfold and mount on base, exceeds 40 mph wind test, custom hard plastic storage case included, fits under most vehicle seats.

95-03-009 - \$39.99



CORTINA VINYL FLAT

Handheld warning flag, 18" flag with 36" wooden dowel, reinforced heavy duty warning flag, fluorescent red-orange, ideal for directing traffic or warning motorists of upcoming construction.

03-229-3405 - \$3.39



PIP FLASH BATON

Economical battery operated baton or light wand uses bright LEDs to identify hazardous conditions or dangerous areas. User can switch from red flashing light to red steady light. Ideal for police, firefighters, airport workers, traffic controllers, parking valets, construction workers and other public safety personnel. Includes carrying strap and attachment clip. Operates on (2) "C" batteries.

935-004 16" - \$4.99

935-006B 22" - \$7.99





DICKE SAFETY 18" STOP/SLOW PADDLE

High intensity reflective plastic, ABS orange 12" handle, meets all MUTCD specifications, unique snap together handle.

- P18HIA 12" Handle - \$48.49
- P24HIA 24" Handle - \$69.99
- P51A 5' Handle extension - \$14.99
- P61A 6' Handle extension - \$15.99
- P52AT Telescoping handle - \$24.99



AERVOE 28" COLLAPSIBLE TRAFFIC SAFETY CONE

2.5 lb weighted base, 2 reflective stripes, blinking red LED beacon, includes storage case.

- 1191 1 Pack - \$30.99
- 1192 3 Pack - \$78.99



WORK AREA 28" TRAFFIC SAFETY CONE

6" and 4" reflective collars, 7 lb overall weight, all vinyl construction, ultraviolet stabilized color, high density base, low center of gravity for maximum stability, stackable.

- 28PVCTLS-6CC4CC - \$24.99



WORK AREA TRAFFIC SAFETY CONE

Fluorescent orange color, made from PVC, high density base, low center of gravity for maximum stability, stackable.

- 12PVGS-271452 12" - \$6.99
- 18PVGS-6CC 18" - \$8.99



JOHNSON "CAUTION" WARNING TAPE

High-visibility colors, easy to read black print, made from durable plastic.

- 3321 Yellow "Caution" 300' x 3" - \$6.95
- 3324 Yellow "Caution" 1,000' x 3" - \$12.95
- 3322 Red "Danger Do Not Enter" 300' x 3" - \$6.95
- 3331 Red "Danger Do Not Enter" 1,000' x 3" - \$13.30



CONE SIGNS

Firmly mounts to top of cone, two sided, fits in any flexible traffic cone, rugged plastic sign, weather and fade resistant, safety orange with black text. 10" x 14".

- FBC756 No parking - \$23.99
- FBC737 Sidewalk closed - \$23.99



AERVOE SURVEY MARKING PAINT

17 oz aerosol, lead free. Marking paint that will last up to 6 months. Non-freezing. Exceptional quality in terms of initial color brightness, color retention, adhesion, durability, and color consistency. APWA/OSHA colors.

- AV-207 White - \$4.99
- AV-222 Fluorescent orange- \$4.99
- AV-226 Fluorescent yellow - \$4.99
- AV-229 Fluorescent pink - \$4.99



TEMPORARY TRAFFIC CONTROL POCKET REFERENCE GUIDE

Help protect workers from construction work zone hazards. Bring work zones into compliance with Federal and State DOT requirements and OSHA standards. Based on the current Federal MUTCD. 80 thick, laminated, "field durable" pages. Quick reference charts, tables, and drawings. 7" x 3-5/8".

- PRG4A - \$16.75



VEHICLE EMERGENCY ROADSIDE KIT

13.25" L, 5" H, 11" W. (65) pieces. Stay safe on the road with the PhysiciansCare ready-to-go emergency vehicle kit. The right mix of tools and first aid to keep you and your car moving forward. Kit includes: duct tape, booster cables, 8" warning triangle, cable ties, screw driver, pressure gauge, bungee cord, personal first aid kit, nitrile exam gloves, carton cutters, poncho, flashlight, AA batteries, 52" x 84" aluminized rescue blanket.

- 90311 - \$78.99





MOTIVATIONAL WORKPLACE BANNER

4' x 2' vinyl banner; designed to remind and encourage safety in any workplace. High contrast signs are easy to read and visible from a distance. Made of premium extra-heavy duty UltraFlex 15 oz PVC material. Capable of withstanding harsh outdoor environments. Fade, tear, fungus, and scratch resistant. Stable down to -20°F. Grommets allow for convenient hanging. Many designs available or customize your own!

2074 "Safety Is No Accident" - \$29.99

2083 "American Tower Climbers" - \$29.99

2070C Custom design, submit your print ready artwork - \$49.99



CUSTOMIZABLE JOB SITE SAFETY BANNER WITH POCKETS

5' x 3.5' vinyl safety sign banner, quickly and easily display OSHA required safety signs. (3) Heavy-duty pockets for convenient display of documents. Made of premium extra-heavy duty UltraFlex 15 oz PVC material, capable of withstanding harsh outdoor environments. Fade and tear resistant. Outstanding scratch resistance. Stable down to -20°F. Treated for fungus resistance. Grommets allow for convenient hanging.

2025 With logo - \$149.99

2020 No logo - \$129.99



CUSTOMIZABLE JOB SITE SAFETY BANNER

Vinyl safety sign banner, quickly and easily display OSHA required safety signs, made of premium extra-heavy duty UltraFlex 15 oz PVC material. Capable of withstanding harsh outdoor environments. Fade and tear resistant. Outstanding scratch resistance. Stable down to -20°F. Treated for fungus resistance. Grommets allow for convenient hanging.

2000 No logo (4' x 2') - \$29.99

2005 With logo (4' x 2') - \$49.99

2010 No logo (6' x 3') - \$49.99

2015 With logo (6' x 3') - \$99.99



2301

FOLD UP JOB SITE SIGN

25" x 45" portable sign is made from 100% premium grade plastic for durability. Made for outside use at the job site. Molded handle allows for easy portability. Weighs 21 lbs and can be weighed down internally with an additional 5 lbs of sand. Sign area 24" x 36". Many designs available or customize your own!

2301 "Danger Workers Above / Caution" - \$149.99

2304 "Do Not Enter" - \$149.99

2310 Custom logo, tower job site signs - \$174.99

2313 Custom design, submit your print ready artwork - \$174.99



2304



2310



RADIO FREQUENCY SIGNS

18" H x 12" W. Post sign to warn workers to use caution where radio frequency could exceed the FCC rules for human exposure.

GM1218 Notice, adhesive vinyl - \$9.99

GW1218 Notice, aluminum - \$19.99

GMC121 Caution, adhesive vinyl - \$9.99

GCA121 Caution, aluminum - \$19.99

GWA121 Warning, adhesive vinyl - \$9.99

GMW121 Warning, aluminum - \$19.99



COMBO OSHA SAFETY POSTER

40" H x 27" W. Combo state, federal, and OSHA labor law posters. Available with applicable standards for all fifty states. Hang this poster to alert workers to follow all laws and regulations. Add two letter state abbreviation to part number to specify state.

PPG300 English - \$48.00

PPG400 Spanish - \$48.00



NOTICE SIGN FOR RADIO FREQUENCY ENVIRONMENTS

8" H x 12" W. Sign serves to notify those working in an area where radio frequency is or could be present. Spanish versions also available.

GMA812 Aluminum - \$9.98

GMV812 Adhesive vinyl - \$5.49



CUSTOMIZABLE JOB SITE INFO SIGN

8" H x 12" W. Display company or carrier information, site ID, and phone number. Sign notifies workers who operates the site and provides contact information.

GMIN81 Adhesive vinyl - \$5.49



MSMK403VP



MCSPI34VP



MFVG588VP



MSMK133



MSTF661VP



MELC114VP



MEXT906VP



MEQM152VP



MEXT911VP

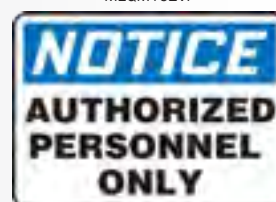

MADC801VP



MPPA801VP

ACCIFORM PLASTIC SIGNS

10" H x 14" W. Made from plastic and displays. (4) pre-drilled corner holes and rounded corners.

MCSPI34VP Danger confined space enter by permit only - \$12.99

MSMK133 Danger no smoking - \$12.99

MELC114VP Danger high voltage - \$12.99

MEQM152VP Danger this machine starts and stops automatically - \$12.99

MADC801VP Notice authorized personnel only - \$12.99

MPPA801VP Notice safety glasses required in this area - \$12.99

MSMK403VP Designated smoking area - 12.99

MFVG588VP Fire extinguisher - \$12.99

MSTF661VP Caution watch your step - \$12.99

MEXT906VP Exit - \$12.99

MEXT911VP Not an exit - \$12.99

Quantity discounts available for all signs!
Call (800) 940-6762



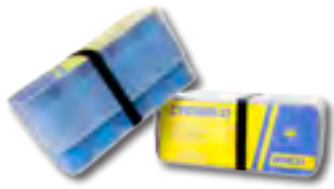

WELD METAL

Cadweld weld metal is a mixture of copper oxide and aluminum, packaged by size in plastic tubes. Each tube contains the starting powder at the bottom of the plastic tube, with the weld metal on top. These containers are packaged, with metal disks, in polyethylene boxes. The welding metal cannot ignite spontaneously. They can be handled and stored without danger and can be shipped with no special packaging or marking.

PART	WELD METAL	CASE QTY	PRICE
#32-CASE	#32	20	\$55.00
#45-CASE	#45	20	\$79.00
#65-CASE	#65	20	\$90.00
#90-CASE	#90	10	\$65.00
#115-CASE	#115	10	\$85.00
#150-CASE	#150	10	\$110.00
#200-CASE	#200	10	\$135.00

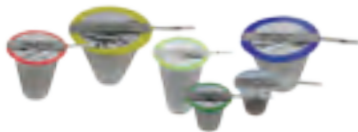

PLUS WELD METAL

Cadweld Plus weld metal consists of disposable, moisture resistant weld metal cup. Weld metal, disk, and ignition source are located inside package. No need for disks, starting materials, igniters etc. Reduce installation time by 20%. Use ordinary Cadweld molds and get perfect results every time. Using the electronic ignitor, welds are made with the installer 6 feet away.

PART	WELD METAL	CASE QTY	PRICE
#32PLUS-CASE	#32	20	\$59.85
#45PLUS-CASE	#45	20	\$82.25
#65PLUS-CASE	#65	20	\$102.35
#90PLUS-CASE	#90	10	\$71.25
#115PLUS-CASE	#115	10	\$89.25
#150PLUS-CASE	#150	10	\$111.75
#200PLUS-CASE	#200	10	\$138.65



CABLE TO CABLE MOLD

Forms a permanent low resistance connection and provides molecular bond. Exothermic connections are rated with the same current capacity as the conductor and can be visually inspected. Portable installation equipment with no external source of power required. Uses #65 weld metal.

PTP-1T1T - \$136.99



GO TO WWW.GMESUPPLY.COM/GROUNDING
TO VIEW ENTIRE GROUNDING SELECTION ONLINE

KITS
SAVE
CASH

VIDEO



CADWELD PLUS ELECTRONIC EXOTHERMIC WELDING DELUXE KIT

Kit includes PLUSCU Cadweld electronic control unit, L160 standard handle with flint igniter, B160V chain handle with flint igniter, #45 case weld metal (20 shots), (2) #65 cases weld metal (40 shots), #90 case weld metal (10 shots), PTC-1T1T 2 solid parallel splice mold, TAC-1T1T solid "T" mold, LJC-EG1T 2 solid bus bar mold, GTC-161T 2 solid through 5/8" ground rod mold, VSC-1T-V3C 2 solid vertical down from pipe mold, VFC-1T-V3C 2 solid vertical up from pipe mold, HAA-1T solid horizontal to flat steel mold, T394 mold cleaning brush, T403 mold sealer.

8075 - \$1,199.99



VIDEO

CADWELD EXOTHERMIC WELDING DELUXE KIT

Kit includes L160 standard handle with flint igniter, B160V chain handle with flint igniter, #45 case weld metal (20 shots), (2) #65 cases weld metal (40 shots), #90 case weld metal (10 shots), PTC-1T1T 2 solid parallel splice mold, TAC-1T1T solid "T" mold, LJC-EG1T 2 solid bus bar mold, GTC-161T 2 solid through 5/8" ground rod mold, VSC-1T-V3C 2 solid vertical down from pipe mold, VFC-1T-V3C 2 solid vertical up from pipe mold, HAA-1T solid horizontal to flat steel mold, T394 mold cleaning brush, T403 mold sealer.

8051 - \$1,099.99



CADWELD 8025 WELDING STARTER KIT

Kit includes L160 EZ-change 3" handle clamp, PTC-1T1T solid parallel splice mold, TAC-1T1T solid "T" mold, LJC-EG1T solid bus bar mold, GTC-161T solid through 5/8" ground rod mold, #45 case weld metal (20 shots), #65 cases weld metal (40 shots), #90 case weld metal (10 shots), T394 mold cleaning brush, T403 mold sealer.

8025 - \$649.99



CADWELD 8035 WELDING STARTER KIT

Kit includes B160V chain handle with flint igniter, VSC-1T-V3C solid vertical down from pipe mold, VFC-1T-V3C solid vertical up from pipe mold, #45 case weld metal (20 shots), #65 cases weld metal (40 shots), HAA-1T solid horizontal to flat steel mold, T394 mold cleaning brush, T403 mold sealer.

8035 - \$519.99

ERICO

ERICO is the pioneer of the CADWELD Exothermic Welding Process for permanent Cathodic Protection connections. Specifying the CADWELD process in your construction plans will dramatically extend the lifespan of infrastructure systems. CADWELD connections are made with a semi-permanent graphite mold, which holds the conductors to be welded. Weld metal (a mixture of copper oxide and aluminum) is dumped into the top of the mold. The mold is covered and the weld metal ignited. The exothermic reaction produces molten copper, which results in a permanent, high conductivity connection. A CADWELD Connection has current carrying capacity equal to that of the conductor, is permanent with a low resistance connection that cannot loosen or corrode, uses lightweight, inexpensive equipment, requires no external source of power or heat, and can be easily checked for quality.





BOTTOM FEED CABLE TO VERTICAL PIPE DOWN



CABLE TO STEEL



RUN & TAP OR 3-WAY

Many more options available. Call a Gear Expert® for more information.

PETRILLA 2W LOW POWER TERMINATION LOADS



VIDEO

PETRILLA HIGH POWER TERMINATION LOADS

Available in 4.3/10, 7/16" DIN, and N.



VIDEO



PETRILLA HIGH GRADE LOW PIM JUMPERS

Ideal for test applications where superior quality is required. Available in 4.3/10, 7/16, N, 4.1/9.5, QMA, or SMA. Frequency: DC -6000 MHz. PIM: < -160 dBc. Shielding: 100 dBc. Operating temperature: -65°C to 165°C. Impedence: 50 Ω.

DIN FEMALE CAP KITS

Corrosion resistant. IP67 Rated. Temperature Rated: -40°C± 85°C. 100 / case.

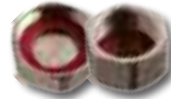

COAX SUPPORT BLOCKS

Durable UV resistant polypropylene material. Interior rib construction offers better cable retention. Holes accommodates common hardware. Kit of 10.

SQUARE GALVANIZED WASHERS

Galvanized steel construction. 50 / pack.



STAINLESS STEEL HOSE CLAMPS

Marine Grade 304 Stainless Steel hose clamps. Round member adapters. Kit of 10.

STRUT END CAPS

Compatible with 7/8" and 1-5/8" strut. Vinyl plastic composition. Safety cap to prevent cuts to installers. 100 / pack.



THREADED ROD SAFETY CAPS

Vinyl safety caps for threaded rod. Kit of 100.

GALVANIZED SPRING NUTS

Galvanized steel construction. Spring coil Individually wrapped in plastic to eliminate damage. 100 / pack.



COAX BLOCK HARDWARE KITS

Available in both galvanized and stainless steel. Each Kit contains 30 flat washers, 30 lock washers, 30 hex nuts, 10 pieces of 3/8" threaded rod.

MOLD SEALER

Ideal for sealing hot or cold molds to prevent leakage during welding.

T403 - \$19.99



ELECTRONIC IGNITER

Initiates the reaction of the metal crucible, includes a 6' lead that attaches to the ignition strip and 8 AA batteries.

PLUSCU - \$144.99



HANDLE CLAMP

Used for most molds, includes flint igniter. Offset handle reduces labor time and can fit in a smaller hole.

L159 3" - \$54.99

L160 4" - \$60.99



CHAIN HANDLE CLAMP

Secure molds to vertical pipe, 20" chain for pipes up to 4", includes flint igniter, can be used with or without chain.

B160V - \$129.99

B158 20" extension chain - \$16.35



CATHODIC PROTECTION ADAPTER SLEEVE

Used to build up smaller cathodic protection conductors for a proper fit into the required mold.

CAB1331H - \$1.00



FLINT IGNITER

Available separately, but included with each handle clamp.

T320 - \$6.99

T320A Replacement flints (10 pack) - \$5.95



ADAPTER SLEEVES

Changes 2 stranded molds to 6 stranded, 25 pack.

B112 - \$6.99

B140A Wrap sleeves (50 pack) - \$32.00



MOLD CLEANING BRUSH

Useful in removing slag from molds, especially vertically split.

T394 - \$7.79





ONE HOLE LUGS WITHOUT INSPECTION WINDOW

UL and CUL listed. High conductivity seamless copper construction. Tin plated. Long barrel. CSA certified.

PART	GAUGE	STUD SIZE	COLOR	PRICE
8-14	#8	1/4"	Red	\$1.85
6-14	#6	1/4"	Blue	\$2.00
6-38	#6	3/8"	Blue	\$2.00
2S-38	2 Solid, #3, #4	3/8"	Grey	\$2.40
2-14	#2	1/4"	Brown	\$2.40
2-516	#2	5/16"	Brown	\$2.40
6-516	#6	5/16"	Blue	\$2.00
2-38	#2	3/8"	Brown	\$2.40



ONE HOLE LUGS WITH INSPECTION WINDOW

UL and CUL listed. High conductivity seamless copper construction. Tin plated. Long barrel. CSA certified.

PART	GAUGE	STUD SIZE	COLOR	PRICE
i1410	#14 - #10	1/4"	Yellow	\$1.85
i8-14	#8	1/4"	Red	\$2.10
i6-14	#6	1/4"	Blue	\$2.00
i6-38	#6	3/8"	Blue	\$2.00
i2S-38	2 Solid, #3, #4	3/8"	Grey	\$2.40
i2-14	#2	1/4"	Brown	\$2.40
i2-516	#2	5/16"	Brown	\$2.40
i2-38	#2	3/8"	Brown	\$2.40



TWO HOLE LUGS WITHOUT INSPECTION WINDOW

UL and CUL listed. High conductivity seamless copper construction. Tin plated. Long barrel. CSA certified.

PART	GAUGE	STUD SIZE	HOLE SPACING	COLOR	PRICE
1410-14	#14 - #10	1/4"	5/8" (.625)	Yellow	\$2.00
1410-25-1	#14 - #10	1/4"	1"	Yellow	\$2.00
1410-38-1	#14 - #10	3/8"	1"	Yellow	\$2.00
82-14	#8	1/4"	5/8" (.625)	Red	\$2.10
82-10	#8	#10	5/8" (.625)	Red	\$2.10
62-14	#6	1/4"	5/8" (.625)	Blue	\$2.40
62-34	#6	1/4"	3/4" (.75)	Blue	\$2.40
62-25-1	#6	1/4"	1"	Blue	\$2.40
62-38-1	#6	3/8"	1"	Blue	\$2.40
2S2-14	2 Solid, #3, #4	1/4"	5/8" (.625)	Grey	\$2.85
2S2-38-1	2 Solid, #3, #4	3/8"	1"	Grey	\$2.85
22-14	#2	1/4"	5/8" (.625)	Brown	\$2.85
22-34	#2	1/4"	3/4" (.75)	Brown	\$2.85
22-25-1	#2	1/4"	1"	Brown	\$2.85
22-38-1	#2	3/8"	1"	Brown	\$2.85



TWO HOLE LUGS WITH INSPECTION WINDOW

UL and CUL listed. High conductivity seamless copper construction. Tin plated. Long barrel. CSA certified.

PART	GAUGE	STUD SIZE	HOLE SPACING	COLOR	PRICE
i1410-14	#14 - #10	1/4"	5/8" (.625)	Yellow	\$2.00
i1410-25-1	#14 - #10	1/4"	1"	Yellow	\$2.00
i1410-38-1	#14 - #10	3/8"	1"	Yellow	\$2.00
i82-14	#8	1/4"	5/8" (.625)	Red	\$2.10
i82-10	#8	#10	5/8" (.625)	Red	\$2.10
i62-14	#6	1/4"	5/8" (.625)	Blue	\$2.40
i62-25-1	#6	1/4"	1"	Blue	\$2.40
i62-38-1	#6	3/8"	1"	Blue	\$2.40
i2S2-14	2 Solid, #3, #4	1/4"	5/8" (.625)	Grey	\$2.85
i2S2-38-1	2 Solid, #3, #4	3/8"	1"	Grey	\$2.85
i22-14	#2	1/4"	5/8" (.625)	Brown	\$2.85
i22-34	#2	1/4"	3/4" (.75)	Brown	\$2.85
i22-25-1	#2	1/4"	1"	Brown	\$2.85
i22-38-1	#2	3/8"	1"	Brown	\$2.85



UNIVERSAL TWO HOLE LUGS WITHOUT INSPECTION WINDOW

UL and CUL listed. High conductivity seamless copper construction. Tin plated. Long barrel. CSA certified.

PART	GAUGE	STUD SIZE	HOLE SPACING	COLOR	PRICE
62-38U	#8	3/8" slotted	3/4" - 1"	Blue	\$2.40
2S2-38U	2 Solid, #3, #4	3/8" slotted	3/4" - 1"	Grey	\$2.85
22-38U	#2	3/8" slotted	3/4" - 1"	Brown	\$2.85



UNIVERSAL TWO HOLE LUGS WITH INSPECTION WINDOW

UL and CUL listed. High conductivity seamless copper construction. Tin plated. Long barrel. CSA certified.

PART	GAUGE	STUD SIZE	HOLE SPACING	COLOR	PRICE
i62-38U	#6	3/8" slotted	3/4" - 1"	Blue	\$2.40
i2S2-38U	2 Solid, #3, #4	3/8" slotted	3/4" - 1"	Grey	\$2.85
i22-38U	#2	3/8" slotted	3/4" - 1"	Brown	\$2.85
i1410-14U	#14 - #10	1-4" slotted	1-2" - 5/8"	Yellow	\$2.00





NYLON ZIP TIES

UL listed. Self-locking nylon cable ties. UV resistant. Plenum rated. Sold in 50 lb, 120 lb, or 350 lb test. 100 / bag.

PART	SIZE	TEST	PRICE
IZ-7-50	7" long	50 lb test	\$5.00
IZ-11-50	11" long	50 lb test	\$6.50
IZ-14-50	14" long	50 lb test	\$8.00
IZ-17-50	17" long	50 lb test	\$9.50
IZ-14-120	14" long	120 lb test	\$10.00
IZ-18-120	18" long	120 lb test	\$12.00
IZ-24-250	24" long	350 lb test	\$35.00



HOOK & LOOP CABLE TIE WRAPS

Easy installation. Hook and cinch design. May be readjusted and reused. Compare to Velcro brand. 100 / pack.

PART	SIZE	PRICE
VEL-050X8-BLACK	1/2" x 8"	\$27.50
VEL-050X12-BLACK	1/2" x 12"	\$30.00
VEL-075X8-BLACK	3/4" x 8"	\$32.50
VEL-075X12-BLACK	3/4" x 12"	\$35.00



HEAT SHRINK

UV Resistant, flame retardant. Operating temp: -55°C to +125°C. Minimum shrink temp: 70°C. Minimum full recovery temp: 110°C. Shrink ratio 3:1. RoHS compliant. Meets SAE-AMS-DTL-23053/5 Class 1 3. Cross linked adhesive lined polyolefin. Excellent sealing and insulation properties. 4' long adhesive lined sticks. Sold by the case.

PART	SIZE	COLOR	QUANTITY	PRICE
HS-.25X48	.25" x 48" with Adhesive	Black	100 / case	\$300.00
HS-.50X48	.50" x 48" with Adhesive	Black	100 / case	\$450.00
HS-.75X48	.75" x 48" with Adhesive	Black	100 / case	\$625.00
HS-1.5X48	1.50" x 48" with Adhesive	Black	20 / case	\$265.00

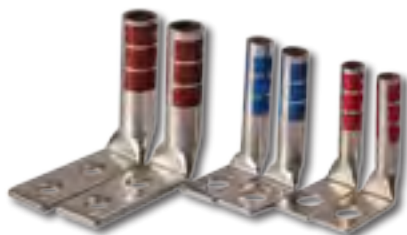

90° RIGHT ANGLE LUGS

UL and CUL listed. High conductivity seamless copper construction. Tin plated. Long barrel. CSA certified.

PART	GAUGE	LENGTH	DESCRIPTION	COLOR CODE	PRICE
R8-14	#8	1/4"	One hole, without inspection window	Red	\$1.90
R8-14i	#6	1/4"	One hole, with inspection window	Red	\$1.90
i6-14R	#6	1/4"	One hole, with inspection window	Blue	\$1.80
i22-14R	#2	1/4"	Two hole, with inspection window (5/8" hole spacing)	Brown	\$2.70
22-34R	#2	1/4"	One hole, without inspection window (1/4" hole, 3/4" hole spacing)	Brown	\$2.70



GO TO WWW.GMESUPPLY.COM/CONSUMABLES
TO VIEW ENTIRE CONSUMABLE OPTIONS ONLINE



IZZY HAND RATCHETING CRIMPING TOOL

Color coded rotating die. Die includes 5 cavities: #10-#14, #2, 2 solid (includes #3 & #4), #6 and #8 awg.

IL-CRIMPER - \$304.99



CABLE TRAY JUMPERS

9", 6 AWG THHN green wire. 2 hole configuration. 1/4" or 3/8" stud sizes. Connection is weatherproofed with UL listed heat shrink.

PART	LUG TYPE	STUD SIZE	HOLE SPACING	PRICE
CT6214	2 hole	1/4"	5/8"	\$9.50
CT6238	2 hole	3/8"	1"	\$9.50



BARREL SPLICE LUGS

UL and CUL listed. High conductivity seamless copper construction. Tin plated. Long barrel. CSA certified.

PART	GAUGE	LENGTH	COLOR CODE	PRICE
8BS	#8	2-1/4"	Red	\$2.00
6BS	#6	2-1/4"	Blue	\$2.00
2SBS	2 Solid, #3, #4	2-3/8"	Grey	\$2.25
2BS	#2	2-1/2"	Brown	\$2.25





PETRILLA CLAMPRO GEL WEATHERPROOF PROTECTION

These reusable clamshell weather enclosures rapidly make your connection IP-68 protected. Uses a gel technology to lock moisture out.

PART	DESCRIPTION	PRICE
PET-WEA-12AND	1/2" to antenna. For 7/16 DIN connections.	\$12.99
PET-WEA-12AN43	1/2" to antenna. For 4.3/10 connections.	\$12.99



PETRILLA BARREL CUSHIONS

10 / pack.

PART	DESCRIPTION	PRICE
PET-PB-78CSH58	7/8" grommet with 5/8" hole. For power cable.	\$14.99
PET-PB-16CSH68	16 mm grommet with 8 mm hole. For fiber, #6, or RET. Fits PET-PB-16 hanger.	\$14.99
PET-PB-13CSH6	13 mm grommet with 6 mm hole. For fiber or #6. Fits PET-PB-13 hanger.	\$12.99
PET-PB-10CSH5	10 mm grommet with 5 mm hole. Fits PET-PB-10 hanger.	\$12.99



PETRILLA ALLTHREAD HANGER HARDWARE KITS

All kits include (10) rods, (20) nuts, (20) lock washers, and (2) flat washers.

PART	DESCRIPTION	PRICE
PET-HDW-38KIT2-04	3/8" x 4" stainless steel threaded rod	\$18.99
PET-HDW-38KIT2-06	3/8" x 6" stainless steel threaded rod	\$19.99
PET-HDW-38KIT2-08	3/8" x 8" stainless steel threaded rod	\$20.99
PET-HDW-38KIT2-10	3/8" x 10" stainless steel threaded rod	\$23.99
PET-HDW-38KIT2-12	3/8" x 12" stainless steel threaded rod	\$26.99



3M SLIM LOCK CLOSURE 716

Protects RF connections at the antenna and remote radio units. Displaces air around the cable and connector. Clamshell-like design of the closure allows re-entry, enabling repeated use of the closure. 1/2" jumper coax cable with DIN 716 connections. Used with cables with 0.53" - 0.63" in diameter. RoHS 2011/65/EU compliant.

3M-SLC-716 - \$24.99



BIRD TECHNOLOGIES LOAD RESISTOR

75 watt, 2.4 GHz. Air load coolant type. N female connector. RF coaxial load for transmitter termination or testing. Extremely low VSWR. Dry load can be operated in any position.

47508 - \$169.00



PETRILLA BLOCK-TYPE CABLE HANGERS

All blocks are designed with mounting holes for 3/8" threaded rod. 10 / pack.

PART	DESCRIPTION	PRICE
PET-PB-06	Dual 6 mm cable hanger. For #6 AWG.	\$9.99
PET-PB-10	Dual 10 mm cable hanger. For RET cables, #2 AWG, or LMR400 cable.	\$9.99
PET-PB-13	Dual 13 mm cable hanger. Use with fiber grommet or 1/2" superflex coax.	\$10.99
PET-PB-16	Dual 16 mm (1/2") cable hanger. Use with 1/2" standard coax.	\$10.99
PET-PB-58	Dual 5/8" cable hanger	\$12.99
PET-PB-78	Dual 7/8" cable hanger	\$12.99
PET-PB-114	Dual 1-1/4" cable hanger	\$17.99
PET-PB-158	Dual 1-5/8" cable hanger	\$18.50
PET-PB-214	Dual 2-1/4" cable hanger	\$24.99



PETRILLA INNERDUCT HANGERS

All blocks are designed with mounting holes for 3/8" threaded rod. 10 / pack. Operating temperature: -40°C to +85°C. UV resistance: ≥100 hours in accelerated UV life chamber. Vibration: ≥4 hours survival at resonant frequency.

PART	DESCRIPTION	PRICE
PET-PB-11D	1" to 1-1/4" innerduct hanger.	\$22.99



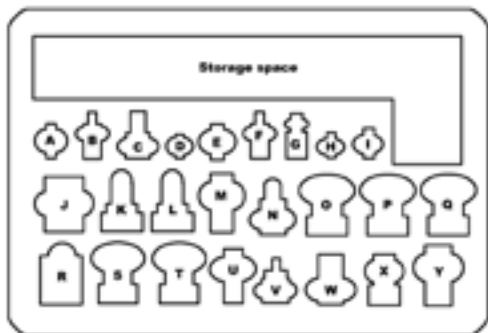

PETRILLA COMPREHENSIVE 23-PIECE ADAPTER KIT

7/16 DIN, N, 4.3/10, SMA, QMA. Comes in a water-proof, crush-proof case. Handle and strap on case for easy transportation.

- (A) QMA M to SMA F
- (B) QMA M to N F
- (C) QMA M to N M
- (D) SMA F to SMA F
- (E) SMA M to SMA M
- (F) SMA F to N F
- (G) SMA M to N F
- (H) Spare
- (I) Spare
- (J) 7/16 DIN M to 7/16 DIN M
- (K) 7/16 DIN M to N F
- (L) 7/16 DIN F to N F
- (M) N M to N M
- (N) SMA M to N M
- (O) 4.3/10 M to 7/16 DIN F
- (P) 4.3/10 F to 7/16 DIN M
- (Q) 4.3/10 M to 4.3/10 M
- (R) 7/16 DIN F to 7/16 DIN F
- (S) 7/16 DIN M to N M
- (T) 7/16 DIN F to N M
- (U) N F to N F
- (V) SMA F to N M
- (W) 4.3/10 F to N F
- (X) 4.3/10 M to N F
- (Y) 4.3/10 F to 4.3/10 F

PET-ADPKIT-23A - \$699.99



PETRILLA LOW PIM 4.3/10 TO 7/16 ADAPTER KIT

8-piece set. Average PIM -165 dBc. Silver plated. Durable water-proof, crush-proof case. Kit includes: 4.3/10 M to 7/16 DIN F, 4.3/10 F to 4.3/10 F, 4.3/10 F to N F, 7/16 DIN F to 7/16 DIN, 4.3/10 F to 7/16 DIN M, 4.3/10 M to 4.3/10 M, 4.3/10 M to N F, 7/16 DIN M to 7/16 DIN.

PET-ADPKIT-43D - \$499.99



PETRILLA LOW PIM DIN/N ADAPTER KIT

8-piece set. Average PIM between 155 dBc and -160 dBc. Silver plated. Durable water-proof, crush-proof case. Kit includes: N F to N F, 7/16 DIN F to N, 7/16 DIN M to N F, 7/16 DIN F to 7/16 DIN, N M to N M, 7/16 DIN F to N, 7/16 DIN M to N, 7/16 DIN M to 7/16 DIN.

PET-ADPKIT-DN - \$499.99





COMPLIES WITH
FAA STANDARD



**TOWERPLEX AVIATION
WHITE TOWER PAINT**

100% acrylic emulsion coating formulated for use on galvanized antenna towers, dries quickly and has excellent weathering properties, meets Federal Standard 595 color #17875 White and complies with National Bureau of Standards report NBS1R75-663 and F.A.A. A/C70/7460-1H.

CC2919 1 Gallon - \$39.99

CC2919A 5 Gallons - \$179.99

**TOWERPLEX
ACRYLIC BONDING PRIMER**

100% pure acrylic emulsion maintenance/shop primer that develops barrier corrosion resistance, normally associated only with solvent-borne primers. This primer offers excellent adhesion to various substrates such as structural steel, aluminum, galvanized, concrete, masonry, and wood.

CC2925 1 Gallon - \$64.99

CC2925A 5 Gallons - \$289.99

**TOWERPLEX AVIATION
ORANGE TOWER PAINT**

100% acrylic emulsion coating formulated for use on galvanized antenna towers, dries quickly and has excellent weathering properties, meets Federal Standard Color #12197 Orange and complies with National Bureau of Standards report NBS1R75-663 and F.A.A. A/C70/7460-1H.

CC2920 1 Gallon - \$49.99

CC2920A 5 Gallons - \$229.99



**FAA IN-SERVICE ORANGE
COLOR RANGE CHART**

By visually comparing the chart to the tower by way of the window on each page, one can determine whether it is necessary to repaint the tower or obstruction to bring the markings back into compliance. The chart is comprised of 18 technically matched and certified color blocks (nine per page) which represent the minimum and maximum color saturation, as well as limits for lightness, darkness, redness and yellowness compliances.

AA-4200 - \$59.99



**WOOSTER PAINTER'S
HAND MITT**

This lined glove is ideal for painting cellular communication towers, cell monopoles, angle steel, pipes, ornamental iron, hand railing, and more both quickly and efficiently. For use with all paints. Can also be used for cleaning, polishing, dusting.

R044 - \$4.99



**ANCHOR
STAINLESS STEEL
SHOE HANDLE
WIRE BRUSH**

Heavy-duty industrial brush, unsurpassed wire fill and length, designed to outwork and outlast so called "economy" brushes.

387SS - \$2.79



**3" WOOSTER CHIP
BRUSH, 12 PACK**

Chip brush head features white Chinese bristle; natural wood handle is lightweight for comfortable use; tin-plated steel ferrule; brush is disposable, and easy to use, sold in packs of 12.

1117 - \$9.79



**3M DISPOSABLE
PROTECTIVE
COVERALL**

Elastic waist, ankles, and wrists for convenience and freedom of movement. Two-way zipper with storm flap for convenience and to help provide additional protection. Available in sizes S-4XL.

4510 - \$6.99





KEELER & LONG ANODIC SELF-PRIMING COLD GALVANIZING PAINT

Rust inhibitive coating designed for corrosion protection in a single coat. Self-priming in many applications and will dry when applied in temperatures down to 35°F as long as the temperatures are expected to rise over the following months. Usable for painting weathered galvanized or previously painted surfaces of transmission or communication towers, poles, substation structures, chain link fencing, buildings, and bridges. Basic Data for Mixed Product at 77°F (25°C). Volume solids: 92% +/- 2%. VOC (Supplied): EPA Method 24: 0.5 lb/US gallon.

KL4404/02 2 Gallon - \$149.99

KL4404/05 5 Gallon - \$271.50



ZRC COLD GALVANIZING COMPOUND

95% zinc in the dry film using only Type III "ultra pure" ASTM-D-520 zinc. Meets and exceeds Fed. Spec. DOD-P-21035A, MIL-P-26915A, ASTM Des. A-780, and SSPC-Paint 20. This high purity zinc dust is compounded with a tenacious non-encapsulating binder. The result is a self-healing galvanic film that does not require sandblasting for most applications, providing both up-front labor savings and extended longevity of corrosion protection. Passes 3,000 hours salt spray testing. Passes Preece Test for hot-dip galvanizing. Passes 9-year subtropical testing. Low VOC approved in all 50 states. Battleship grey color with a flat finish.

10003 1 Gallon - \$158.99

10000 24 Pack aerosol - \$257.99

10002 Quart - \$45.99



ZRC GALVILITE GALVANIZING REPAIR COMPOUND

Shiny finish with 95% pure zinc in dry film. Low VOC. Withstands 3,000 hours salt spray testing. Designed specifically for field and shop repair of hot dip galvanizing. Silver finish closely blends with the color of new hot dip galvanizing. Meets or exceeds galvanizing repair specifications. Apply by brush, roller, or spray. Passes 9-year subtropical testing. Resists intermittent dry-heat temperatures of up to 750°F.

20013 1 Gallon - \$159.99

20012 Quart - \$45.99

20010 24 Pack aerosol - \$274.99



ZINGASOLV

Zingasolv is the recommended thinner to be used with Zinga for spray application. Can also be used for cleaning equipment. It's recommended to dilute by 0 to 5% for conventional spraying and 0 to 25% for airless spraying.

ZSOL1 1 Liter - \$18.00

ZSOL5 5 Liter - \$80.00



ZINGA ZINC FILM COLD GALVANIZING COATING

96% zinc in the dry film - the highest zinc purity in the world. Provides cathodic protection to steel. Dry to touch in 10 minutes.

Z10 1 Gallon - \$349.99

ZC 12 Pack aerosol - \$298.00

Z5 1/2 Gallon - \$183.00

Z1 12.5 Ounces - \$44.99



CROWN BRITE COLD GALVANIZING COMPOUND

Bright, glistening finish with 65% pure zinc in a dry film. Can be easily sprayed, brushed, or dipped onto any metal surface. Meets performance requirements of ASTM A-780-93A. Good film integrity after 336 hours of salt spray.

7008G 1 Gallon - \$124.99

7008VG 1 Gallon, low VOC - \$206.99

7008Q Quart - \$34.99

7008 12 Pack aerosol - \$96.99



CROWN COLD GALVANIZING COMPOUND

Light gray, matte finish with 93% pure zinc in a dry film. Can be easily sprayed, brushed, or dipped onto any metal surface. Meets performance requirements of MIL-P-46105(MR), MIL-P-21035B, and DOD-P-21035A. Withstands 2,000 hours of 5% salt spray testing. Outstanding weld-through primer.

7007G 1 Gallon - \$118.99

7007VG 1 Gallon, low VOC - \$189.99

7007Q Quart - \$34.99

7007 12 Pack aerosol - \$79.99



Firelce is a next generation suppression agent that acts as a force multiplier by greatly enhancing the capability of water. Firelce is a diverse product that can be used in a variety of applications to combat fire. Easy-to-clean suppressant gel designed to quickly and efficiently coat, cool, and contain heat-related events. Safe for use around pets and children; eco-friendly, non-toxic and non-corrosive.



FIRELCE SHIELD 2.5 GALLON UL CLASS A FIRE EXTINGUISHER

For Class-A fires only. The extinguisher comes unpressurized, filled with pre-mixed Firelce. Effective in reducing thermal heat up to 10,000°F.
FI-FE-UL - \$199.99



FIRELCE SHIELD 2.5 GALLON CANISTER

This 2.5 Gallon canister comes empty, and is compatible with a 2.5 gallon pre-mixed refill.
FI-SC-C - \$184.99



FIRELCE SHIELD 64 FL OZ ASSET PROTECTION CANISTER

This 64 fl oz canister comes empty, and is compatible with 64 fl oz pre-mixed refill.
FI-SC-2L - \$195.99



FIRELCE 20 OZ COOLING GEL SPRAY

Easy to use, single direction handled spray canister. The slim, lightweight design makes it ideal for storage anywhere. Cool and contains fire up to 5,000°F. Not intended to replace a required NFPA10 compliant extinguisher.
FI-CG-20 - \$31.99



NEW

FIRELCE COMMUNICATIONS TOWER PROTECTION SYSTEM

60 gallon capacity 110 V / 16 amp mounted mixing tank with 1.5 HP electric motor. Includes (2) pickup hoses. Reduces direct costs of damage caused by welding sparks, fire, and slag. System components: (8) 50' hoses, (1) marsh funnel and cup, (2) water filters, (1) Firelce Shield CTP nozzle gun, (1) Firelce Shield CTP spray nozzle, (2) brushes - clean out kit. Free training is required for safe and effective use of the system.

CALL OUR GEAR EXPERTS® FOR YOUR CUSTOM QUOTE TODAY



FI-SS-32



FI-SC-2LR



FI-CTP-25GR



FI-CTP-B

FIRELCE SHIELD CTP

Shield protection right where you need it, when you need it. Shield is well suited for use in plumbing, soldering, pipe fitting, automotive, welding and brazing. Simply refill the spent canister, pressurize in accordance with the manufacturer's instructions.

FI-SS-32 32 fl oz spray bottle - \$35.99

FI-SC-2LR 64 oz container - \$39.99

FI-CTP-25GR 2.5 gallon container - \$69.99

FI-CTP-B 5 lb bucket - \$159.99



FIRELCE XT 2.5 GALLON PRE-MIXED REFILL

Firelce XT is a fire fighting gel. It breaks the fire triangle by suffocating the oxygen from the fuel by cooling the heat source, thus breaking the thermal barriers of fire. A precisely measured 2.5 gallon allows the quick filling of a Firelce UL 2.5 gallon extinguisher. Firelce is effective up to 5,000° F and adheres to virtually any surface. Extensively tested and shown to be effective on metal fires (magnesium, titanium, calcium, potassium, and lithium), battery fires, tire fires, wildland fires, some accelerant fires, and voltages up to 50kV/40ka.

FI-FE-25GR - \$39.99



**BUCKEYE 5 ABV V/B
DRY CHEMICAL FIRE
EXTINGUISHER**

Aluminum valve. Type A Size II, Type B:C
Size I. Wall mounted. UL/ULC Rating:
3-A:40-B:C. Discharge range: 12'-18'.
16.375" H x 7.25" W, 4.25" DIA, 5 lbs.
25614 - \$42.99



**BUCKEYE 5 ABC
DRY CHEMICAL FIRE
EXTINGUISHER**

Aluminum valve. Type A Size II, Type B:C
Size I. Wall mounted. UL/ULC Rating:
3-A:40-B:C. Discharge range: 12'-18'.
16.375" H x 7.25" W, 4.25" DIA, 5 lbs.
10914 - \$40.99



**BUCKEYE 10 TALL
ABC DRY CHEMICAL
FIRE EXTINGUISHER**

Aluminum valve. Type A Size II, Type B:C
Size II. Wall mounted. UL/ULC Rating:
4-A:80-B:C. Discharge range: 15'-21'.
21" H x 7.75" W, 5.125" DIA, 10 lbs.
11340 - \$69.99



**BUCKEYE 20S ABC
DRY CHEMICAL FIRE
EXTINGUISHER**

Aluminum valve. Type A Size II, Type B:C
Size III. Wall mounted. UL/ULC Rating:
10-A:120-B:C. Discharge range: 15'-21'.
21.25" H x 8.75" W, 7.5" DIA, 20 lbs.
12120 - \$112.99



**BUCKEYE 2.5 ABC V/B
DRY CHEMICAL FIRE
EXTINGUISHER**

Aluminum valve. Type B:C Size I. Vehicle
mounted. UL/ULC Rating: 1-A:10-B:C.
Discharge range: 8'-15'. 17.75" H x
4.875" W, 3.375" DIA, 2.5 lbs.
13315 - \$35.99



BUCKEYE VEHICLE BRACKET

5 lbs, 4.25 inches diameter. Strong and durable
mounting hardware for portable fire extinguishers.
Whether you are looking for vehicle or mount on
a wall, you can be sure that all brackets and wall
hooks are designed to keep your fire extinguisher
secure and readily accessible.
700270 - \$12.99



**ACCUFORM
ADHESIVE VINYL FIRE
EXTINGUISHER SIGN**

Fire extinguisher signs identify the
location and sometimes the type of fire
extinguisher to aid with deployment in
case of emergency. 4" x 12".
MFXG543VS - \$5.86



**ACCUFORM ALUMINUM FIRE
EXTINGUISHER INSPECTION TAG**

3" x 2-1/4". 4-year inspection period. Allows you to
accurately record your fire extinguisher inspections.
Features 3/16" mounting hole, UV protective coating,
service temperature range: -40° to 250°F, and endures
outdoor environmental conditions.
TRS22018 5 Pack - \$12.99





MASTER RED ZENEX THERMOPLASTIC SAFETY PADLOCK

1-1/2" wide, 1-3/4" tall
Thermoplastic black body. Shackle with 1-1/2" clearance, Key retaining - ensures that padlock is not left unlocked.

410RED - \$14.50



MASTER LOCK GRIP TIGHT CIRCUIT BREAKER LOCKOUT

Fits wide or tall breaker toggles typically found on hi-voltage/hi-ampereage breakers. Great strength with universal fit.

491B - \$8.19

493B Standard Toggle - \$6.98



MASTER LOCK 1" STEEL LOCKOUT HASP

Lockout by multiple workers at each lockout point, control cannot be turned on until last worker's safety padlock is removed from hasp. Heavy gauge steel jaw with red vinyl coated handle. 1-3/4" x 4-1/2" with 1" inside jaw diameter. Holds up to (6) safety padlocks.

420 - \$5.19



ACCUFORM GROUP LOCKOUT JOB TAGS

5 pack of nearly indestructible laminate lockout job tags. Sealed by thick laminate on both sides. Tear-proof, weather proof, chemical-resistant. 3/8" hole with reinforced pull-proof metal grommet. 5-3/4" x 3-1/4".

MDT251LTM 5 Pack - \$12.49

MDT251LTP 25 Pack - \$54.99



MASTER LOCK ZENEX 10 LOCK PADLOCK STATION

Covered padlock station with (10) of the 410RED Zenex padlocks, keyed differently, (2) 420 hasps and (2) bags (12/pack) of 497A Danger Do Not Operate lockout tags, lockable translucent cover. 15-1/2" high, 22" wide, 1-3/4" deep.

1483BP410 - \$269.99



STOPOUT CINCH CABLE LOCKOUT

Lockout contains internal cable spooling feature to quickly, simply and neatly extend and loop the 6'. Nylon-coated, steel cable through several devices to lock them out. Insert the cable end back into cinch lock device for it to "cinch" tight and unmovable.

KDD630 - \$35.99



STOPOUT DISPOSABLE PADLOCK SEAL

Cost-saving, single-use lock device for operation-wide plant and facility lockout shutdown and turnaround. Eliminates the hassle of misplaced locks and keys. Band can only be broken or cut for removal. 10-pack.

TLS202 - \$26.99



EQUIPMENT STATUS TAGS

Identify clearly and alert staff to cautions with durable safety tags that work effectively in extreme environments. Available in three materials (5 pack or 25 pack).

TRS307 - Starting at \$6.99



MASTER LOCK ELECTRICAL LOCKOUT TAGOUT KIT

(3) Zenex padlocks, keyed alike, (1) circuit breaker padlock, (1) lockout hasp, (1) labeled snap-on red lockout hasp, (2) Grip Tight circuit breaker lockout devices for tall or wide sizes, (3) Grip Tight circuit breaker lockout devices for standard single and double sizes, (1) universal wall switch lockout device, and (1) Bag (12/Pack) of lockout tags.

1457E410KA - \$151.99





FE7220



FE3224



FS1510



FMP1510

LOUISVILLE EXTENSION LADDER

Non-conductive fiberglass extension ladder carries up to 300 lbs. Features fully serrated D-shaped rungs for a slip resistant surface, non-marring rail end caps, full metal boot, and aluminum plate connection rungs.

FE7220 20' - \$324.99

LOUISVILLE EXTENSION LADDER

Extra heavy-duty extension ladder can hold up to 300 lbs and made from non-conductive fiberglass. Comes equipped with outside slide guides, D-shape rungs, non-marring rail end caps, QuickLatch rung lock, and swivel safety shoes.

FE3216 16' - \$195.99

FE3220 20' - \$209.99

FE3224 24' - \$249.99

FE3228 28' - \$322.99

FE3232 32' - \$399.99

LOUISVILLE STEP LADDER

Extra heavy-duty, the step ladder can hold up to 300 lbs and made from non-conductive fiberglass. Comes equipped with slip resistant footing, a molded top with hardware tray, paint can holder, handyman's tool slots, pipe holder, and a magnet to secure small steel parts.

FS1506 6' - \$102.99

FS1508 8' - \$134.99

FS1510 10' - \$198.99

LOUISVILLE TWIN PLATFORM LADDER

This fiberglass twin platform step ladder has a 300 lbs load capacity. Rated ANSI Type IA. Features a slim, gapless slip-resistant platform with a top rail guard. Can be used from both sides simultaneously. Equipped with a heavy duty gauge steel hinge, non-marring bonded tread mechanically fastened to the upper boot to create a secure slip-resistant footing, and double-rivet step construction. Meets or exceeds the safety standards set by ANSI, CSA, and OSHA.

FMP1504 4' - \$352.99

FMP1506 6' - \$411.99

FMP1508 8' - \$536.99

FMP1510 10' - \$683.99



LADDER STEP GUARD SAFETY SIGN

11" X 14" sign made from 3 mm PVC acrylic with a laminated cover for durability, English and Spanish safety notices, mounting holes can be custom drilled by end user to fit every ladder, easily attach sign using zip ties, sign can be trimmed for smaller ladders.

2801 1 Sign - \$14.99

2802 10 Signs - \$129.99

GUARDIAN SAFE-T LADDER EXTENSION

Designed to attach over the top of the ladder and provide a safe and easy transition from the ladder to a second surface, requires no tools.

10800 - \$169.99



OSHA LADDER LABEL KIT

Includes all necessary warning, caution, danger, and instruction labels; replaces worn out or destroyed labels.

PK708-EL Extension ladder - \$7.00

PK708-SL Step ladder - \$7.00



LADDER LOCK

Helps prevent accidents and property damage, easy to use, constructed of steel with a strong spring for holding power, clamps onto gutters, metal roofs, piping, plywood and much more.

LADDERLOCK - \$36.95





MILWAUKEE M18 ROCKED LED TOWER LIGHT

Rotating and pivoting head extends from 4'-7'. Compact 26" footprint with low center of gravity. 2,000 lms. (3) optimal output modes for optimal brightness and runtime. Low battery indicator alerts users when battery is nearing end of charge. Impact resistant. Reinforced legs.

2130-20 - \$249.99



SOUTHWIRE 1,000 WATT TWIN HEAD WORK LIGHT

16,000 lms. Twin head lamps rotate 360-degrees. Fixture telescopes up to 42" tall. 4' 18/3-gauge cord and cord storage bracket. All metal construction with hinged face. UV protected tempered safety glass. One weatherproof power switch per lamp for individual control.

L13SW - \$49.99



CSA COMPLIANT

GENERAC GP SERIES 1800 PORTABLE GENERATOR

Generac's OHV engine. Large-capacity steel fuel tank. Low-oil level shutdown. Hardened steel tube cradle. Fold-down handle. CSA certified. 1,800 watt.

5981 - \$359.00



CSA COMPLIANT

GENERAC GP SERIES 6500 PORTABLE GENERATOR

Generac's OHV engine. Large-capacity steel fuel tank. Low-oil level shutdown. Hardened steel tube cradle. Fold-down handle. Never-flat wheels. CSA and CARB certified. 6,500 watt.

5940 - \$799.00

5941 Electric start - \$899.00



CSA COMPLIANT

GENERAC XC SERIES 8000 PORTABLE GENERATOR

Generac's G-Force engine. Large-capacity fuel tank. Full panel GFCI protection. Hardened steel tube cradle. Fold-down handle. Never-flat wheels. CSA certified and OSHA compliant. 8,000 watt.

6226 Electric start - \$2,199.99



QUICK SHIP

SOUTHWIRE IN-LINE GFCI TRI-SOURCE

2' length, 120 V rating, 15 amp, rainproof, SJTW-A wire type. Reset and manual test buttons. NEMA 5-15 to NEMA 5-15R. -35°C to +66°C temperature range.

26020008-6 - \$24.96

VIDEO H2O FR



SOLID GROUND 50' INLINE GFCI EXTENSION CORD

SJT00W PVC jacket to offer outdoor, oil, water, and flame resistance. 15 amp GFCI integrated in the cord. Anchored solid ground pin that does not detach from the plug. The ground light indicator shows that the outlet and cord are grounded for your safety. Meets NEC's FT2 Flame Resistance Standard. 125 volt. -29°F to +220°F temperature range.

1050GFCI - \$195.00



SOUTHWIRE EXTENSION CORDS

Southwire Extension power cords have a specially formulated SJTW vinyl outer jacket that won't crack or break. Southwire has tested these cords to temperatures as low as -35 degrees Fahrenheit. -40°C to +60°C temperature range.

PART	GA/COND	LENGTH	125 V RATING	PRICE
2587SW8802	12/3	25'	15A	\$24.99
2588SW0002	12/3	50'	15A	\$49.99
2589SW0002	12/3	100'	15A	\$69.99
2688SW8802	10/3	50'	15A	\$99.99
2689SW8802	10/3	100'	15A	\$129.99

VIDEO H2O FR



SOLID GROUND CORD

Features anchored solid copper ground pin that does not detach from the plug. Grounded safety light indicator and polarity indicated. Reinforced jacket retention technology with 360 degree bite. SJT00W outdoor oil resistant and water resistant jacket. Meets NEC's FT2 Flame Resistance Standard. 12/3 gauge delivers 15 amps of power. -29°F to +220°F temperature range.

PART	GA/COND	LENGTH	125 V RATING	PRICE
1010	12/3	10'	15A	\$44.99
1025	12/3	25'	15A	\$69.99
1050	12/3	50'	15A	\$94.99
1100G	12/3	100'	15A	\$149.99





MILWAUKEE M18 JOBSITE RADIO

7.70" length x 15.80" width x 7.75" height; 10.34 lbs; high performance audio system with dual speakers and passive radiators delivers loud, clear sound with deep accurate bass; durable design protects from drops and other harmful job site conditions and features a weather sealed auxiliary compartment; digital AM/FM tuner with 10 station presets; USB charger for electronic devices; powered by all M18 batteries or AC outlet (battery not included); up to 12 hours run time with M18 battery.

2890-20 - \$119.00



MILWAUKEE M18 WET / DRY VACUUM

Works on all Milwaukee 18 V slide-on RedLithium or NiCd batteries, powerful motor to provide strong suction and air flow, tool box style for easy transport and storage, on-board accessory and hose storage, HEPA filter, and built-in blower port, ideal for both wet and dry applications. Battery not included.

0880-20 - \$99.00



MILWAUKEE 6 PIECE SCREWDRIVER SET

Includes 3" cabinet 3/16" screwdriver, 3" Phillips #1 screwdriver, 4" Phillips #2 screwdriver, 4" slotted 1/4" steel cap screwdriver, 6" cabinet 3/16" screwdriver, 6" slotted 5/16" steel cap screwdriver.

48-22-2006 - \$34.99



MILWAUKEE 10 IN 1 ECX RATCHETING MULTI BIT DRIVER

Features 3-1/2" power groove chrome plated bits for power tool compatibility. Revolver style bit storage. 10 gauge wire stripper; Magnetic bit retention.

48-22-2301 - \$21.99



MILWAUKEE FASTBACK SPRING ASSISTED KNIFE

Spring-assisted opening for one-handed operation, black oxide-coated stainless steel serrated blade to cut through tough materials, secures the blade in the open position with liner lock, small and compact to store easily yet withstands job site abuse, reversible wire-form belt clip.

48-22-1995 - \$24.00



MILWAUKEE FASTBACK FLIP UTILITY KNIFE

Features magnetic blade storage, press-and-flip operation for one-handed opening, tool-free blade change, durable all-metal body, gut hook, wire stripper, and wire-form belt clip. Includes Fastback II flip utility knife with storage, (2) utility knife blades.

48-22-1903 With storage - \$14.99

48-22-1901 Without storage - \$12.99

MILWAUKEE INKZALL BLACK FINE POINT MARKER

Inkzall markers feature clog resistant tips and the ability to write through dusty, rough, wet or oily surfaces. Ink dries quickly to reduce smearing markings, without drying out quickly when the cap is left off. Built-in hard hat clip for easy storage and access.

48-22-3104 4 Markers - \$4.60

48-22-3100 1 Marker - \$1.25





MILWAUKEE SAWZALL M18 FUEL RECIP SAW KIT

Includes Fuel Sawzall recip saw, (1) M18 RedLithium XC5.0 extended capacity battery pack, M18 & M12 multi-voltage charger, blade, and carrying case.

2720-21 - \$299.00



MILWAUKEE 9-PIECE SHOCKWAVE 1/2" DRIVE THIN WALL DEEP IMPACT SOCKET SET

Chromoly steel and custom heat treatment for maximum durability, drives on flats to reduce stripping and breakage, thin wall construction for impact strength in tight clearance applications; Shockwave impact sockets included: 3/8", 7/16", 1/2", 9/16", 5/8", 11/16", 3/4", 7/8"; also includes 1/4" hex to 1/2" square adapter.

49-66-4484 - \$75.49



MILWAUKEE M18 FUEL 4-1/2" / 5" GRINDER PADDLE SWITCH NO-LOCK KIT

Cordless grinder with corded performance. Supplies maximum sustained power to complete the toughest grinding, surface preparation and cutting applications. Uses M18 RedLithium XC5.0 extended battery pack. M18 and M12 Multi-Voltage Charger. The grinder features Redlink Plus Intelligence. 18 V, 8,500 RPM speed.

2780-22 - \$399.99



MILWAUKEE SHOCKWAVE 1/4" HEX TO 3/8" SQUARE SOCKET ADAPTER

Proprietary steel and heat treat process for maximum strength and durability, and heavy duty construction for fastening capabilities in all impacts.

48-32-5031 - \$4.99



MILWAUKEE SHOCKWAVE 1/4" HEX TO 1/2" SQUARE SOCKET ADAPTER

Proprietary steel and heat treat process for maximum strength and durability, and heavy duty construction for fastening capabilities in all impacts.

48-32-5032 - \$6.79



MILWAUKEE 9" 18 TPI "THE TORCH" SAWZALL BLADES (5 PACK)

Grid Iron honeycomb pattern increases blade rigidity to resist blade buckling. Tough neck ribs strengthen the blade tang and minimize breakage.

48-00-5788 9" - \$19.99

48-00-5784 6" - \$14.99



MILWAUKEE M18 REDLITHIUM XC5.0 EXTENDED CAPACITY BATTERY 2 PACK

Long lasting performance and durability. All-weather performance. Fuel gauge onboard. Powers more than 60 Milwaukee M18 cordless power tools.

48-11-1852 - \$199.00



MILWAUKEE M18 FUEL 1/4" HEX IMPACT DRIVER KIT

Powerstate brushless motor to drive screws faster. Redlink Plus prevents overloading or overheating. RedLithium XC5.0 Batteries. 4-mode drive control provides control over output speed and power. 18 V.

2753-22 - \$556.00



MILWAUKEE CUT-OFF WHEEL

4-1/2" x .045" x 7/8". Comprehensive offering for general purpose to specialized high performance applications. Consistent performance from wheel to wheel through superior manufacturing processes. Tested for balance, resulting in smooth, vibration free grinding and cutting.

49-94-4505 - \$2.49



MILWAUKEE DUAL TEMPERATURE HEAT GUN

1.8 lb heat gun offers 570 degree and 1,000 degree temperature ranges. Stay cool handles and heat shields. Unique impact resistant heating element. Three position rocker switch - off, high and low.

8975-6 - \$99.99





MILWAUKEE FUEL LITHIUM-ION 2-TOOL COMBO KIT

Includes M18 Fuel 1/2" hammer drill / driver, M18 Fuel 1/4" hex impact driver, (2) M18 RedLithium XC 5.0 extended capacity battery packs, M18 & M12 multi-voltage charger, belt clip, carrying case, side handle. M18 Fuel features a power state brushless motor, Redlink Plus electronic intelligence and RedLithium battery technology, this results in longer motor life, more run time and more power. The power state brushless motor works harder and lives longer than all leading competitors, while reducing noise and cooling more rapidly.

2897-22 - \$399.00

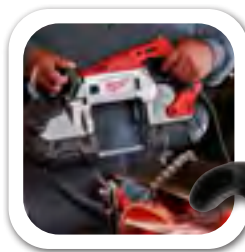

MILWAUKEE DEEP CUT VARIABLE SPEED BAND SAW KIT

The new Deep Cut Band Saws deliver 2X more durability, best-in-class power at 11 Amps, revolutionary cut visibility and the industry's largest cut capacity at 5" by 5". Job site armor technology is made from composite material and crush zone barriers provide long lasting rugged protection. LED light illuminates surface for increased accuracy and productivity. 14.5 lbs, includes deep cut variable speed band saw and carrying case.

6232-21 - \$299.00



MILWAUKEE M18 CORDLESS LITHIUM-ION 6-TOOL COMBO KIT

Includes M18 cordless lithium-ion 1/2" hammer drill/driver, Sawzall M18 cordless Lithium-ion recip saw, M18 cordless Lithium-ion 6-1/2" circular saw, M18 1/4" hex compact impact driver, M18 cordless Lithium-ion 4-1/2" cut-off / grinder, (2) M18 XC high capacity RedLithium batteries, M18 & M12 multi-voltage charger, M18 work light, contractor bag. Also available with Fuel option with Part # 2796-26.

2696-26 - \$649.00

2696-24 4-piece kit includes M18 cordless lithium-ion 1/2" hammer drill/driver, Sawzall M18 cordless Lithium-ion recip saw, M18 1/4" hex compact impact driver, batteries, charger, M18 work light, contractor bag - \$429.00

MILWAUKEE M18 FUEL DEEP CUT BAND SAW KIT

Includes M18 Fuel deep cut band saw kit, (2) M18 RedLithium XC 5.0 extended capacity battery pack, M18 & M12 multi-voltage charger, blade, and carrying case.

2729-22 2 batteries - \$579.00

2729-21 1 battery - \$479.00



MILWAUKEE M18 LITHIUM-ION 2-TOOL COMBO KIT

Includes M18 cordless lithium-ion 1/2" hammer drill/driver, M18 1/4" hex compact impact driver, (2) M18 RedLithium XC extended capacity batteries, M18 & M12 multi-voltage charger, and contractor bag.

2697-22 - \$299.00



MILWAUKEE 18 PIECE SHOCKWAVE DRILL BIT SET

Includes (1) Phillips Bit 1" P1, (1) Phillips Bit 1" P2, (1) Phillips Bit 1" P3, (1) Slotted Bit 1" SL 1/4", (1) Slotted Bit 1" SL 3/16", (1) Square Bit 1" SQ1, (1) Square Bit 1" SQ2, (2) Phillips Bit 2" P2, (1) Phillips Bit 2" P3, (2) Square Bit 2" SQ2, (1) Square Bit 2" SQ3, (1) TORX 2" T15 (1) TORX Bit 2" T20, (1) 3 1/2" Phillips #2, (1) 3 1/2" Square Drive #2, (1) Case with Bulk Storage Container, (1) Shockwave Magnetic Bit Holder.

48-32-4403 - \$20.29



MILWAUKEE THUNDERBOLT BLACK OXIDE DRILL BIT SET

Includes corrosion resistant black oxide coating 1/16", 11/64", 13/64", 1/4", 1/8", 3/16", 3/32", 3/8", 5/16", 5/32", 5/64", 7/32", 7/64", 9/32", 9/64" drill bits and compact bit holder.

48-89-2803 - \$31.99





QUICK SHIP

BOSCH 18V 1-1/8" RECIPROCATING SAW KIT

The Bosch CRS180-B14 18 V 1-1/8 inch reciprocating saw kit comes with a powerful, compact saw and a CORE18V battery. The CORE18V battery features next-gen Li-Ion technology that produces 80% more power than previous cells. Weighs 6.35 lbs.

CRS180-B14 - \$319.99



QUICK SHIP

BOSCH 7-1/4" WORM DRIVE SAW

The Bosch 7-1/4 Inch Worm Drive Saw system features an enormous gearing ratio in a compact size for tremendous power in a manageable package. This saw model features sturdy magnesium housing and a die-cast magnesium footplate for true strength and a lifetime of reliable use.

CSW41 - \$219.99



NEW

BOSCH 12V MAX LED WORKLIGHT

The Bosch FL12B 12 V Max worklight provides the brightest worklight in its class, with 10 highly intense LED lights. It's ideal for professionals who are in need of hands-free lighting.

FL12 - \$59.99



QUICK SHIP

BOSCH 165 FT. LASER MEASURE

The Bosch 165 Foot Laser Measure features an upgraded backlit color display and Bluetooth technology that is compatible with the free MeasureOn app.

GLM50C - \$149.99



QUICK SHIP

NEW

VIDEO

BOSCH BLAZE OUTDOOR 400 FT. CONNECTED LITHIUM-ION LASER MEASURE WITH CAMERA

The Bosch Blaze Outdoor Connected Laser Measure with Camera is the latest in laser measure technology. It features an adjustable zoom camera to find the laser spot in bright conditions, measuring up to 400 Ft. and can transfer the measurement documentation to a smartphone or tablet with Bluetooth using Bosch's MeasureOn app. The outdoor laser measuring device provides real-time length, length, area, volume, and indirect measuring functions – which are simple to take advantage of thanks to the display guide walking through each measurement process. You can see the last 50 measurements on the tool and store up to 600 images for later use.

GLM400CL - \$299.99



QUICK SHIP

BOSCH 5" CONCRETE SURFACE GRINDER W/ DUST COLLECTION SHROUD

The Bosch 5 Inch Concrete Surface Grinder has a dedicated dust-collection shroud for a cleaner, safer work environment. It delivers 12.5 AMPS and up to 9,300 RPM, for concrete grading, surface preparation. Weighs 5.95 lbs.

CSG15 - \$398.99



QUICK SHIP

NEW

BOSCH 1" SDS-PLUS BULLDOG XTREME ROTARY HAMMER

The Bosch 1" SDS-plus Bulldog Xtreme Rotary Hammer features a powerful 7.5 amp motor and a multi-function selector. Easily use the selector to match the mode to your task with drilling only or hammer drilling and chiseling options. Weighs 6.7 lbs.

11255VSR - \$199.99





BOSCH 14-GALLON DUST EXTRACTOR WITH AUTOMATIC FILTER CLEAN

The Bosch VAC series dust extractors come with the best in class combination of air flow and suction power. Capable of wet and dry pick up. When paired with a HEPA filter, this unit has been independently tested to meet the EPA definition of a HEPA vacuum. The automatic filter cleaning system cleans the filter every 15 seconds, ensuring the dust extractor is always working at maximum efficiency. Power tool activation reduces the need for a second extension cord, the tool can be plugged directly into the dust extractor. Heavy duty wheels, a locking castor, a metal frame, and L-BOXX compatibility. Includes 9.85' vacuum hose, bend nozzle, power tool adapter nozzle, cellulose flat filter, and a plastic bag.

VAC140A - \$668.99



BOSCH SDS-MAX & SPLINE DUST-COLLECTION ATTACHMENT

Fits Bosch SDS-max and spline combination rotary and demolition hammers. Allows the user to access the chisel for installation, removal and adjustment without removing the attachment. Includes chiseling dust collection attachment, 3-piece adaptor, and extension tube.

HDC300 - \$118.99



BOSCH UNIVERSAL DUST COLLECTION ATTACHMENT

Flexible dust collection attachment for SDS-plus and SDS-max hammers for drilling into concrete. Optimized for drilling diameters from 5/8" - 1-3/8", but can accommodate up to 2-1/2" if the brush ring is removed. Attachment features two unique air chambers.

HDC200 - \$58.99



BOSCH SURFACE GRINDING DUST-EXTRACTION ATTACHMENT

Surface grinding dust-extraction attachment for Bosch 4-1/2" and 5" angle grinders. Features flexible guard design, removable nose piece, and replaceable brush ring.

18SG-5E - \$58.99



BOSCH ANTI-STATIC DUST EXTRACTION HOSE

Anti-static hose for Bosch VAC090 and VAC140 dust extractors. Includes 16.4' 22 mm anti-static flexible hose and adapter for connection to power tool.

VH1622A - \$118.99

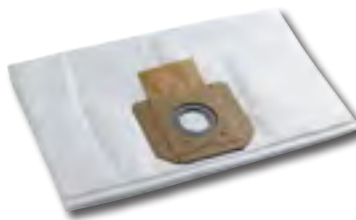

BOSCH FLEECE DUST BAG

Replacement fleece filter bag for VAC series dust extractors. Each filter bag comes with a port cover which securely closes opening of the filter bag and keeps the dust and debris inside during the disposal process.

VB090F 9-gallon, 5-pack - \$33.99

VB140F 14-gallon, 5 pack - \$53.99



BOSCH PLEATED HEPA FILTER

Pairs with the either the VAC090A or VAC140A dust extractor with auto filter cleaning. Captures 99.97% of particles 0.3 microns and larger. Can be used for EPA lead-related Renovations Repair and Painting (RRP) rule compliant applications. Use in dry applications only.

VF120H - \$108.99

BOSCH 1-5/8" SDS-MAX COMBINATION HAMMER

Features a powerful 13.0-amp motor and has a dual-mode selector for combination versatility. Hammer has integral clutch that helps minimize torque reaction. Includes 360° auxiliary side handle and carrying case. Weighs 15.2 lbs.

11264EVS - \$598.99



BOSCH 4-1/2" ANGLE GRINDER

10 amps and 11,500 rpm. Has directed air flow that diverts dust away from vital components, and has direct-motor cooling, giving it higher overload capabilities. Includes backing flange, lock nut, spanner wrench, grinding guard, vibration control side handle.

GWS10-45 - \$88.99





GO TO WWW.GMESUPPLY.COM/TOOLS
TO VIEW ENTIRE TOOLS SELECTION ONLINE



HMD904 SPECIFICATIONS
Electrical System: 115 V, 50/60 Hz - 9 A, 1035 W 230 V, 50/60 Hz - 4.5 A, 1035 W
Motor: 8 A (115 V), 4 A (230 V) 450 RPM
Diameter: 7/16" - 1-1/2" (12 mm - 38 mm)
Depth: 2" (50 mm)
Cutter/Mount: Rotabroach, Copperhead & Fusion cutters, 3/4" (19 mm) shank
Dimensions: 7-13/16" H x 6-1/2" W x 11-11/16" L



HMD130 SPECIFICATIONS
Electrical System: 115 V, 50/60 Hz - 9 A, 1035 W 230 V, 50/60 Hz - 4.5 A, 1035 W
Motor: 8 A (120 V), 4 A (240 V) 450 RPM
Diameter: 1/2"-1-3/8" (12 mm - 35 mm)
Depth: 1" (25 mm)
Cutter/Mount: RotaLoc with push and turn style shank
Dimensions: 6-11/16" H x 6-3/4" W x 14-11/16" L

HOUGEN VERSATILE PORTABLE MAGNETIC DRILL

Large 1-1/2" x 2" capacity, positive slug ejection, more durable and powerful magnet, many accessories are available for a portable machine shop including: drill chucks, tapping, countersink, and more; feed handles quickly change from side to side, lift detector safety system, gravity fed coolant system, carrying case included, one year warranty, precisely line up your pilot with the holes center location, one stroke lock and unlock handle, great for horizontal, overhead, tight areas, and getting out over another piece of steel.

HMD904 - \$845.00
HMD904S With swivel base - \$1,125.00

HOUGEN LOW PROFILE RIGHT ANGLE DRILL

Lightweight at only 23.8 lbs, patented quill feed arbor for smooth cuts and minimal maintenance, uses RotaLoc Plus annular cutters which requires no tools for installation or removal, positive slug ejection, high torque gearing, lift detector safety system, feed handle switches easily from side to side, ratchet can be used in place of feed handle, rear mounted controls, carrying handle, carrying case included, one year warranty.

HMD130 Ultra low profile (6-11/16" height, 23.8 lbs) - \$837.00



HOUGEN ROTAMAGIC SUPER CONCENTRATED CUTTING FLUID

Water soluble, biodegrade cutting lubricant that yields a 10:1 ratio when mixed with water; extends tool life and improves cutter performance.

11741 1 Pint bottle - \$3.25
11742 1 Gallon bottle - \$47.25



HOUGEN 1" ROTALOC PLUS ANNULAR CUTTERS (FOR HMD130)

1" depth of cut; more sizes available; use with pilot 17470.

17802 RotaLoc Plus Kit including 1/2", 5/8", 3/4" diameter plus (3) pilots and case - \$126.99

17218 9/16" / .5625" - \$36.50
17222 11/16" / .6875" - \$39.75
17226 13/16" / .8125" - \$44.80



HOUGEN 2" 12,000 SERIES ANNULAR CUTTERS (FOR HMD904)

2" depth of cut; copperhead carbide tips and more sizes available.

12214 7/16" / .4375" - \$36.19
12216 1/2" / .5000" - \$39.85
12218 9/16" / .5625" - \$45.19
12220 5/8" / .6250" - \$48.75
12222 11/16" / .6875" - \$54.05
12224 3/4" / .7500" - \$59.39
12226 13/16" / .8125" - \$62.95
12228 7/8" / .8750" - \$66.75



HOUGEN D.O.C. PILOT BITS

For 12,000 series annular cutters.

10532 2" D.O.C. for use with 7/16" - 9/16" - \$6.89

10528 2" D.O.C. for use with 5/8" and above - \$7.95

For RotaLoc Plus annular cutters

17470 1" D.O.C. for use with 7/16" and above - \$5.95



HOUGEN SLICK STICK LUBE

Softer than other stick lubricants for easy application, superior adhesion to the tool assuring thorough coverage.

11745 - \$10.59





ANCHOR BOLT CUTTER

Has a compound action blade made from hardened and tempered forged alloy steel. 18" length, straight cutting direction. Center cut type. Forged alloy steel jaw material. 5/16" cutting gap.
39-018 - \$18.99

KLEIN TOOLS HIGH LEVERAGE CABLE CUTTER

High-leverage design for exceptional cutting capability of 4/0 aluminum, 2/0 soft copper, 100-pair 24 AWG communications cable. Precision, one-hand shearing action. Made in USA.
63050 - \$32.99



CRESCENT TOOLS 2-PIECE ADJUSTABLE WRENCH SET

Includes an 8" and 12" adjustable wrench. Each wrench has a hex jaw design with an extra wide grip for comfort. Made of alloy steel and topped off with a chrome finish, opening sizes of 1-1/8" and 1-1/2", laser etched scale, wider knurl, handle is 70% and jaws open 25% wider than conventional wrenches.
AC2812VS - \$45.99



CRESCENT TOOLS 5-PIECE LOCKING JAW PLIER SET

Crescent locking pliers are made to a standard that results in long-term performance and durability; this set includes (3) curved jaw locking pliers (5", 7", and 10"), and (2) long nose locking pliers (6" and 9"); each plier features a patented angled tooth pattern for a better grip and an integrated wire cutter, nickel plated to resist rust and corrosion, non-slip locking grip.
CLP5SET - \$34.99



IRWIN INDUSTRIAL TOOLS 30-PIECE FASTENER DRIVE TOOL SET

Includes most popular insert bits, double ended bits, and nut setters. (4) magnetic nut setters in most popular sizes, (21) contractor grade insert bits and (4) double-end power bits, powerful magnetic bit case with rubberized grip and sliding latch.
357030 - \$24.99

IRWIN VISE-GRIP CURVED JAW LOCKING PLIERS

3-3/8" H, 11-3/4" L, 4.8" W, 1-7/8" jaw opening. Self-energizing lower jaw provides more gripping power with no slipping or stripping. Heavy input pressure jaw mechanism naturally grips tighter as more torque is applied. Classic trigger release provides maximum locking force. Made from high-grade heat-treated alloy steel for maximum toughness and durability.
4935576 - \$12.99



WISS HI-VIS MULTIMASTER LONG CUT AVIATION SNIPS

Blade design for straight cuts, non-slip grips, great for making long, fast cuts in several types of material including paper, plastic, sheet metal, aluminum, vinyl siding, screening, and much more; hi-visibility, non-slip, rubber grips on handle and serrated jaws, 10-1/2" long with 3" cut, twice as long as standard snips.
M300 - \$18.99



RIDGID 12" PROHACK HACK SAW

Superior strength and maximum control in a lightweight professional hack saw, casting provides both greater strength and improved access, blade replacement is easy with the large tensioning knob and the rubberized hand grips fore and aft ensure a controlled and speedy cut, provides (2) positions for mounting the blade: 45 or 90 degree.
20238 - \$22.99



KLEIN TOOLS RATCHETING CABLE CUTTER

High leverage ratchet mechanism for single-handed cutting of copper and aluminum cables, leaving no burrs or sharp edges. Patented two-step ratchet mechanism requires fewer strokes per cut. Quick release opens blades easily. Hardened steel cutting blades for lasting strength and sharpness. Locking lever keeps handles closed for easy transport. Maximum cable capacity 2-1/16".
63750 - \$364.99





KLEIN TOOLS BARREL-TYPE DRIFT PIN

Machined from quality alloy steel, tapers are uniform and blend into body diameter, 8" length, 13/16" max diameter.

- 3261 13/16" Max DIA - \$7.99**
- 3262 15/16" Max DIA - \$8.99**



KLEIN TOOLS STANDARD BULL PIN

Machined from quality alloy steel. Heat-treated for strength.

- 3252 1-3/16" Top DIA, 15" length - \$20.99**
- 3259 1-5/16" Top DIA, 12" length with tether - \$34.99**
- 3259TT 1-5/16" Top DIA, 12" length with tether - \$34.99**
- 3259TTS 1-5/16" Top DIA, 12" length, stainless steel with tether hole - \$98.99**



KLEIN TOOLS SLIM REBAR WORK PLIERS

9" length. Twists and cuts soft annealed rebar tie wire. Includes split ring for tethering when working at height. Spring loaded action for self opening. Induction hardened cutting knives. Heavy duty knurled jaws. Unique handle tempering helps absorb the "snap" when cutting wire. Hook bend handle.

- D201-7CSTT With tether ring - \$69.99**
- D201-7CST Without tether ring - \$40.99**



KLEIN TOOLS DIAGONAL CUTTING PLIERS FOR REBAR WORK

9" length. Includes split ring for tethering plier while working at height. High leverage design for greater cutting and gripping power. Induction hardened cutting knives.

- D248-9STT With tether ring - \$49.99**
- D248-9ST Without tether ring - \$39.99**



KLEIN TOOLS PUMP PLIERS

Quick-adjust rivet allows one-handed fast, easy adjustment. Includes split ring for tethering plier while working at height. 7/8" maximum parallel jaw opening for a range of applications. Smoothly adjusts between five machined tongue and groove jaw positions. Robust teeth for sure gripping action. Induction hardened jaws.

- D502-6TT 6-1/2" length - \$36.99**
- D502-10TT 10" length - \$43.99**
- D502-12TT 12" length - \$50.99**



QUICK SHIP

KLEIN TOOLS 14 PIECE PROFESSIONAL APPRENTICE TOOL SET

Includes an assortment of premium Klein Tools tailored to meet the needs and preferences of electrical apprentices. (4) pliers, (1) stripper / cutter, (2) nut drivers, (6) screwdrivers, (1) 12-pocket tool pouch, (1) web tool belt.

92914 - \$282.66

MADE IN USA



KLEIN TOOLS BULL PIN HOLDER

Made of leather and riveted for long life. Designed to hold standard bull pins. Slotted belt connection. Fits belts up to 2" wide. 3-1/4" x 11".

5417 - \$14.99

MADE IN USA



KLEIN TOOLS BULL PIN HOLDER TUNNEL CONNECTION

Made of leather and riveted for long life. Designed to hold standard bull pins. Slotted belt connection. Fits belts up to 3-1/2" wide. 3-1/4" x 12-1/4".

5417T - \$16.99



KLEIN TOOLS

KLEIN ERECTION WRENCH

Forged from select alloy steel to withstand high-leverage and heavy loads, extra-heavy duty head area gives maximum strength and durability, continuous taper of handle makes lining-up bolt holes easy and works on a range of bolt and/or hole sizes without binding, extra-large hub area works on larger diameter holes than other wrenches.

- 3219 1/2" Regular nut - \$35.99
- 3221 5/8" Regular nut - \$37.99
- 3222 3/4" Regular nut - \$42.99
- 3223 7/8" Regular nut - \$54.99
- 3224 1" Regular nut - \$60.99
- 3210 1/2" Heavy nut - \$35.99
- 3211 5/8" Heavy nut - \$37.99
- 3212 3/4" Heavy nut - \$42.99
- 3213 7/8" Heavy nut - \$54.99
- 3214 1" Heavy nut - \$60.99
- 3212TT 3/4" Heavy nut with tether hole - \$43.99
- 3213TT 7/8" Heavy nut with tether hole - \$52.99
- 3214TT 1" Heavy nut with tether hole - \$60.99



KLEIN TOOLS ADJUSTABLE SPUD WRENCH

Eliminates the need for carrying several fixed-size wrenches; tether hole for tool tether connection; corrosion resistant.

- 3239 16", Fits up to 1-1/2" - \$78.99
- 3227 10", Fits up to 1-5/16" - \$44.99

KLEIN TOOLS 1/2" DRIVE RATCHETING CONSTRUCTION WRENCH

Accepts 1/2" square-drive hex socket, reversible ratchet, industrial black finish for corrosion resistance.

- 3238 - \$83.99

KLEIN TOOLS CONNECTING BAR WITH TETHER HOLE

7/8" diameter, 36" length.

- 3246TT Round - \$71.99
- 3243 Hex - \$80.42

KLEIN TOOLS BROAD-HEAD BULL PIN

Forged, heat-treated bull pin increases efficiency by providing a larger striking surface. Long, even taper reduces binding and hang-up.

- 3255 1-1/4" Top DIA, 13-3/4" length - \$24.99
- 3256 1-1/16" Top DIA, 10" length - \$23.99
- 3255TT 1-1/4" Top DIA, 13-3/4" length with tether - \$29.99
- 3256TT 1-1/16" Top DIA, 10" length with tether - \$27.99

KLEIN TOOLS ERECTION WRENCH HOLDER

Leather construction for long life, tool-slots for two erection wrenches, holds Erection Wrenches and the Adjustable Head Construction Wrench (Cat. No. 3239).

- 5460 - \$17.99



KLEIN TOOLS ERECTION WRENCH HOLDER

Riveted leather construction for long life, slots for two erection wrenches, and holds erection wrenches and adjustable head construction wrench Cat. No. 3239.

- 5459T - \$19.49



KLEIN TOOLS CONNECTING BAR HOLDER WITH LOCK COLLAR

Made of leather, designed for use with Klein Tools 7/8" round connecting bars (Cat. Nos. 3248 and 3246), tunnel loop allows for weight distribution on belt, and fits belts up to 3-1/2" wide.

- 5459SLVR Bar holder - \$20.99
- 5459C Lock collar - \$8.49





**GEARWENCH
14-PIECE NON-
RATCHETING
WRENCH SET**

Metric kit includes sizes: 6 - 19 mm. SAE kit includes sizes: 1/4", 5/16", 11/32", 3/8", 7/16", 1/2", 9/16", 5/8", 11/16", 3/4", 13/16", 7/8", 15/16", and 1". Offset box end for increased access. Surface drive plus on open end for stronger grip and reduces fastener rounding.

81925 Metric - \$94.99

81924 SAE - \$84.99



STANLEY 16 OZ CURVED CLAW WOOD HANDLE HAMMER

Exclusive rim temper reduces incidences of chipping or spalling. Forged high-carbon steel head. Fully heat-treated and polished bell face.

51-616 - \$9.99



KLEIN TOOLS D507-6 ADJUSTABLE WRENCH EXTRA CAPACITY 6-1/2"

Extra capacity allows use of a smaller size wrench to handle bigger jobs, especially in confined spaces. Forged heat-treated alloy steel for maximum strength and light weight. Plastic-dipped handles for added comfort.

67525 - \$22.99



KLEIN TOOLS D506-4 4" ADJUSTABLE WRENCH PLASTIC DIPPED

Constructed of forged heat-treated alloy steel for maximum strength and light weight. Plastic-dipped handles for added comfort.

67501 - \$21.99



**CRESCENT
148 PIECE
PROFESSIONAL
TOOL SET**

This set contains all the tools needed for most industrial applications including a wide selection of standard and deep sockets in the most common SAE and metric sizes. All tools meet ANSI and ASME specifications. Industrial build quality.

CTK148MP - \$94.99



**KLEIN TOOLS
K7 7-PIECE NUT
DRIVER SET**

Set contains seven hollow-shaft nut drivers in the most popular hex sizes. Convenient vinyl pouch hangs up, rolls up. Handles are color-coded for easy identification. Hollow shafts facilitate work on stacked circuit boards or other long bolt applications. Meets or exceeds applicable ASME / ANSI specifications.

32608 - \$54.99



KLEIN TOOLS LLK12 L-STYLE HEX KEY CADDY SET 12-PIECE

Caddy has a unique locking feature and marked slots for each key. Heat-treated and tempered steel for added strength and durability. Rust and corrosion resistance. Extra length for hard-to-reach applications. Kit includes: LL2, LL4, LL5, LL6, LL7, LL8, LL9, LL10, LL12, LL14, LL16, LL20.

33221 - \$11.99



SCOTCH 35 VINYL COLOR CODING ELECTRICAL TAPE

7-mil thick polyvinyl chloride (PVC) color-coding tape, outstanding electrical and mechanical properties make this tape excellent for use in phase identification, color coding of motor leads and piping systems. Available in white, red, blue, green, yellow, orange, brown, gray, and violet; 66'.

35 - \$4.69



TEMFLEX GENERAL USE VINYL 1700 ELECTRICAL TAPE

Good quality, economical general purpose vinyl insulating tape; has excellent resistance to abrasion, moisture, alkalis, acid, copper corrosion and varying weather conditions. 60'.

1700 - \$0.99



SCOTCH SUPER 33+ VINYL ELECTRICAL TAPE

Quality, general-purpose vinyl insulating tape with excellent resistance to: abrasion, moisture, alkalis, acid, copper corrosion and varying weather conditions. 66'.

33+ - \$4.95



DEMAND THE SAFETY TO DO GREAT THINGS

DROPPED OBJECT INJURIES ARE ON THE RISE.
SO IS THE MOVEMENT TO PREVENT THEM.



**TENACITY
TO THE PEOPLE**

TAKE ACTION NOW

@ergo.zone/drops to get your
dropped objects prevention plan
off the ground today. Because an
injury to one is an injury to all.



SQUIDS® 3420
GLOVE CLIPS
SWIVELING DUAL CLIP MOUNT



SQUIDS® 3100F(1)
TOOL LANYARD
SINGLE CARABINER-10LBS



ARSENAL® 5517
TOPPED TOOL POUCH
SNAP-HINGE ZIPPER CLOSURE





10
LBS

SQUIDS TOOL TETHERING KIT 10 LBS

Kit includes (3) swiveling elastic loop tool tails, self-adhering tape requires no heat, tool tether single carabiner. Tether up to (3) 10 lb tools.

3182 - \$44.99



5
LBS

SQUIDS TOOL TETHERING KIT 5 LBS

Kit includes (3) detachable loops, 12' roll of self-adhering tape requires no heat, detachable single carabiner. Tether up to (4) 5 lb tools.

3181 - \$44.99



2
LBS

SQUIDS TOOL TETHERING KIT 2 LBS

Kit includes 4.5" web tool tails, self-adhering tape requires no heat, and coiled tether to design prevents snagging. Tether up to (6) 2 lb tools.

3180 - \$49.99



1
LB

SQUIDS RETRACTABLE TETHER

Tether locks into place at a desired length of up to 48" to secure your tools and prevent tangling; technora cord. Modular quick connect buckle. Stainless steel carabiners. Maximum capacity: 1 lb.

3000 Retractable tether - \$29.99

3001 Retractable tether elastic loop end - \$26.99

3025 3-Pack retractable accessory - \$21.65

3026 3-Pack retractable accessory elastic loops - \$9.99



15
LBS

SQUIDS ELASTIC LOOP TOOL TAILS

Retrofit attachment points, can also be used on belt or harness, pack of (3), 15 lb max, 11".

3703 - \$9.99

3703EXT 15 lb max, 18" - \$11.49

3713 10 lb max, 11" - \$12.49



15
LBS

SQUIDS HEAT TAPE TRAP

Holds up to 15 lbs. Securing a safe connection to tools like no other tool attachment tape. Quickly wraps on a variety of hand tools, power tools, and other equipment. Leaves no residue.

19760 12' Roll - \$16.99

19761 30' Roll - \$38.99



15
LBS

SQUIDS TOOL SHACKLE

Holds up to 15 lbs, 2 pack. Stainless steel shackles connect to tools with tapered mid sections or tools with captive holes, creating clean, secure attachment points for tethering.

3790S S - \$8.99

3790M M - \$9.99

3790L L - \$10.99

3790XL XL - \$12.99



6
LBS

SQUIDS POWER TOOL TRAP

Wraps around the battery portion of drills, impact drivers, and other cordless power tools, D-ring connection points attaches to a tether to prevent drops, two hook and loop straps secure trap to power tool battery, 1,000 D nylon construction. Max capacity: 6 lbs

3780S S (3.5" L, 2.75" W, 2.5" H) - \$13.35

3780L L (5" L, 3.5" W, 3.5" H) - \$14.95



5
LBS VIDEO

SQUIDS COLD SHRINK TRAP

Requires no heat source, no additional tools needed for attachment. Uses no adhesives. Can be removed and replaced without a mess. EPDM rubber material resists acids, alkalis, and extreme temps. For tools ranging from .75" - 2.5" DIA.

3723 S (5 lbs, 3") - \$8.65

3724 M (10 lbs, 4") - \$10.35

3726 L (15 lbs, 6") - \$14.95





SEE BAGS WITH CONNECTION POINTS STARTING ON PAGE 114



10 LBS



15 LBS

15 LBS

SQUIDS LOCKING CARABINER

Stretch cord surrounded by tubular nylon webbing, lock stitching at both ends, heavy-duty (500 KGF) self-locking carabiner, adjustable barrel lock for tool attachment, holds up to 10 lbs.

3108 Lime (10 lbs, 28" - 35") - \$20.99

3108FX Orange (15 lbs, 38" - 70") - \$18.99

SQUIDS TRIPLE-LOCKING CARABINER

Stretch cord surrounded by tubular nylon webbing, lock stitching at both ends, heavy-duty (8 kN) triple-locking carabiner, 360° swivel captive-eye, adjustable barrel lock for tool attachment, holds up to 15 lbs.

3109 Lime (15 lbs, 35" - 42") - \$32.99

3109EXT Lime (15 lbs, 42" - 54") - \$30.99

3109FX Orange (25 lbs, 38" - 70") - \$29.99

SQUIDS STAINLESS STEEL CARABINER

Stretch cord surrounded by tubular nylon webbing, lock stitching at both ends, stainless steel carabiners for corrosion resistance, screw gate on carabiner for locking connection, holds up to 15 lbs.

3101 Lime (35" - 42") - \$13.99

3101EXT Lime (42" - 54") - \$20.99



5 LBS

5 LBS

10 LBS



10 LBS



2 LBS

SQUIDS WRIST TOOL TETHER

Holds up to 5 lbs, polyester webbing cuff secures to wrist, ribbed pull cord.

3115SM S-M (5-7" wrist) - \$2.99

3115LXL L-XL (7-9" wrist) - \$2.99

SQUIDS 3102 DETACHABLE WITH CARABINER

Holds up to 5 lbs, aluminum carabiner, quick-connect buckle.

19064 Black (35" - 42") - \$8.99

19065 Lime (35" - 42") - \$8.99

19074 Black (42" - 54") - \$9.99

19075 Lime (42" - 54") - \$9.99

SQUIDS 3100 TOOL TETHER

Holds up to 10 lbs, aluminum carabiner, adjustable barrel lock, lime or black.

19002 Black (35" - 42") - \$9.99

19003 Lime (35" - 42") - \$9.99

19012 Black (42" - 54") - \$9.99

19013 Lime (42" - 54") - \$9.99

SQUIDS 3110 DUAL CARABINER TOOL TETHER

Holds up to 10 lbs, aluminum carabiner on each end, lime or black.

19022 Black (35" - 42") - \$9.99

19023 Lime (35" - 42") - \$9.99

19032 Black (42" - 54") - \$10.99

19033 Lime (42" - 54") - \$10.99

SQUIDS 3130 COILED CABLE TETHER

Holds up to 2 lbs. Constructed with PU covered aircraft cable. Coil design prevents snag and tangle hazards.

19130 Lime (50") \$15.99

3770 Tape measure trap - \$14.99





T-REIGN PROHOLSTER POUCH

Open-top protective case with a retractable tether. Designed for small devices that need protection, but are ruggedly built and need to be within easy reach. Rugged, 36" Kevlar tether is strong and durable. Hook and latch closure system allows one-handed access to gear. Constructed with rugged 600 D nylon, tether cord can stretch to accommodate up to a 6" tall device. 2" W x 1.1" D.

908471 - \$29.99



T-REIGN 902 SERIES HEAVY DUTY RETRACTABLE TETHER

Rugged 48" Kevlar cord; includes a lock that takes tension off the tether, allowing the cord to remain extended; rugged polycarbonate case, weather-proof materials safe to use in any environment, carabiner connector.

OTRG-241 - \$24.99



DBI SALA ADJUSTABLE RADIO / CELL PHONE HOLSTER WITH COILS & MICRO D-RING

Holster is specially designed to adjust perfectly to the size of virtually any small devices such as cell phones, cameras, and radios. A unique mounting system allows the holster to attach easily to harnesses and tool belts.

1500089 - \$30.99



KITS SAVE CASH

GME SUPPLY ACCESSORY PACKAGE

Add-on this package to easily get all the tethering and anchorage accessories you need to go along with your tower climbing gear. Package includes an Elk River Radio Holster, (2) Ergodyne Squids Tool Tethers, and (2) Guardian 3' Anchor Straps. Radio Holster connects to your belt and holds radios or large phones. Tool tethers offer a 10 lb capacity. Anchor straps are rated for users 130-420 lbs.

90120 - \$74.99



Fall Protection



DBI SALA HOOK2LOOP TOOL TETHER

Constructed from a tubular nylon webbing. Carabiner with screw locks that prevent accidental opens.

1500051 - \$42.99



DBI SALA HOOK2LOOP BUNGEE TETHER

Built from custom abrasion-resistant webbing for durability and longevity, features a twist-locking carabiner, 31" - 52".

1500049 - \$31.99

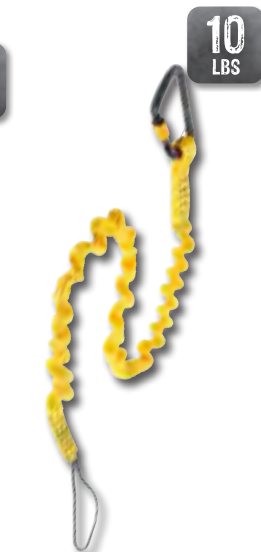

DBI SALA HOOK2LOOP BUNGEE TETHER

Versatile extension for use with any tool under 10 lbs, locking carabiner and choker loop, 5/8" tubular webbing, 32" - 47".

1500047 - \$14.99



DBI SALA D-RING ATTACHMENT 10 PACK

1" x 3.5". Holds up to 5 lbs. These D-Rings are used with quick wrap tape to create instant attachment points.

1500007 - \$38.99

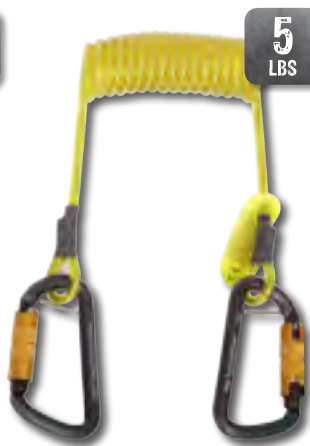

DBI SALA HOOK2HOOK COIL TETHER

Made from vinyl-coated braided steel coil. Self-locking aluminum carabiners. Relaxed length of 5" and stretched length of 62", this tool tether is designed to stay out of the way when not in use.

1500063 - \$16.99



DBI SALA CLIP2LOOP COIL TETHER 10 PACK

Holds up to 2 lbs. The ballistic nylon heavy-duty swivel snap quickly attaches to any D-ring attachment. While a side release loop attachment provides a quick and secure solution to tethering.

1500060 - \$101.99



JOHNSON LEVEL AUTO-LOCK POWER TAPE MEASURE

25' X 1". Auto-lock features self-locking blade with a push button retrieval. Blade-Guard nylon coated blade resists abrasion. Speed-read blade features fractional graduations every 1/8". 4-rivet blade hook. Impact resistant ergonomic co-molded rubberized case.

1804-0025 - \$8.99



JOHNSON JOB SITE OPEN REEL FIBERGLASS TAPE MEASURE

Durable steel end hook with loop, 2-color blade: white inch scale, yellow engineer's scale, comfortable non-slip rubberized hand grip, rugged, high impact ABS Case.

1808-0100 100' - \$14.99

1808-0300 300' - \$40.99



KLEIN TOOLS FISH TAPE

Steel, laser etched 1' increments, polypropylene case/handle, raised finger grips, 1/8".

56002 65' - \$35.99

56003 125' - \$48.99

56004 240' - \$67.99

Fiberglass non-conductive tape decreases the risk of shock around energized circuits.

56023 100' - \$100.99



KLEIN TOOLS NON-CONTACT VOLTAGE TESTER

Automatically detects and indicates low voltage (12-48 V AC) and standard voltage (48-1000 V AC) allowing broad application; Non-contact detection of standard voltage in cable, cords, circuit breakers, lighting fixtures, switches, outlets and wires; High intensity, bright green LED indicates the tester is operational and aids in illuminating the workspace; 9.8' drop protection; Conforms to CE requirements.

69000 - \$18.99



JOHNSON LEVEL 3' STRUCTO-CAST MEASURING WHEEL

5 digit, easy-read magnified counter accurately measures up to 9,999'. 3-piece telescoping aluminum handle with pistol grip and safety reflector, extends from 18" - 42". Durable, rubber tire - 12.5" diameter. Ergonomic non-slip grip. Convenient folding stand.

1877-0200 - \$79.95



JOHNSON MAGNETIC ALUMINUM REINFORCED TORPEDO LEVEL

Aluminum reinforced frame, rubber magnetic working edge allows for hands-free use on ferrous metal surfaces, V-groove frame fits on pipe and conduit, tapered ends assure an easy fit into tool belts, tool pouches or work pant pockets, surround view vials reflect ambient light for easy-read, oversized frame, Multi-Pitch vial reads slope in 1/8" increments.

1401-0900 9" Length - \$9.99

1401-1200 12" Length - \$11.99



JOHNSON DIGITAL BOX LEVEL WITH ROTATING DISPLAY & GLOW VIEW REG TECHNOLOGY

Surround view vials reflect ambient light for easy-read, Quick horizontal and vertical calibration, automatic digit inversion for overhead measurements, hold function locks measurement on LCD, extremely accurate with 0.05° at 0° and 90°, angle inclination in 5 construction languages - units of measure (degrees, percent, in/ft (fractional), in/ft (decimal, mm/m), working range on angle measurement 4 x 90°, IP 65 dust and waterproof.

1880-2400 24" Length - \$164.99

1880-4800 48" Length - \$194.99



JOHNSON MAGNETIC TORPEDO LASER LEVEL

7" x 2" 0.875". (3) vials read plumb, level, and cross check; projects laser dot, horizontal and vertical lines for versatile use; interior range up to 100', accurate to +/- 3/8" at 50' for great precision, durable molded housing is impact resistant, magnetic edge holds the tool securely to non-ferrous metals, includes (2) "AAA" batteries.

40-0915 7" Length - \$19.99



JOHNSON MAGNETIC DIGITAL LEVEL

5 units of measure (degrees, percent, mm/m, in/ft in decimal, in/ft in fractional), automatic digit inversion for overhead measurements, backlight for easy-read in dimly lit work environment, powerful grip tight rare earth magnets hold to ferrous metal surfaces, push button calibration, audible indicator at 0° and 90°. Includes (3) "AAA" alkaline batteries, instruction manual, and soft-sided pouch.

40-6060 6" Length - \$130.00



STANLEY TOP READ ALUMINUM LEVEL

An ideal lightweight, professional grade aluminum level for construction use; top-read center vial designed for easy readability, yellow vial covers for high visibility and easier reading vials, shock-absorbing end caps hold up to heavy use and prevent denting, hang hole simplifies storage, limited lifetime warranty.

680-42-076 48" Length - \$13.99





TIMES MICROWAVE LMR300 & 400 CRIMP TOOL .324" & .429"

Ratcheting crimper for LMR300 and LMR400 cables with corresponding crimp-style connectors has a fixed die set, the die set has 2-cavities, crimping to 0.324 and 0.429 inch hex; rated at 50,000 cycles, yellow handles make this cable crimping tool easy to locate.
CT-400/300 - \$124.99



GREENLEE CRIMPING TOOL 8-1 AWG

Small size and light weight make this an ideal tool for crimping small lugs and splices, easily fits in tool pouches, full-cycle mechanism assures that crimps are complete, jaws can be opened in mid-cycle if necessary to adjust connector, wide grips make crimping easy on the hands.
K1111 - \$359.99



THOMAS & BETTS COLOR-KEYED MANUAL CRIMP TOOL

Color-Keyed compression tool, comfort crimp ergonomic design, shure-stake ratchet, rotating die wheel, color-coded die nests, die code embossment, works on #8-#2 copper and #10-#6 aluminum lugs and splices, also for green 54705-54727 C-taps and MD2.
TBM45S - \$265.99



WEATHERFLOW WIND METER

WeatherFlow's Wind Meter is small enough to fit in your pocket, and works with your smartphone to collect real time wind, temperature, humidity, and pressure readings. This handheld anemometer is compatible with your iPhone, iPad, iPod and Android devices. With corresponding app, plug the wind meter into your device's audio jack and measure wind speed, direction, and location. Measures wind speed (avg., gust., apparent., true), wind direction (magnetic and true), crosswind and headwind/tailwind; operating range: 2 mph - 125 mph; accuracy: +/- 0.5%; Plugs into 3.5 mm smartphone audio jack.
WFANO-01B-MC - \$39.99



KESTREL 3000 WEATHER METER

Rugged anemometer, measures air/water/snow temperature, wind chill, current/average/maximum wind speeds. Impeller-mounted in a high-performance polyamide for strength and durability. Low startup speed and precise wind readings. Protective over molded case. Large backlit LCD. Waterproof. Drop tested. Accurate NIST-traceable measurements. Includes replaceable CR2032 coin cell battery, 5-year warranty.
0830 Weather meter - \$199.99
0820 Wind meter - \$134.99



COMMSCOPE 1-1/4" TORQUE WRENCH FOR 7/16" DIN CONNECTOR HEX COUPLING NUT

Andrew 1-1/4" torque wrench for 7-16 DIN coupling nut, designed with a mechanism to audibly notify the installer that proper torque has been reached.
244377 - \$94.99



JMA TORQUE WRENCH FOR 1/2" CONNECTORS, 3/4" OPENING

For N Style 1/2" PPC compression connectors; 3/4" opening; 14 in/lbs of torque; 13.2" length; Steel construction.
TW1412 - \$129.99



COMMSCOPE TORQUE WRENCH FOR COUPLING TORQUE OF TYPE-N CONNECTORS 13/16" OPENING

Andrew 13/16" torque wrench for Type-N coupling nut for Andrew Cable, audible click when the proper torque has been reached.
244379 - \$99.99



COMMSCOPE TORQUE WRENCH FOR 7/8" EZFIT CONNECTORS 1" OPENING

Andrew torque wrench for 7/8" 780 EZfit connectors, for use with FXL-780 and AVA5 cable, audible click when torque has been reached.
TW-78-EZFC - \$97.99



JMA TORQUE WRENCH 7/8" 8 FT LB, DIN CONNECTOR

PPC click-style torque wrench for Andrew 7-18 DIN coupling nut, pre-set to 8' lb. OAL is 11-1/4" blue handle.
TQ-78-F8 - \$220.00





ODM TTK 650 COMPLETE INSPECTION & SINGLE MODE TEST KIT

USB connectivity to included 8" tablet allows for automated and manual fiber end face inspection. Comprehensive pass/fail analysis compliant with IEC 61300-3-35 industry standard. Optical power meter with archiving ability and live-streaming data to tablet or laptop via USB. Included laser light source provides standard wavelengths for testing loss in single mode systems. Red laser allows observation of bends and breaks in fibers under test. Includes all patchcords and adapters necessary, cleaning tools and closeout report software.

TTK 650 - \$3,895.00



JMA WIRELESS COMPLETE TOOL KIT

The JMA Wireless Complete Compression Tool Kit is for 1/2", 7/8", and 1-5/8" CC connectors. Kit Includes: (3) Frame sets, (2) Inserts, (2) Batteries, Battery Charger, Gator Crimp frames, cable cutters, cable prep tools (SP-1/2-LDF4D, SP-12S, SP-78, SP-158), case, TQ-114-F18 DIN torque wrench.

KIT-CC-FULL - \$5,609.99

JMA WIRELESS HALF TOOL KIT

The JMA Wireless Complete Compression Tool Kit is for 1/2" CC connectors. Kit Includes: 1/2" Frame set, (2) Inserts, (2) Batteries, Battery Charger, Gator Crimp frames, cable cutters, cable prep tools (SP-1/2-LDF4D, SP-12S), case, TQ-114-F18 DIN torque wrench.

KIT-CC-HALF - \$4,090.00



ODM TTK 720 FULL SINGLE MODE FTTA TEST KIT

VIS 300C-PM-02-V test platform provides full control over all parameters for fiber end-face inspection, insertion loss, and visual fault location tests. HD inspection scope with interchangeable inspection tips, analysis button, and ODM's unique external focus mechanism. Optical power meter with Germanium detector provides insertion loss (dB) and power level (dBm) results in simple pass/fail format. 635 nm red laser VFL for identification of excessive bends and breaks in SM fiber. Includes all patchcords and adapters necessary, cleaning tools and closeout report software.

TTK 720 - \$3,695.00



COMMSCOPE CONTROL UNIT INTERFACE ADAPTER KIT

Carried from site to site for RET antenna setup and optimization, supports up to 32 RET actuators operating in a mix of AISG modes, LED display indicates the presence of input power, output power, and data communication, equipped with USB and serial connectors, power supply efficiency is Energy Star Level IV rated.

ATC200-LITE-USB - \$624.99



KATHREIN USA INC. PORTABLE CONTROL ADAPTER

SCALA Portable Control adapter, (1) 8 pin connector according to IEC 60130-9, female, conforms to AISG; includes PCA, external power supply, USB cable, AC power cable, CD-ROM (with PCA software, drivers, and manual), installation guide, and carrying case.

860-10046 - \$549.99



COMMSCOPE ALUMINUM PREP TOOL FOR SG SERIES

Aluminum grounding kit preparation tool prepares cable for grounding kit attachment. 150 cable preparations cutting blade life. (1) cutting blade included. 3.1" H, 0.9" L, 0.9" W, 0.92 lbs.

GKT-158SG - \$199.99





COMMSCOPE WAVEGUIDE FLARING TOOL KIT

Made for use with Heliac EWP63S, EWP63, and EW63 elliptical waveguide cable, produces consistently accurate waveguide flares for connector and splice attachments, includes major-axis flaring tool, minor-axis flaring tool, and a rugged carrying case.

ANDEWFTK-63 - \$875.00



COMMSCOPE TELETILT BOTTOM SMART BIAS TEE

Injects AISG power and control signals onto a coaxial cable line, reduces cable and site lease costs by eliminating the need for AISG home run cables, AISG 1.1 and 2.0 compliant, operates at 10-30 VDC.

ATSBT-BOTTOM-FM-4G - \$462.99



COMMSCOPE 7/8" EZFIT CABLE PREPARATION CORING TOOL FOR FXL-780 COAXIAL CABLE

Automated cable preparation tool. Prepares cable for connector attachment. Includes (2) cutting blades for connector attachment, (2) cutting blades, cutting tool body, FXL-780 cutting bit, and hex wrench.

780-EZPT - \$359.99



COMMSCOPE 1/2" EASIAx PLUS CABLE PREPARATION TOOL FOR FSJ4-50B CONNECTORS

Automated cable preparation tool, prepares cable for connector attachment. Includes (2) combination blades. Cutting blade life of (150) cable preparations.

CPT-F4B - \$139.99



COMMSCOPE EASIAx PLUS CABLE PREPARATION TOOL FOR 1-5/8" COAXIAL CABLE

Automated cable preparation tool, prepares cable for connector attachment. Includes (2) cutting blades and jacket blades. Cutting blade life of (150) cable preparations.

CPT-158U For 1-5/8" - \$298.99

CPT-78U For 7/8" coaxial cable - \$235.99

CPT-12U For 1/2" coaxial cable - \$210.99



COMMSCOPE 1-1/4" EZFIT CABLE PREPARATION CORING TOOL FOR FXL-1480 COAXIAL CABLE

Automated cable preparation tool, prepares cable for connector attachment. Includes cutting tool body, FXL-1480 cutting bit, FXL-1480 flaring bit, and hex wrench. For 1-1/4" cell reach and extreme flex FXL coaxial cable using B-series connectors.

1480-PT - \$374.99



COMMSCOPE 1-5/8" EZFIT AUTOMATED CABLE PREPARATION TOOL FOR FXL-1873 COAXIAL CABLE

Automated cable preparation tool, prepares cable for connector attachment. Includes (2) cutting blades and (1) jacket blade. ISO 9001:2008.

FXL/CR-1873-PT - \$325.00



REPLACEMENT BLADE KIT

Replacement blade kit for CPT-F4B automated cable preparation tools.

CPT-BKSF4 - \$75.00



TIMES MICROWAVE LMR-400 PREP TOOL FOR VIRTUALLY ALL CONNECTORS

Made for use with 3/8 inch LMR-400 coaxial cable using crimp and clamp-style connectors; this cable hand prep tool joins a cable stripper tool and a cable trimming tool into one easy-to-use device.

CST-400 - \$98.95



TIMES MICROWAVE LMR-240 PREP TOOL FOR VIRTUALLY ALL CONNECTORS

All-in-one combination prep tool for prep of LMR240 cables for crimp or clamp connectors.

CST-240A - \$110.00



TIMES MICROWAVE LMR-195 & LMR-200 CABLE PREP TOOL

All-in-one strip tool, combination allows for prep of crimp or clamp connectors, built-in deburr tool.

CST-195-200 - \$99.95



ProTalk®

THE RIGHT TOOL THE RIGHT CHOICE

Compact, durable business two-way radios from Kenwood



▶ ASK ABOUT OUR REBATES

KENWOOD
BEST IN CLASS TWO-WAY RADIOS



KENWOOD PROTALK 2 WATT 16 CHANNEL RADIO

Ergonomically contoured and engineered for superb ease of use and audio clarity, even in noisy environments, ProTalk boasts rugged reliability for dependable communications in all weather conditions. Specially designed "Stubby" antenna reduces overall radio size without loss of signal or reception.

TK-3400U16PS - \$219.00



KENWOOD NYLON CARRYING CASE

Black nylon case that allows access to the radio's controls in the case, allowing use of the radio without taking the case off. Protects radio, snapping belt loop, superior quality, 1-year warranty.

KLH-187 For TK-2400, TK-3400, TK-2402, TK-3402 - \$15.00

KLH-150 For TK-3230 - \$15.00



KENWOOD COMPACT SPEAKER MIC

Plugs directly into a ProTalk or FreeTalk radio and offers an incorporated push-to-talk button. This speaker microphone features a compact, low-profile design.

KMC-21 Compatible with TK-3400 & TK-3230 radios - \$49.99

KMC-45 Compatible with TK-2300/3300UP & TK-3230XLS radios - \$89.99



KENWOOD RAPID CHARGER

Kenwood's KSC-35SK rapid-rate desktop charger replenishes the charge on a single Kenwood KNB-45L 2000 mAh Li-Ion battery for TK Series two-way radios, 1-year warranty.

KSC-35SK - \$31.49

KENWOOD SIX UNIT CHARGING RACK

Provides power to (6) KSC-35K chargers, allowing you to charge up to (6) radios simultaneously, compatible with Kenwood TK-2400, 3400, 2402 and 3402 radio series, charging cups included with radios, 1-year warranty.

KMB-28 - \$199.99

DEMO UNITS AVAILABLE CALL FOR DETAILS

TK-3400U16PS SPECIFICATIONS

16 Channel UHF 2 Watt
Wireless Cloning
90 UHF Programmed Banked Frequencies
39 QT / 168 DQT Privacy Codes
Diecast Chassis
Weather Sealed Construction
1 Watt Audio Output
Removable Antenna
2,000 mAh Li-Ion Battery with up to 22 Hours of Talk Time
Advanced Ergonomic Controls
Fast 2.5-3 Hour Charge Time
Weights Only 9.9 oz with Battery
Meets Military Spec 810 Standards
Compatible with Other Business Radios Operating on the Same Frequency & Code
Up to 6 Mile Range in Opens Areas

Includes Radio, Antenna, Battery, Fast Charger, Belt Clip, & Owner's Manual



2 Year Warranty



KENWOOD 1.5-WATT PROTALK LT POCKET-SIZED RADIO

Weighing just 3.9 oz, this small but powerful two-way radio provides 1.5 watts transmit power, (4) channels, enhanced Kenwood audio, 3.5 mm audio jack for hands free operation, LED battery status indicator, battery saver, time out function, wireless clone, 2-year warranty. Connect to a standard micro USB port to charge or use included charging cup, meets 8 Mil-Spec standards. Includes 1,430 mAh Li-Ion battery, 3-hour fast charger, and belt clip.

PKT-23 Radio - \$144.00

KHS-33 Earbud headset - \$28.00

KHS-34 C-Ring headset - \$35.00

KMB-44 6 Unit charging rack - \$167.00

KENWOOD PROTALK UHF PORTABLE RADIO

5W (136-174 MHz, 400-470 MHz, 450-520 MHz) Models, max 16 CH per zone, (2) conventional zones, 4-color LED, 2 PF keys, 1.0 W speaker audio, 16-position mechanical selector, zone / CH# voice announcement, VOX ready, emergency call features, lone worker alert, time out timer, busy channel lockout, KPG-170D Windows FPU, wireless cloning, password protected, IP-54/55 water and dust intrusion.

NX-340U16P - \$359.99



KENWOOD PROTALK UHF PORTABLE RADIO

UHF 16 Channels, 5 Watt; 39 QT / 168 DQT privacy codes, super lock, VOX ready, privacy talk scrambler, 10-call alert tone wireless cloning, channel scan, removable antenna, diecast chassis, weather-sealed construction, meets 11 Mil-Spec standards, Li-Ion rechargeable battery, spring action belt clip, fast charging cup, removable antenna, 2-year radio warranty.

TK-3402U16P - \$274.00



GO TO WWW.GMESUPPLY.COM/DEVICES TO VIEW ENTIRE DEVICES SELECTION ONLINE

TK-3230DX SPECIFICATIONS
6 Channel UHF 1.5 Watt
Wireless Cloning
64 Pre-Set Frequencies
39 QT / 168 DQT Privacy Codes
Enhanced Kenwood Audio
10 Call Alert Tones
Wireless Cloning
4-Digit 7-Segment LCD with Backlight
2,000 mAh Li-Ion Battery Offering up to 18 Hours of Operation
VOX Ready
Fast 2.5 Hour Charge Time
Weighs Only 5.5 oz with Battery
Meets Military Spec 810 Standards
Compatible with Other Business Radios Operating on the Same Frequency & Code
Up to 5 Mile Range in Opens Areas
Includes Radio, Battery, Fast Charger, Belt Clip, & Owner's Manual
2 Year Warranty

T-REIGN PROHOLSTER POUCH

Designed for two-way radios or any other small device. Constructed with rugged 600 D nylon. Rugged 36" retractable Kevlar tether is strong and durable and can stretch to accommodate up to a 6" H, 2" W, 1.1" L device.

908471 - \$29.99

KENWOOD LI-ION REPLACEMENT BATTERY

High quality lithium ion DC 3.7 V, 2000 mAh cell that is designed to work with the Kenwood TK-3230 series radios, 1-year warranty.

KNB-46L TK-3230 - \$48.99

KNB-45L TK-3400U4P - \$62.99

KENWOOD D-RING HEADSET

Soft rubber D-ring ear loop hanger with speaker, ear loop can be worn on either ear, lightweight and balanced to provide all day comfort, in-line PTT with clothing clip, compatible with TK-3400 and 3230, 1-year warranty.

KHS-27 - \$25.00

KENWOOD IP67 RATED SPEAKER MIC FOR NX-P500 TWO-WAY RADIO

Works with the Kenwood NX-P500 2-way radio. Features an inline Push-to-Talk (PTT) button and lapel clip to fasten the earpiece securely to a shirt or harness.

KMC-55W - \$117.00



KENWOOD PROTALK 2-WATT DUAL-MODE PORTABLE RADIO

The Kenwood ProTalk 2 Watt Portable Radio is a lightweight, 6-channel radio featuring both NXDN digital and FM analog modes. Features approximately 15.5-hour long battery life with the save feature on. IP54/55/67 and MIL-STD-810 C/D/E/F/G. 5.6 ounces. Frequency Range: 450 - 470 MHz.

NX-P500 - \$239.00



KENWOOD RAPID CHARGER

Rapid rate desktop charger that is designed to work with the Kenwood TK-3230 series radios, compatible with KNB-46L Lithium Ion Battery Pack, great as a replacement or spare, 1-year warranty.

KSC-37 - \$31.49



KENWOOD SIX UNIT CHARGING RACK

Provides power to (6) KSC-28 or KSC-37 chargers, allowing you to charge up to (6) radios simultaneously, compatible with Kenwood TK-3230 radio series, charging cups included with radios, 1-year warranty.

KMB-27 - \$199.99

KENWOOD 1.5 WATT PROTALK UHF BUSINESS RADIO

Two-way radio specially designed for demanding use with clear communications in a small compact size (5.5 oz with battery). You can't beat this combination of power, size, and battery life!

TK-3230DX - \$164.00





MOTOROLA

MOTOROLA RM SERIES CHARGER

Chargers for RM Series. Compact design allows you to place it virtually anywhere.

PMLN6394 1-unit - \$35.00
PMLN6384 6-unit - \$299.00



MOTOROLA DLR SERIES CHARGER

Chargers for DLR Series. Compact design allows you to place it virtually anywhere.

PMLN7140 1-unit - \$45.00
PMLN7136 12-unit - \$329.00



MOTOROLA LITHIUM-ION BATTERY

High performance batteries are designed to be as reliable as your radio. Lightweight and slim, Li-ion batteries offer reliable communication with higher capacity in a smaller package. IP54 rated.

PMNN4434 RM Series - \$65.00
HKNN4013 DLR Series - \$40.00



PMNN4434

HKNN4013

MOTOROLA HOLSTER

Carry holster is slim and lightweight. When paired with audio accessories, carry holster enable hands-free communication. Designed to easily slide the radio into place and quickly remove it when desired.

HKLN4510 RM Series - \$20.00
HKLN4615 DLR Series - \$20.00



HKLN4510

HKLN4615



MOTOROLA ON-SITE TWO-WAY BUSINESS RADIO

2 Watt. 4 Channel, Up to 15 hours battery life, Lithium Ion. Up to 20 floors or 250,000 sq ft coverage area. 450-470 MHz frequency range. (99) UHF frequencies make signals extra-secure and exceptionally clear. Takes on tough conditions with a durable metal diecast chassis that meets Military Standards and IP54/55 specs. Anti-microbial protection helps prevent the growth of mold and germs. Tri-color LED easily identifies different radio features and radio status.

RMU2040 Radio - \$245.00

ONE WEEK NO RISK FREE TRIAL



MOTOROLA DIGITAL ON-SITE TWO-WAY RADIO

1 W Digital 900 MHZ ISM band. Up to 14 hours battery life. 6-channel radio with DLR digital technology. Up to 20 floors or 300,000 sq ft coverage area. Voice communications are louder and clearer across an extended range without static. Private Reply feature allows users to instantly communicate one to one privately after a group transmission is over. Call All Available or Page All Available features are flexible group communications that can reach all users available. DLR radios meet test methods for military standards 810 C, D, E, F, and G.

DLR1060 Radio - \$259.00
DLR1020 2-Channel radio - \$239.00



MOTOROLA WHISPER UNIVERSAL BLUETOOTH HEADSET

Offers cutting-edge clarity for when it's important to hear and be heard. With quad-microphone CrystalTalk DSP Noise Reduction, you can take a call in any environment. A retractable boom extends to further improve clarity in noisy areas. Includes five unique eargel cushions plus two earhooks for an extra secure, comfortable fit. Can be worn on the left or right ear.

HZ850 - \$59.95

MOTOROLA ON-SITE TWO-WAY BUSINESS RADIO

1 Watt, up to 12 hours battery life, Lithium Ion, up to 200,000 sq ft. (15 Floors) coverage area. 461-470 MHz frequency range. VibraCall alert lets users discreetly receive transmissions. Uses (4) channels and operates on (56) business-exclusive frequencies, private line codes, (121) interference eliminator codes maximize choices through (83) digital and (38) analog private lines. Voice-operated transmit enables hands-free operation. Simplified cloning quickly copies settings from radio to radio. Choice of rechargeable lithium ion or backup AAA. 1-year standard warranty.

CLS1410 - \$209.00



MOTOROLA DURABLE REMOTE SPEAKER MICROPHONE

Conveniently clips to your front lapel or pocket allowing you to talk and listen without removing your radio from the belt or case. Built and rigorously tested to the same quality standards as Motorola radios. Includes speaker, microphone, and push-to-talk button. Compatible with CLS1410 and RMU2040.

HKLN4606 - \$63.00



Here at Anritsu, we are known for RF.



Site Master™

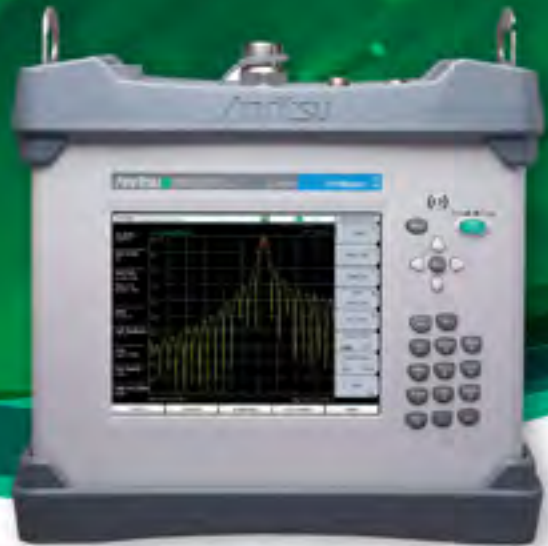

PIM Master™

We Do Optical Too!



Network Master™ Pro



Access Master™



Network Master™

We offer RF + Optical to suit all of Your needs!

Learn more about our entire suite of products including a full line of accessories!

<https://www.gmesupply.com/brands/anritsu>

1-800-ANRITSU
© 2019 Anritsu Company

Anritsu
envision : ensure



NEW **QUICK SHIP** **VIDEO**

ANRITSU SITE MASTER S331E COMPACT HANDHELD CABLE AND ANTENNA ANALYZER

Allows you to quickly service and maintain legacy networks in addition to the newer 3G and 4G networks. Delivers ease of use, rich functionality, and best-in-class price and performance. Designed to handle the most punishing field conditions and enhance your productivity while transforming the traditional fix-after-failure maintenance model to one that identifies and fixes problems before major failures occur. Features easyTest Tools to allow experienced users to create, deliver, and display on-screen work instructions for Cable and Antenna testers. Work instructions make life easier for less-experienced cable and antenna sweepers. Direct benefits of the Site Master include more accurate testing, repeatable results, and less rework.

S331E - \$8,133.06



NEW **VIDEO**

ANRITSU MT9085 SERIES OTDR-ACCESS MASTER

8-inch LCD with easy visibility even in direct sunlight. Better work efficiency with the synergy of LCD touchscreen, rotary knob, and dedicated hard keys. Easy-to-Use Fiber Visualizer function for simple fiber path analysis. Fast fiber bend location using high-speed, high S/N real-time sweep modes. High-accuracy event detection and loss measurement (46-dB dynamic range max., 0.8 m event dead zone). Identification of each splitter event and up to 1x128 branches. Optical loss test and optical power measurement with a built-in light source, optical power meter, and visible light source options. Optical fiber end-face inspection using external fiberscope option.

MT9085A-053-BSC - \$7,841.00



NEW

ANRITSU NETWORK MASTER WITH UOTDR MODULE

Compact - easily held with one hand. Lightweight - less than 800g (2 lbs.). Modular platform ensures maximum return on investment. High resolution, 4.3 in. widescreen color display - easy to read indoors or out. The rugged, sealed design provides years of service in the most challenging environments. Micro OTDR (μOTDR) - a full-featured OTDR for the installation and maintenance of optical networks in a pocket-sized package.

Z1490A - \$5,807.00



NEW

ANRITSU MT1000A NETWORK MASTER PRO

One-button network commissioning tests and easy network installation and maintenance. Compact, rugged design provides years of service in the most challenging environments. Large 9-inch enhanced display for easy viewing of results indoors or outdoors. Linux OS provides quick boot up and stable, virus-free operation. Easy and intuitive GUI. Simple SETUP, TEST, RESULTS in three window operation. Modular design with field-installable modules and options maximizes your investment. WiFi/Bluetooth/LAN connectivity.

MT1000A - \$3,727.00



NEW

ANRITSU PIM MASTER

Passive Intermodulation (PIM) Analyzer. PIM vs. Time, Swept PIM, Distance-to-PIM, Noise Floor. Battery-Operated: approximately 3 hour. Field-proven design: Rugged, compact, daylight viewable display. Compatible with SweepMasters SkyBridge Tools cloud-based trace management tool. Standard three-year warranty (battery one-year warranty).

MW82119B (Base) - \$900.00

MW82119B-0194 (PCS/AWS) - \$21,550.00

MW82119B-0700 (LTE 700) - \$20,650.00

MW82119B-0800 (LTE 800) - \$21,550.00

MW82119B-0850 (Cellular 850) - \$20,650.00





NEW

ANRITSU PHASE-STABLE TEST PORT EXTENSION CABLES (1.5 M)

Torque Resistant. Crush Resistant: 500 pounds/linear inch. Tight Bend Radius. Wide Temperature Range. Abrasion Resistant. Chemically Inert and Resistant. Lightweight Fiber Braided Jacket. High Connector Pull Strength.

15RNF50-1.5-R - \$640.00



NEW

ANRITSU SITE MASTER ULTRAPORTABLE CABLE AND ANTENNA ANALYZER

Smallest, lightest, and fastest Site Master. Rugged and reliable. Impact, dust and splash resistant. Factory default 1-Port ReadyCal. Compatible with Anritsu Software tools including easy Test Tools.

S331P - \$2,000.00

S331P-0704 - \$4,000.00

S331P-0706 - \$5,000.00



NEW

ANRITSU CALIBRATION KIT MALE, DC TO 8GHZ

Wide operating temperature. Single Component providing full open, short and load reflection standards for accurate measurements. 50-ohm Impedance. The recommended calibration interval is 1 year.

OSLN50A-8 - \$795.00



NEW

ANRITSU CALIBRATION KIT FEMALE, DC TO 8GHZ

Wide operating temperature. Single Component providing full open, short and load reflection standards for accurate measurements. 50-ohm Impedance. The recommended calibration interval is 1 year.

OSLNF50A-8 - \$795.00



NEW

ANRITSU PIM MASTER HARD CASE ACCESSORY KIT

Transit Case. PIM Test Cable. Low PIM Termination. PIM standard. Low PIM Adapters. Adjustable Wrench. 1 1/4 Inch Torque Wrench. Cleaning Wipes. Cleaning Swabs.

2000-1746-R - \$2,615.00



NEW

ANRITSU ADAPTER, DC TO 6 GHZ

Operational from DC – 6 GHz. Robust design for long product life. Low Insertion Loss. Exceptional PIM performance across cellular or wireless frequency range.

1091-467-R (M to F) - \$85.00

1091-465-R (F to F) - \$85.00



NEW

ANRITSU G0382A AUTOFOCUS VIDEO INSPECTION PROBE

Fully automated one-button operation. Highest speed measurement. Easy to read LED indicator displaying the status. Compact and lightweight. Wide range of adaptors available.

G0382A - \$3,366.00



NEW

ANRITSU CALIBRATION KIT WITH CASE, TYPE 4.3-10, DC TO 6 GHZ, MALE

Calibration Kit comes in a male connection and measures specifications from DC to 6 GHz. Wide operating temperature, this device is ready to test your work when you are.

2000-1915-R - \$1,605.00



NEW

ANRITSU CALIBRATION KIT, TYPE 4.3-10, DC TO 6 GHZ, FEMALE

Calibration Kit comes in 7/16 female connection and measures specifications from DC to 6 GHz. Wide operating temperature, this device is ready to test your work when you are.

2000-1619-R - \$675.00



NEW

ANRITSU ADAPTER N TYPE MODEL

Adapter is ideal for your testing needs it is engineered to the highest quality. Every adapter is fully specified and 100% tested to ensure low reflections and optimum phase performance. Precision adapters enable accurate measurements. Low SWR and insertion loss. Convenient transition with minimal effect on the signal.

34NFN50 - \$412.00



NEW

ANRITSU PRECISION LOAD SM/PL SERIES

Meets EU conformity standards. Male Precision Load Measurements. DC to 6 GHz. Return Loss: 42 dB.

SM/PL-1 - \$325.00





ANTENNA ALIGNMENT FROM

\$5,995

MORE ACCURACY, FASTER RESULTS, ~~OR~~ **AND** LOWER COST.

They say you can only pick two of the three. Not with the SmartAligner. Whether you're upgrading your network, managing a deployment project, or aligning antennas on the tower, the SmartAligner checks every box. It's dead-on accurate. It provides readings with lightning speed. And it's now more affordable than ever. It really is like no other antenna alignment tool.

Smart  **Aligner**
by MultiWave Sensors
LIKE NO OTHER ANTENNA ALIGNMENT TOOL

CARRIERS

Accuracy
RF environment
Future proof

TURF

Improved reporting
Decreased user error
Lower site revisits

CONTRACTORS

Speed
Cost savings
Flexibility



CALL GME SUPPLY
(800) 940-6762

MULTIWAVE SMARTALIGN ANTENNA ALIGNMENT SYSTEM

The Multiwave SmartAlign Antenna Alignment System is a GPS-based compass designed to effectively and efficiently align your antennas in real time. The SmartAligner solution is designed for ease of use and unparalleled accuracy that provides a True North or Grid North azimuth measurement, Tilt, Roll and Position. Once the system is mounted to the antenna, it is simply turned on. From there the user interface is the full feature app on any iOS and Android smart device. Reporting is as simple as a few clicks with the report being able to be e-mailed directly from the app. The system has been tested in the harshest RF live antenna environment while still maintaining it's accuracy. The SmartAligner solution is accurate, fast and scalable creating an effective solution for all your alignment needs. First foldable GPS antenna alignment tool. Universal mounting bracket. Multiple antenna mounting configurations for the most demanding spatial and RF conditions. Tool and bracket fit into ruggedized case. Carry on baggage acceptable size. Includes Extra Tall TCPD Pouch to carry the tool and bracket. Weighs only 10 lbs. Free smartphone app.

SMARTALIGN - \$5,995.00



SmartAligner
by MultiWave Sensors

ASK ABOUT FINANCING OPTIONS



MULTIWAVE EXTRA TALL TCPD POUCH

16" height, 9" length, 5" width, 3 exterior D-ring connection points, extra tough Cordura closing top with drawstring, bull-pin loop on each side, inside pocket, tunnel loop belt connection, up to 3" wide belt capacity.

5516MW - \$49.99



MULTIWAVE BACKPACK

The Multiwave Backpack makes transporting the SmartAligner up the tower easy, protects device while climber ascends to platform to work, extra pockets allow separate storage of logs, extra tools, laser rangefinder, or smartphone.

BACKPACK - \$75.00



MULTIWAVE SMARTALIGNER RUGGEDIZED CARRYING CASE

Has enough room and compartments to hold the SmartAligner, bracket, and all the components. Use this rugged carrying case for shipping or transporting the Multiwave SmartAligner. The SmartAligner Carrying case is even an approved size to be used as carry on baggage while flying. Weighs 12 lbs, 21" x 16" x 8.5".

SMARTCASE - \$500.00



MULTIWAVE SMART ALIGNER DISH BRACKET MOUNT

Attaches to dish bracket horizontal bar. Provides mounting base for tool. Tether included. Hex key included for assembly with directions. Horizontal bar comes in 4 sizes for different dish diameters: 2' bar for 1.5'- 2' diameter dishes, 3' bar for 1.5'- 4' diameter dishes, 4' bar for 1.5'- 8' diameter dishes, 6' bar for 1.5'- 16' diameter dishes.

DISHBRACKETMOUNT - \$200.00

DISHBRACKETHB2 2' Bar - \$85.00

DISHBRACKETHB3 3' Bar - \$110.00

DISHBRACKETHB4 4' Bar - \$135.00

DISHBRACKETHB6 6' Bar - \$175.00



MULTIWAVE DISH ADAPTER

Microwave dishes come in a variety of shapes and sizes. The Multiwave Dish Adapter enables the user to attach the SmartAligner to their own custom bracket they have fabricated.

DISHADAPTER - \$50.00

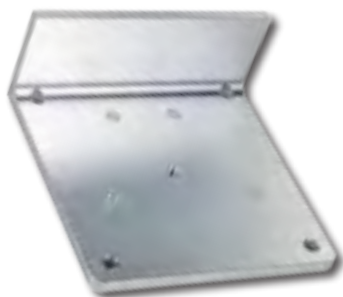

MULTIWAVE SMARTALIGNER INSERT

Install the Insert into Multiwave's Universal Bracket to ensure greater accuracy when working with AIR antennas.

AIR21INSERT - \$175.00

AIR32INSERT - \$150.00



AIR32 Insert



AIR21 Insert

MULTIWAVE SMARTALIGNER UNIVERSAL BRACKET

The Multiwave SmartAligner Universal Bracket attaches directly to the left or right side of the antenna to be aligned. The SmartAligner tool can then be attached to the universal bracket in three different positions. Comes included with the purchase of the SmartAligner Antenna Alignment System. Purchase an extra Universal Bracket as a replacement or spare. The Universal Bracket fits into the Multiwave carrying case (sold separately) for easy transportation. Tether line to prevent drops. Durable ratchet to ensure secure connection.

UNIVERSALBRACKET - \$600.00

MULTIWAVE 2-YEAR EXTENDED WARRANTY

Period: 24 months from time of shipment to end customer. Warranty Coverage: parts and labor for manufacturer defects. Accidental Damage: parts and labor repair of all parts. Replacement of all parts if beyond repair (complete Tool replacement requires deductible). Not Covered: Loss, theft, fire, neglect.

WARRANTY - \$1,500.00



MULTIWAVE GOGO BRACKET

The Gogo Bracket is used in place of the standard SmartAligner bracket for Gogo antennas. Attaches to the SmartAligner at the top of the Gogo antenna and fastens to the vertical plate. Comes complete with a tether line and clip. No extra tools required for attaching to the SmartAligner. Fits inside the accessory bay of the carrying case.

GOGOBRACKET - \$280.00



MULTIWAVE LASER AGL CABLE

The Multiwave Laser AGL Cable connects the Smart Aligner to TruPulse laser rangefinders. Allows vertical range distance to be imported to Smart Aligner. Sends information to smart phone app.

LASERAGLCABLE - \$100.00



TRUPULSE 200 LASER RANGEFINDER

Measures slope distance and inclination. Calculates horizontal distance, vertical distance, height, and 2D missing light. Distinguishes desired target from surrounding obstructions with closest, farthest, continuous, and filter modes. Accurate to +/- 8 in. to typical targets. Bluetooth connectivity to communicate with Antenna Alignment Tools. Mounts to tripods.

7005821 - \$849.99



RF VISION
antenna alignment tool

Maximize beamforming
antenna performance



5G READY ANTENNA ALIGNMENT



- Small Cell Compatible Antenna Alignment Tool
- Easy Alignment with Bullseye Targeting System
- Dual Frequency GNSS Technology for Fast & Accurate Readings
- Line-of-Sight Surveys to Identify Near-field Obstructions
- On-site Report Sharing through RF Vision Mobile App



Get 5G Ready with RF Vision!

3ZTELECOM.COM



3Z ANTENNA WASP SENSOR

The WASP is a Wireless Antenna Sensor Pod that when attached to an antenna, hourly monitors its alignment in 3 dimensions: azimuth, down-tilt, and roll. Will detect and report any undesired changes to all antennas being monitored. Allows network operators the ability to login to a specific communication facility and view the history of all changes. Features: high reliability, 10 + year battery life, ultra-low power consumption, +/- 0.5 tilt accuracy, weather proof packaging IP 67, no maintenance, and onsite and remote antenna monitoring.

3ZAW-1000A - \$99.95



3Z DATA COLLECTOR

The Data Collector forwards information that has been collected by the 3Z Antenna WASP. The information can be forwarded to wireless carriers, NOCC, operations staff, and RF engineers. The data collector is placed at the base of the tower or nearby communication facility in order to work in conjunction with the WASP.

3ZAW-1000D - \$499.95



3Z STRAP CLAMP

Designed to quickly mount the 3Z RF Aligner to a wide variety of antenna types. The double strap ratcheting system allows for secure fastening to panel antennas and drum antennas that range from 1' to 10'. 360° mounting capabilities as well. 2' diameter webbing straps included. Weighs 3 lbs, 16" x 8" x 6".

RFV-BRK-SC2F - \$499.95

RFV-WB06 6' Diameter webbing straps - \$24.95

RFV-WB10 10' Diameter webbing straps - \$49.95

RFV-WB12 12' Diameter webbing straps - \$74.95



3Z LIP CLAMP

The 3Z Lip Clamp was designed to quickly mount the RF Vision or 3Z RF Aligner to a wide variety of microwave parabolic dishes in all sizes. Equipped with an adjustable clamping system that was specifically designed to mount onto small and odd shaped microwave antennas. It is not only compact but also light weight and easy for you to use. Weighs 2 lbs, 10" x 6" x 4".

RFV-LIPC - \$499.99



3Z VISION ANTENNA ALIGNMENT TOOL

The 3Z RF Vision Antenna Alignment Tool replaces a compass, GPS, and range finder. This antenna alignment tool is effective and reliable to ensure that installers perform jobs as indicated on RF design specifications. Use the Vision Antenna Alignment Tool for accurate antenna alignment to prevent coverage gaps, network performance gradation, and loss of revenue. For the first time, an antenna alignment tool can not only align the antenna, but also show you where it is pointing with the built in HD camera. The camera provides a line of sight image that is mechanically aligned with the tool. The license to use this camera is optional and can be purchased for an additional fee (does not come included with the alignment tool). The 3Z RF Vision Antenna Alignment Tool is compatible with all the same accessories (besides the charger) as the 3Z RF Aligner Antenna Alignment Tool. Comes with an Rugged designed hard-case, universal strap clamp, soft-case bag, rubber bumpers, AC/DC power charger with 2-year Manufacturer Warranty. Only tool with 5" touch screen LED display. Impact resistant display. Weather resistant. Maximizes voice quality and data traffic. Improves data user throughput and KPI's. Reduces churn. Mechanically aligned with HD camera. Connects to multiple constellations. Multiple frequency technology.

RFV-2000 Aligner - \$6,995.00

RFV-2000-CAML With camera license - \$7,995.00

RFV-CAML Adding camera license after aligner date of purchase - \$1,300.00

3Z VISION 2-YEAR PHYSICAL DAMAGE PROTECTION PLAN

Physical Damage Protection Plan includes: Annual calibrations for the term life of the extended warranty (\$395.00 value per year). Annual battery replacement included for the term life of the extended warranty during annual calibration (\$150.00 value per year). Annual cleaning, and/or tune-ups during included recalibrations. Damage caused by accidental physical damage including unit dropped from buildings and towers. Damage caused by spilled liquids or accidental rain. Cosmetic defects or damage (such as cracked outer cases, cracked LCD screens) or defects that inhibit the proper operation and performance of the covered items. Electrical damage caused by improper or over-charging of battery or using incorrect voltage outlets or incorrect recharging adapters. Damage due to dust, animal or insect infestation. Repair or replacement due to vandalism, riot, or general environmental conditions, including but not limited to rust, corrosion or mold. Additional fees may apply.

3Z-RFV-DPP2 - \$1,790.00



3Z RF AIR32 ANTENNA BRACKET

1 lb 11 oz, 8.75" height, 5.7" width, 4.1" length. 360 degrees mounting capabilities. The AIR Mount was designed to be a light weight, precise and easy to use mounting solution for the AIR32 antenna. Allows for quick installation by utilizing ball bearings to spin mounting posts onto existing AIR bracket hardware.

RFV-EAIR Bracket - \$299.99

3ZRFA-SLCP Aluminum spring loaded clamp pin - \$19.99





SUNSIGHT ANTENNALIGN ALIGNMENT TOOL

Used during equipment installation or antenna position audits. Quick capture feature for on-site captures; Durable, weatherproof and rugged for tough conditions. Readings can be taken in seconds via any WIFI device, instantly creating a permanent record of an antenna alignment. Desired equipment position can be input prior to climb or entered into the tool on-site. Report records the final alignment specification, including latitude/longitude, azimuth, tilt, height, and current date/time, and also indicates its height above ground level.

AAT-30 - \$6,395.00

2110 Side mount bracket - \$450.00

2112 72" Extended side mount strap - \$50.00



SUNSIGHT MICROWAVE PATH ALIGNMENT

This new system can be used to quickly, simply and accurately to align point-to-point, short-haul and long-haul links. The system automatically calculates exact alignment requirements in real-time and provides the user simple targets for pathing the link. No additional software, post processing, or cables are required.

1008 Kit (2 MW08 aligners, 2 carrying cases, 2 tablets, 2 universal microwave mounts) - \$19,999.00

1015 Kit (2 MW15 aligners, 2 carrying cases, 2 tablets, 2 universal microwave mounts) - \$18,999.00

MW15 Single ended unit tool (1 MW15 aligner, 1 carrying case, 1 tablet, universal microwave mount) - \$9,999.00



SUNSIGHT LASER RANGEFINDER

Capture the above ground level (AGL) height within 1 foot (0.3 meters). This Rangefinder is used in place of a traditional tape drop and can be used with the Sunsignt AntennAlign Alignment Tool. Includes cable cord.

3301 - \$1,100.00



SUNSIGHT AIR ANTENNA MOUNT

10 lbs, 1.7" height, 3.8" width, 20" length. For use in conjunction with the AAT-30 or AAT-15 to Align Ericsson Air Antenna models, the Air11, Air21, or Air32. Required by Ericsson mandate for alignment of Air21 or 32 antennas when using Sunsignt Alignment Tool.

2100 - \$349.00

3 STEP EQUIPMENT FINANCING

1

PAY ADVANCE FINANCE PAYMENT

Pay 20% of the equipment cost as a down-payment. This is the first month's finance payment.
Example: \$5,000 equipment cost = \$1,000 (down-payment).

2

CALCULATE THE MONTHLY PAYMENT

Subtract the down-payment from the equipment cost. Then divide this by the 11 remaining months.
Example: \$5,000 equipment cost = \$1,000 (down-payment) = \$4,000/11 = \$363.64/month for 11 months.

3

BUY OUT FOR \$1.00

You will own the equipment at the end of the finance term for \$1.

Call or visit gmesupply.com for more info. \$75 application processing fee may apply. Financing only available for antenna aligners.



**NEW FEATURE
SPOTLIGHT**

Rugged design



With the upgraded FieldSENSE 2.0,
you're covered, no matter how dirty the job.

The new FieldSENSE 2.0 has a specially designed case which meets the rugged IP64 waterproof military standard for durability. It's made from the same material that riot shields are made of, so you don't have to worry about the device not keeping up with you. Plus it comes with a molded zipper case for storage and protection.



NEW **QUICK SHIP**

NARDA RADMAN 2 XT RF MONITOR

Wider frequency range extending up to 60 GHz, covers all services including 5G and millimeter waves. Built-in test now includes the sensor too for maximum safety. And it saves having to use an external test transmitter. Unmistakably loud alarm and extremely bright 270° wide angle light display. And if that's not enough, it vibrates as well. Patented Shaping displays the result directly in "% of limit value". No conversion, no settings to make, directly according to ICNIRP, FCC or Safety Code 6.

2281-102 - \$1,195.00



SUUNTO VISTA COMPASS

Features black azimuth scale division, reverse scale for taking cross bearings, optically magnified graduated scale and an index line, graduated 0-360° at 1° intervals, compass readings to 1/2° accuracy, housed in a lightweight, weatherproof ABS plastic that floats; includes lanyard, measures 2" W x 3" L x 5/8" D.

KB-20 - \$83.99

LEICA DISTO GEOSYSTEMS LASER DISTANCE METER

660' Range, easy and effortless outdoor distance measurement, unique combination of digital pointfinder and 360° tilt sensor allows measurements which are not possible with conventional distance meters, Bluetooth® Smart and attractive free app allow distances to instantly be transferred to iPhone or iPad for easy sketching, pointfinder with 4x zoom, IP65 water jet protection and dust tight, Smart Horizontal Mode™, height tracking, area/volume measurement, painter function, triangle/room angle, inclination tracking, Pythagoras functions, sloped object measurement, stake-out function, full functioning calculator, tripod thread for stable mounting, uses 2 AA 1.5 V batteries, 5.6" x 2.3" x 1.1".

E7500i - \$598.99



VIDEO

SUUNTO AZIMUTH COMPASS

Fast, accurate compass provides built-in precision and error-free operation; estimations can be made to 1/4°, housing is made of machined lightweight alloy; declination range is ±26° E / W (13° each way), accuracy ±0.5, optically magnified graduated scale, liquid-filled needle chamber, cotangent table, conversion table has cotangent 1°-45°, intervals of 1°; graduated 0°-360° in 1° increments, includes neck cord and case, measures 2" W x 3" L x 5/8" D.

KB-14/360RD - \$169.99



FIELDSENSE 2.0 PERSONAL RF SAFETY MONITOR

With this device, you're covered. The fieldSENSE 2.0 is the next generation in Personal RF Monitors. Specifically designed to protect personnel working near broadcast and telecommunications transmitting antennas from EMF/RF overexposure. The fieldSENSE 2.0 measures both E & H fields spanning from 50 MHz to 6 GHz. It covers all typical television and FM broadcast services and all mobile telecom services; shaped response, to more accurately measure exposure; isotropic design ensures the combination of all sources of radiation from all angles are correctly measured and assessed; data logging records all your measurements, and can be accessed via USB for evaluation after work is completed; fall-detect function will sound an alarm if a fall is detected to attract attention of other climbers; unique harness fastening system keeps device secure on the climber; IP64 enclosure uses the same polycarbonate used in riot shields, and rugged elastomer outer is made for tough environments; voice notes can be taken and listened to after work is completed; uses standard AAA batteries; water resistant; bright LEDs, visible in sunlight; single button operation; includes zipper case with molded foam insert.

FS2.0 - \$599.99



QUICK SHIP **VIDEO**

fieldSENSE
Personal RF Monitor





DEMAND
THE
BEST

SAFETY LMS

THE TOWER INDUSTRY'S #1 RESOURCE FOR TRAINING

OVER 25 ONSITE COURSES
& AN ONLINE LEARNING CENTER

safetylms.com | (512) 710-5000

For a complete offering of all courses available please visit our website at www.gmesupply.com. Pricing shown is open enrollment course pricing - please contact our Gear Experts® for group pricing at your location.



COMPETENT CLIMBER / RESCUER

Duration: One full day of classroom instruction and two full days of on-site instruction teaching basic and advanced tower rescue and climbing procedures.

Course description: This course is designed for climbers with 90+ days of tower experience. Throughout the 3 days of class, students will learn and demonstrate the skills needed to safely perform day to day tower work, while also having the necessary skills to perform multiple types of rescues in an emergency. The class can be fully customized to suit a company's needs, classes can be ran at one of the Safety LMS facilities across the US or at the companies private headquarters.

10001 - \$1,495.00



COMPETENT RIGGING PER ANSI 10.48 STANDARD

Duration: One full day classroom course.

Course description: This course details all aspects for the ASSE/ANSI 10.48-2016 Standard and is designed with specific emphasis on load calculations and rigging plans for antenna and line and structural modifications crews using a capstan hoist as the primary means of lifting loads with a line pull not exceeding 1,000 lbs. This course is intended for individuals who are experienced riggers, qualified persons or qualified engineers.

10002 - \$795.00



COMPETENT CLIMBER / RESCUER TRAIN THE TRAINER

Duration: One full day classroom course and two full days on-site practical instruction.

Course description: This course will allow qualified individuals to become certified to teach both Authorized Climber / Rescuer and Competent Climber / Rescuer in-house. A qualified individual has 5+ years of practical climbing experience and holds a current Competent Climber / Rescuer card. The company must also meet a set of basic requirements. Upon completion, trainers will be provided with a packet of course material and all of the tools to train their entire team.

10005 - \$3,695.00



COMPETENT RIGGING TRAIN THE TRAINER

Duration: One full day classroom course.

Course description: This course will allow qualified individuals to become certified to teach the Competent Rigging curriculum in-house to their companies employees. A qualified individual has 5+ years of climbing and/or rigging experience and holds a current Climber / Rescuer Certification. The company must also meet set of basic requirements. Upon completion, trainers will be provided with a packet of course material and all of the tools to train their entire team up to a Competent Rigging level.

10007 - \$2,895.00



CAPSTAN HOIST OPERATIONS

Duration: Half-day classroom course. Optional practical instruction available with additional cost.

Course description: This course covers the use of Capstan hoists on communications sites. There are several types and designs of Capstan hoists that will be covered in this class, along with their use and hazards associated with operating the various units. The intent of this course is to give each student the basic understanding to make good decisions while operating. This course combined with practical experience will help prevent accidents and create better operators. A certificate of completion will be issued upon successful completion of the written exam.

10003 - \$495.00



GIN POLE & TOWER ERECTION HOIST OPERATIONS

Duration: Full day classroom course. Recommended practical instruction with additional cost.

Course description: This course was designed to exceed the TIA-PN-4860 Gin Pole standard for "Design and Use" and NATE standard "Base Mounted Hoist Mechanism Design & Use Standard For Lifting Personnel While Working On Telecommunications Structures" as referenced by the OSHA Directive CPL-1.36. In this course the student will learn the design criteria of a gin pole, how the gin pole and hoist are used, design criteria for a base mounted hoist and maintenance.

10013 - \$1,590.00

The Safety LMS online courses offer convenience, without the need for a physical class session or travelling. Just login and take the course from anywhere on your own time. Offering courses in English and Spanish. More online courses to be added throughout the year.



GO TO WWW.GMESUPPLY.COM/TRAINING TO VIEW ENTIRE TRAINING SELECTION ONLINE



FUNDAMENTALS OF RF / EME RADIATION ONLINE COURSE

\$90.00 PER PERSON // GROUP RATES AVAILABLE

TOPICS INCLUDE: IONIZING VS NON-IONIZING RADIATION, CUMULATIVE VS NON-CUMULATIVE HEATING, MANAGING EXPOSURE, TIME AVERAGING, ANTENNAS, RF SUITS & MONITORS, SIGNAGE

12+ NEW ONLINE COURSES UNDER DEVELOPMENT

SAFETY LMS

THE TOWER INDUSTRY'S #1 RESOURCE FOR TRAINING

gmesupply.com/training | LM-10022

CAPSTAN HOIST OPERATIONS ONLINE COURSE

Duration: 1.5 hours, online course.

Course description: This course is intended to give each student the basics in understanding how to make good decisions while operating the Capstan Hoist. This course, combined with practical experience, will help prevent accidents and create better operators. The course is tailored towards the Hubbell / AB Chance 1000 lbs Series 90 Capstan Hoist but covers many different types and designs, their use, and the hazards associated with operating the various units. At the end of the online course, participants will take a test. After receiving a passing grade, participants will be issued a certification valid for 2 years.

10023 - \$90.00

CRANE SPOTTER / SIGNAL PERSON COURSE

Duration: 1.5 hours, online course.

Course description: The Safety LMS Crane Spotter/Signal Person course is intended to cover the responsibilities of a Crane Signal Person and a Crane Spotter Person. The student will be exposed to how a crane physically responds to each signal and some of the hazards that exist while a crane is in use. After completing this class, the student will have a basic understanding of their responsibilities and how their signals affect operations. A certificate of completion will be issued upon successful completion of the written exam. Students are then required to download and print off a practical assessment sheet that, with the help of a competent person, shows that they are able to demonstrate the hand signals correctly.

This certification will be valid for 2 years.

10031 - \$90.00

SITE SAFETY AUDITS / RISK ASSESSMENT

Safety LMS Site Audits and Risk Assessments are designed for companies wanting to improve their crew's safety programs, but don't have the manpower to get to all of their sites or understand how to evaluate the crew once they are on site. This program is highly customizable to each company's needs and is available for small single site jobs to audits covering an entire state.

During an audit, the Safety LMS team will ensure your crews have all the current certifications, their equipment is inspected and tasks are being performed to the required OSHA, ANSI & TIA standards. Safety LMS can also custom tailor an on site training program that can insure the crews get the proper hands-on training in difficult and complex tasks such as Tower Erection, Gin Pole Operations or Tower Guy Wire Plumb & Tensioning.

CALL FOR CUSTOM QUOTE

CUSTOMIZED SAFETY PLAN DEVELOPMENT

Do you want a safety program specifically designed for your business, or one of those canned safety plans that sits on your shelf? Too many safety plans do just that. Safety LMS believes that a strong safety program starts with a specifically designed plan that fits your company and the specific type of work you perform. If a safety plan is to keep your business safe, the safety plan must specifically address your business.

If your company is looking to take the next step, or even their first step in their safety policies, Safety LMS will be there throughout the entire process. As your one stop shop for training and safety, they are able to build individualized EH&S plans for companies. Plans vary from company to company and can be customized in scale from a total overhaul to just an audit of current plans.

CALL FOR CUSTOM QUOTE



STANDARDS INDEX

Nearly every piece of safety equipment is regulated, as are the safety practices on the job. The information below is simply a guide for what is referenced in each standard and chapter. The full standard provides very specific detail for all aspects of the standard. For more information, give our Gear Experts® a call!

ANSI 10.48 STANDARD (BEST PRACTICES AND USE)

The Criteria for Safety Practices for the Construction, Demolition, Modification and Maintenance of Communications structures in the USA.

- General considerations
- References
- Definitions
- Pre-job planning
- Job site conditions
- Fall protection
- Radio frequency/electromagnetic energy
- Base mounted hoist used for material lifting and personnel lifting
- Personnel lifting accessories and processes
- Rigging
- Gin poles and other lifting devices
- Climbing facilities and access
- Structural construction loading considerations
- Training program requirements
- Capstan hoist operation

THE Z359 FALL PROTECTION CODE

ANSI/ASSE Z359.0-2012

Definitions and Nomenclature Used for Fall Protection and Fall Arrest

ANSI/ASSE Z359.1-2007

Safety Requirements for Personal Fall Arrest Systems, Subsystems and Components

ANSI/ASSE Z359.2-2007

Minimum Requirements for a Comprehensive Managed Fall Protection Program

ANSI/ASSE Z359.3-2007

Safety Requirements for Positioning and Travel Restraint Systems

ANSI/ASSE Z359.4-2013

Safety Requirements for Assisted-Rescue and Self-Rescue Systems, Subsystems and Components

ANSI/ASSE Z359.6-2009

Specifications and Design Requirements for Active Fall Protection Systems

ANSI/ASSE Z359.7-2011

Qualification and Verification Testing of Fall Protection Products

ANSI/ASSE Z359.11-2014

Safety Requirements for Full Body Harnesses

ANSI/ASSE Z359.12-2009

Connecting Components for Personal Fall Arrest System

ANSI/ASSE Z359.13-2013

Personal Energy Absorbers and Energy Absorbing Lanyards

ANSI/ASSE Z359.14-2014

Safety Requirements for Self-Retracting Devices For Personal Fall Arrest and Rescue Systems

ANSI/ASSE Z359.15-2014

Safety Requirements for Single Anchor Lifelines and Fall Arresters for Personal Fall Arrest and Rescue Systems

ANSI/ISEA 121-2018 DROPPED OBJECTS STANDARD

This standard consists of design, testing, performance, and labeling requirements for tool tethering systems and containers used to transport and secure tools and equipment while working at heights.

CSA S37-13 ANTENNAS, TOWERS, & ANTENNA SUPPORTING STRUCTURES

1. Scope
2. Reference publications
3. Definitions and symbols

4. Design requirements

5. Loads

6. Analysis

7. Structural steel

8. Corrosion protection

9. Other structural materials

10. Guy assemblies

11. Foundations and anchorages

12. Tower and pole structure installation

13. Obstruction lighting

14. Bonding and grounding

15. Insulator and insulation

16. Ladders, safety devices, platforms and cages

TIA-222-G

(ENGINEERING STANDARD)

This Standard provides the requirements for the structural design and fabrication of new and the modification of existing structural antennas, antenna-supporting structures, mounts, structural components, guy assemblies, insulators and foundations.

ANSI/TIA-322

(ENGINEERING STANDARD)

Loading Criteria, Analysis, and Design Related to the Installation, Alteration and Maintenance of Communication Structures

FREE
DOWNLOAD

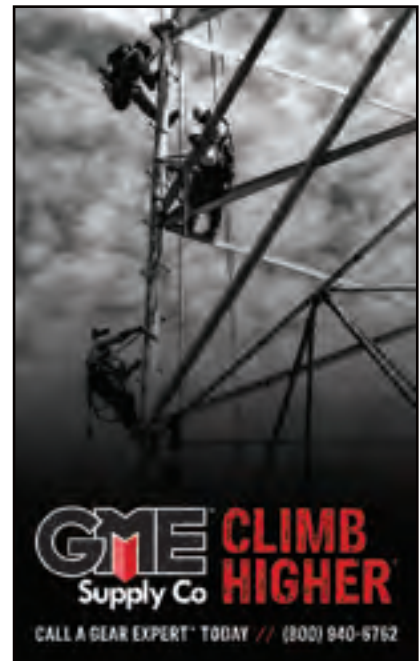

PELICAN ROPE

The Most Trusted Name In Rope®



STATIC MASTER PRO™ REVOLUTIONIZING THE WAY YOU CLIMB

Our new Static Master Pro is a static kernmantle rope with a polyester core and cover. Because of its 100% polyester composition, this rope has very low stretch yet is high strength. It is also very flexible and can be tied into tight knots and pass over pulleys and sheaves smoothly.

- Extremely Low Stretch
- Built to Withstand Rugged Outdoor Conditions
- High Strength
- High Flexibility



COLOR OPTIONS



WWW.PELICANROPE.COM



FROM THE COVER

Elk River Raven Tower Harness *pg 11*, Petzl Grillon Adjustable Rope Positioning Lanyard *pg 33*, WestFall Pro Separator Snaphook *pg 51*, Elk River Canvas Bolt Bag *pg 115*.

THIS PAGE

LEFT: DBI Sala Exofit Tower Climbing Harness *pg 15*, FallTech ElasTech Twin Leg Shock Absorbing Lanyard *pg 30*, DBI Sala Wire Cable Safety Sleeve *pg 81*, Petzl Vertex Vent Helmet *pg 123*, Bouton Safety Glasses *pg 130-133*. MIDDLE: MSA V-Gard Full Brim Hard Hat *pg 121*, Bolle Safety Glasses *pg 132-133*.

RIGHT: DBI Sala Exofit XP Tower Climbing Harness *pg 15*, FallTech ElasTech Twin Leg Shock Absorbing Lanyard *pg 30*, Petzl Grillon Adjustable Rope Positioning Lanyard *pg 33*, WestFall Pro Separator Snaphook *pg 51* DBI Sala Wire Cable Safety Sleeve *pg 81*, Petzl Vertex Vent Helmet *pg 123*, Bolle Safety Glasses *pg 132-133*, Ergodyne Knee Pads *pg 146*.

FEATURED BRANDS

3Z.....	201
Anritsu	195
Elk River.....	10
Ergodyne.....	183
FieldSENSE	204
FrenchCreek	21
Hubbell	82
Kenwood.....	191
Multiwave Sensors	198
NATE	6
Pelican Rope.....	210

Petzl.....	19
PMI.....	127
Rock Exotica	87
Safety LMS	206
Skylotec.....	26
Sterling Rope	72
WestFall Pro.....	12

KNOWLEDGE INDEX

6 ft vs 12 ft Free Fall.....	27
ABCD's of Fall Protection	9
ASME B30 Rigging Standard	85
Connectors 101	49

Fall Clearances 101	37
Full Body Harness 101.....	8
Respirators 101	139
Rope 101	54
Rope 201	55
Safety Helmets 101	122
SRL, SRD, PFL 101	36
Standards Index.....	209
Suspension Trauma 101	25
What's New.....	7

View all of our knowledge content online at www.gmesupply.com/learn



GME Supply Co
 1391 E. Boone Industrial Blvd.
 Columbia, MO 65202



♥ **429 Likes** 51w
 ● **gmesupply** #ClimbHigher-gram from @the_tower_tech. From this height the views don't get much better. #views #towerclimber #telecom #towertech



♥ **179 Likes** 45w
 ● **gmesupply** #ClimbHigher-gram from @tower_dog92. #towerclimbing #towerdog #towerclimber #telecom #tieofforflyoff #justgonnasendit



♥ **292 Likes** 48w
 ● **gmesupply** #ClimbHigher-gram from @coldsnapowers. #TowerClimbing takes us to some pretty unique locations. #towerclimber #towertech

▶ TAG YOUR PHOTOS WITH #CLIMBHIGHER ON [Instagram](#) AND [twitter](#) TO BE FEATURED HERE AND IN OUR WEEKLY MAILER!

INTERACT WITH US ON



www.gmesupply.com
 (800) 940-6762



Corporate Office:
 1391 E. Boone Industrial Blvd., Columbia, MO 65202

Branch Locations:
 Atlanta, Columbia, Corona, Dallas



\$ 1.99