

CLIMB HIGHER

PRODUCT CATALOG VOLUME 17.2

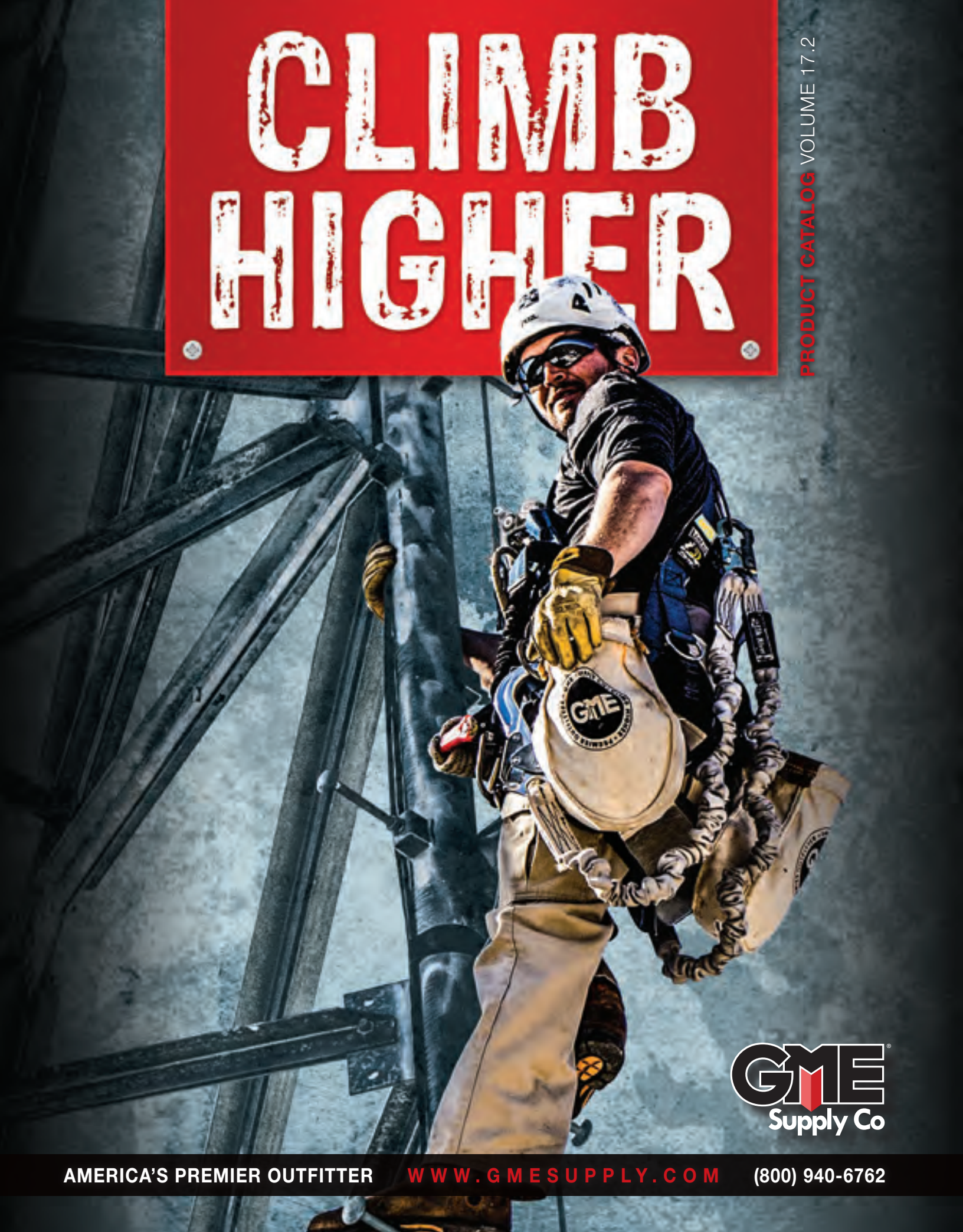

AMERICA'S PREMIER OUTFITTER

WWW.GMESUPPLY.COM

(800) 940-6762

WHY DO YOU CLIMB?

Up on the tower, it doesn't matter how bad of a day I'm having or what kind of mood I'm in. When I see the world from up there, everything changes. Nothing beats the way I feel when I get to the top and can see for miles.
- #RealTowerClimber





10% Discount
for exhibit space secured
by **July 1, 2017!**

Make Your Plans Today!

FEBRUARY 19-22

Gaylord Opryland Resort & Convention Center

www.natehome.com





PROUD SUPPORTERS OF



WELCOME:

GME Supply Company is a worldwide distributor and supplier of contractor equipment and industrial supplies for tower and steel erection, oil and gas, wind energy, roofing, maintenance, and more. We distribute a complete line of hard-to-find industrial supplies, PPE, fall protection safety equipment, rigging, professional tools, and related products for commercial and industrial applications.

Our staff are Gear Experts®. We combine industry knowledge with professional experience that allows us to understand the specialized needs of your company and provide custom solutions. "Climb Higher"® with GME Supply Company, your trusted resource for expert advice and superior service.

INFORMATION:

Phone: (718) 210-3913 // (800) 940-6762

Fax: (888) 511-0457

Website: gmesupply.com

Distribution Warehouses:

AL, CA, GA, IL, IA, KY, MN, MO, NE, NV, NY, TX, UT

Corporate Office:

1391 E. Boone Industrial Blvd.
Columbia, MO 65202

Hours:

7am-7pm, Mon-Fri
8am-1pm, Sat (CST)

Atlanta Branch:

4720 Robinson Drive SW
Atlanta, GA 30336

Hours:

8am-6pm, Mon-Fri (EST)



NOTICE: GME Supply Co. logo, "Climb Higher", and "Gear Experts" are registered trademarks of GME Supply Co. and are protected in the United States and abroad. All other trademarks contained within are the property of their respective owners. We are not responsible for typographical or photographic errors. Prices are subject to change without notice.
© 2017 GME Supply Co. All rights reserved.

HARNESSES 6-31

LANYARDS 32-52

ANCHORAGE 53-57

CARABINERS & HARDWARE 58-61

ROPE & RESCUE 62-89

LIFTING & RIGGING 90-102

INDUSTRY 103-106

CONFINED SPACE 107-109

BAGS & BUCKETS 110-119

PERSONAL SAFETY 120-143

APPAREL 144-154

TRAFFIC SAFETY & SIGNAGE 155-160

GROUNDING 161-162

INDUSTRIAL SUPPLIES 163-171

TOOLS 172-191

DEVICES 192-202

TRAINING & GME INDEX 203-212

FULL BODY HARNESS 101

DONNING THE HARNESS

1 UNTANGLE AND VISUALLY CHECK HARNESS
Grab the harness by the dorsal D-ring and follow the chest strap to untangle. Closely look over the harness webbing for abrasion, the hardware for excessive wear, and the impact indicators to ensure it hasn't been in a fall.

2 DON THE HARNESS
Put your arms through the shoulder straps, like a jacket. Don't secure the chest strap yet.

3 ADJUST FROM THE BOTTOM UP
The sub pelvic strap should rest just below your buttocks. Raise or lower this using torso adjusters, usually above the waist belt.

4 CONNECT & ADJUST LEG STRAPS
These should be snug, but not overly tight. You should be able to slide 2 or 3 fingers between your leg and the strap.

5 CONNECT & ADJUST CHEST STRAP & WAIST BELT
Waist belt should be snug, but not too tight or too loose. The chest strap should rest directly across your chest cavity. Not too high, not too low, but right in the sweet spot to keep you safe.

TYPES OF CONNECTORS

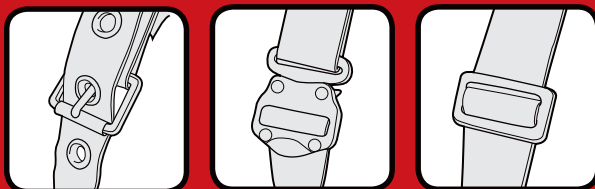

- TONGUE BUCKLES**
Easy operation, cannot slip once in position.
- QUICK-CONNECT**
Easiest operation, but can occasionally require readjustment.
- PASS-THRU/MATING**
Cheapest options, hardest to use and adjust properly.

INSPECTING THE HARNESS

Visually inspect these key areas of the harness every time, prior to beginning work. If you find any of these problems, take the harness out of service.

- WEBBING**
Cuts, tears, excess abrasion, holes, discoloration, UV damage, heat damage, welding slag, chemical damage, hard spots
- STITCHING**
Damaged stitching, broken thread, pulls and loose stitches, missing sections
- D-RINGS, HARDWARE, & BUCKLES**
Deformity, corrosion and rust, major nicks and dings, excess wear, proper operation
- IMPACT INDICATORS**
Deployed impact indicators, broken D-ring plates, deformed grommets
- LABELS**
Manufacturer, date of manufacture, inspection log, model, series, warnings

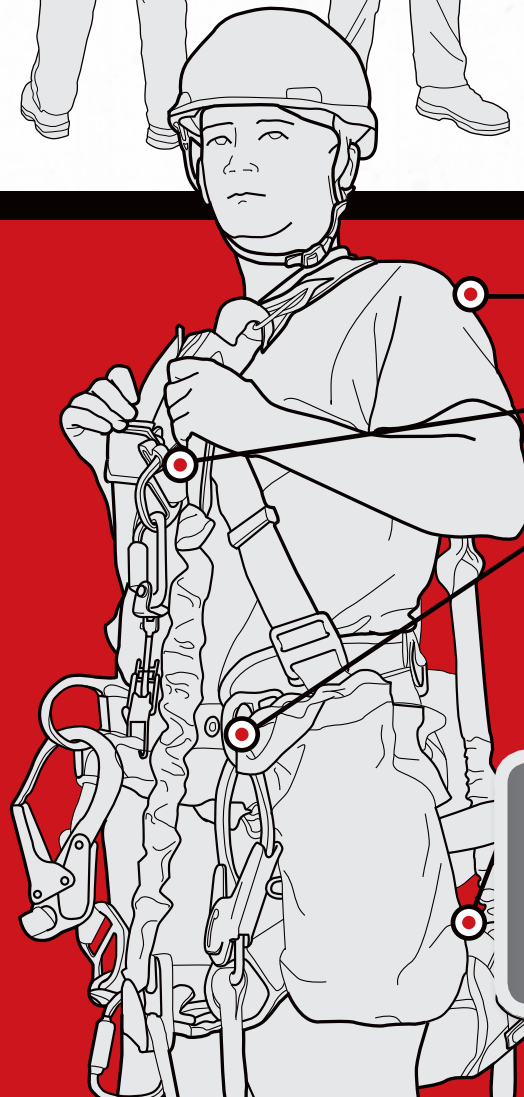

DORSAL CONNECTION
This D-Ring is found on all ANSI harnesses. It's used for fall arrest and should be placed directly between the shoulder blades.

CHEST STRAP
Tower harnesses have another D-Ring here. It's the only other connection point which can be used for fall arrest, like on a cable climb system. Unlike the Dorsal D, fall distance must be limited to 2 feet or less.

WORK POSITIONING
Side D-rings are used for work positioning. Never fall arrest.

SEAT SLING
A seat is a common feature on tower harnesses, and if you're working in suspension, you'll be glad you have one. Look for features like additional tool loops or aluminum reinforcement. D-Rings can be connected using a spreader bar.

VIDEO

PURCHASE THE
19" x 27" POSTER FOR
\$14.95
PART # 2201

ABCDs OF FALL PROTECTION

A typical fall arrest system has three main components, often described as the ABCD's of fall protection.

Anchorage. Body Support. Connectors. Descent & Rescue.

When used properly together, they provide the maximum degree of safety for a worker at height. But don't forget, a rescue plan is an equally important factor when it comes to fall protection. The proper gear for descent and rescue should always be a part of a complete fall protection plan, too.

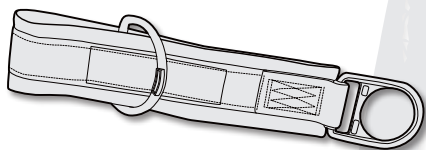

ANCHORAGE

Anchors provide secure attachment points for workers. There are many different ways to properly anchor depending on the industry, job, and structure. If you're on a tower, an anchorage point could be a tie-off sling, or perhaps an I-Beam anchor could be used in a horizontal system. Look for anchorage points rated for at least 5,000 pounds or even an engineered solution designed for your specific application. See the variety of anchorage options available starting on [page 53](#).

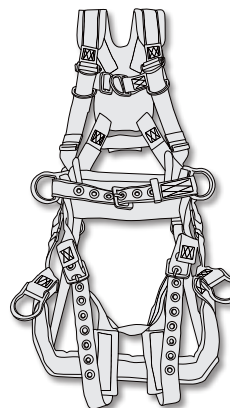

BODY SUPPORT

Now we're talking harnesses. There's no safe and natural way to attach one's body to a structure. Luckily, harnesses are designed to distribute the forces that occur in a fall to limit injuries, or worse, death. There are many varieties of harnesses available for different industries and jobs. Find the correct one for your application starting on [page 6](#).



CONNECTORS

Once you've chosen a comfortable harness and your anchor point is secure, you just need one last thing before you're ready to climb. Here's where a shock absorbing lanyard or SRL comes in. Twin-leg lanyards provide 100% tie-off. SRL's can limit your fall distance to a few inches. Again, there are a variety of connectors to choose from, made by many different manufacturers. See them all beginning on [page 32](#).

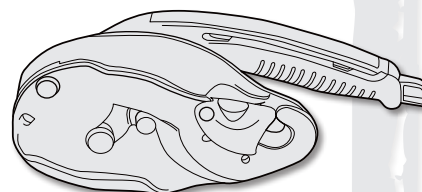

DESCENT & RESCUE

What's your plan? Every job site needs to have proper rescue equipment and a proper rescue plan in place before anyone starts working. From rope access to confined space, there is specific gear needed to get to a fallen worker and get them to safety. A haul system helps raise them up, and a descent device will lower them down. Or maybe you could add trauma straps to your harness, so if you're the one dangling you can relieve some of the pressure that gravity is placing on your parts. Lucky for you, our Gear Experts® have put together some rescue kits that can get you started on your rescue solution. Take a look starting on [page 62](#).

SIZING
CHART
ONLINE

CUSTOMER
CHOICE

VIDEO



**DBI SALA
EXOFIT
NEX TOWER
CLIMBING
HARNESS**

Quick-connect chest and leg straps; tongue buckle waist belt; aluminum front, back and side D-rings; sewn-in hip pad and belt; removable seat sling with positioning D-rings.

1113190 S - \$534.99

1113191 M - \$534.99

1113192 L - \$534.99

1113193 XL - \$534.99



**DBI SALA
EXOFIT TOWER
CLIMBING
HARNESS**

Quick-connect chest and leg straps; tongue buckle waist belt; aluminum front, back and side D-rings; removable seat sling with positioning D-rings.

1108650 S - \$409.99

1108651 M - \$409.99

1108652 L - \$409.99

1108657 XL - \$409.99

Tongue buckle leg straps

1110525 S - \$506.99

1110526 M - \$506.99

1110527 L - \$506.99

1110528 XL - \$506.99

1110529 2XL - \$506.99



VIDEO



**DBI SALA
EXOFIT XP
TOWER
CLIMBING
HARNESS**

Quick-connect chest and leg straps; tongue buckle waist belt; aluminum front, back and side D-rings; belt with back pad and side D-rings; removable seat sling with positioning D-rings.

1110300 S - \$428.99

1110301 M - \$428.99

1110302 L - \$428.99

1110303 XL - \$428.99

VIDEO



**DBI SALA
EXOFIT
NEX TOWER
CLIMBING
HARNESS**

Custom designed with tongue buckle leg straps and waist belt; quick-connect chest straps; aluminum front, back and side D-rings; sewn-in hip pad and belt; removable seat sling with positioning D-rings.

1113375 S - \$602.99

1113376 M - \$602.99

1113377 L - \$602.99

1113378 XL - \$602.99

VIDEO



**MILLER AIRCORE
TOWER CLIMBING
HARNESS**

Quick-connect chest and leg straps, front D-ring, lumbar pad, side D-rings, up to 21% lighter than similar competitive harnesses, leather Bos'n chair attachment, removable belt with tool loops.

ACT-QCBCUG

S/M - \$607.99

Universal - \$607.99

Aluminum hardware

S/M - \$675.99

Universal - \$675.99

ELK RIVER PEREGRINE PLATINUM TOWER CLIMBING HARNESS

70° aluminum D-ring on back, (2) aluminum D-rings on hips and seat strap, steel D-ring on chest, quick-connect chest and leg straps, breathable padding, lanyard parks, fall indicators, removable tool belt, removable aluminum bar in seat, carry-all bag.

- 67601 S - \$362.99
- 67602 M - \$362.99
- 67603 L - \$362.99
- 67604 XL - \$362.99



ELK RIVER PEREGRINE RAS PLATINUM TOWER CLIMBING HARNESS

Adjustable and detachable seat, removable aluminum bar in seat, 70° aluminum D-ring on back, (2) aluminum D-rings on hips and seat strap, steel D-ring on chest, quick-connect chest and seat, tongue buckle leg straps with extra grommets for improved fit adjustment, breathable padding, lanyard parks, fall indicators, removable tool belt, carry-all bag.

- 67631 S - \$452.99
- 67632 M - \$452.99
- 67633 L - \$452.99
- 67634 XL - \$452.99



ELK RIVER PEREGRINE PLATINUM TOWER CLIMBING HARNESS

70° aluminum D-ring on back, (2) aluminum D-rings on hips and seat strap, steel D-ring on chest, quick-connect chest strap, tongue buckle leg straps, breathable padding, lanyard parks, fall indicators, removable tool belt, removable aluminum bar in seat, carry-all bag.

- 67611 S - \$362.99
- 67612 M - \$362.99
- 67613 L - \$362.99
- 67614 XL - \$362.99

Steel D-rings

- 67641 S - \$371.99
- 67642 M - \$371.99
- 67643 L - \$371.99
- 67644 XL - \$371.99

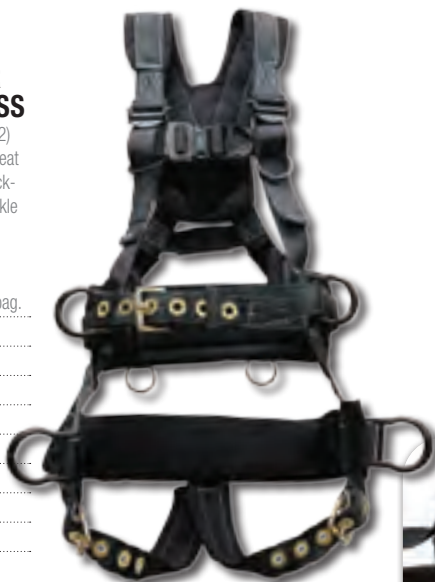

FALLTECH COMFORTECH TOWER CLIMBING HARNESS

(6) D-rings, removable saddle seat with padding and 5-point adjustability, ComforTech waist, shoulder and leg pads, tongue buckle belt and leg adjustments, quick-connect chest strap.

- 7084S S - \$430.99
- 7084M M - \$430.99
- 7084L L - \$430.99
- 7084XL XL - \$430.99



FRENCH CREEK 800 SERIES TOWER CLIMBING HARNESS

(6) D-rings located on back, hips, chest, and seat; adjustable shoulder, chest, waist, and leg straps; removable tool belt, shoulder pads, 6" back pad, removable seat.

- 850ABTH S/M - \$139.99
- 850ABTH L/XL - \$139.99



ELK RIVER EAGLETOWER LE HARNESS

(6) steel D-rings located on back, chest, hips, and seat strap; lanyard parks, shoulder pads, quick-connect chest strap, tongue buckle leg straps, removable tool belt with padding.

- 66611 S - \$244.99
- 66612 M - \$244.99
- 66613 L - \$244.99
- 66614 XL - \$244.99
- LX - Aluminum bar in seat
- 66621 S - \$267.99
- 66622 M - \$267.99
- 66623 L - \$267.99
- 66624 XL - \$267.99



SIZING CHART ONLINE

ALUMINUM HARDWARE



WESTFALL PRO ASCEND TOWER CLIMBING HARNES

Built from the seat out by tower climbers, sleek black webbing with silver stitching; lightweight, aluminum front, back and side D-rings for reduced overall weight; locking quick-connect chest buckle; sewn-in hip pad with removable tool belt; breathable back and shoulder padding for increased comfort; large, adjustable seat for easy positioning and all day comfort; extra utility attachment loops on seat and belt provide secure points for hardware, tool lanyards and more; fall indicators for safety inspection; easily accessible lanyard parks.

- 88021 S - \$409.99
- 88022 M - \$409.99
- 88023 L - \$409.99
- 88024 XL - \$409.99

CUSTOMER CHOICE

VIDEO

STEEL HARDWARE

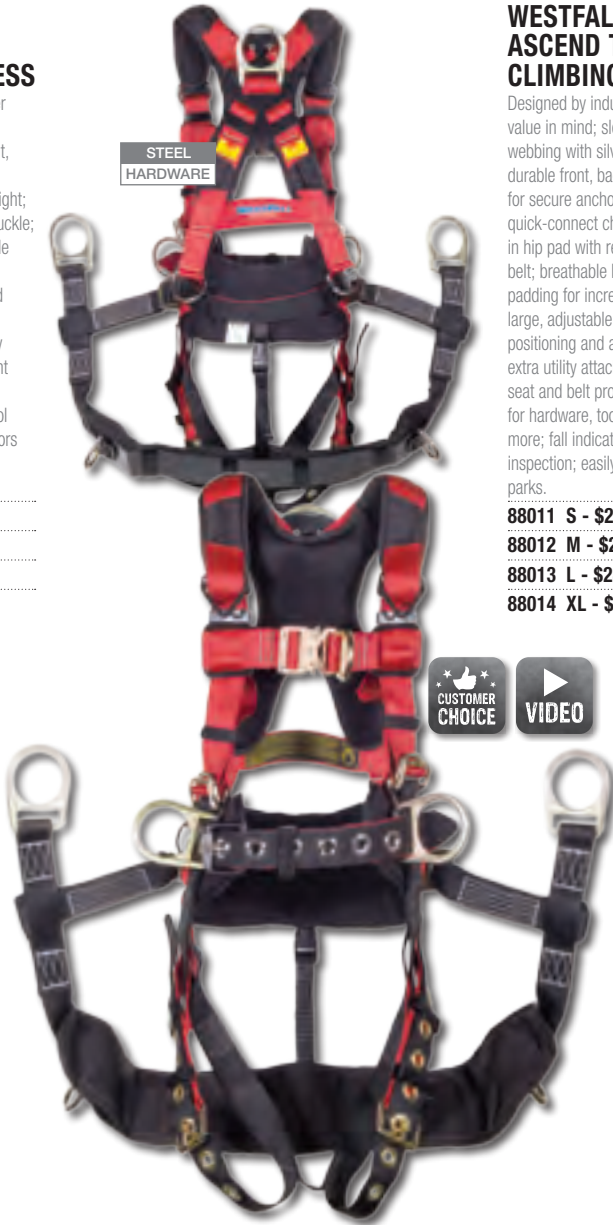

WESTFALL PRO ASCEND TOWER CLIMBING HARNES

Designed by industry experts with value in mind; sleek red and black webbing with silver stitching; durable front, back and side D-rings for secure anchorage; locking quick-connect chest buckle, sewn-in hip pad with removable tool belt; breathable back and shoulder padding for increased comfort; large, adjustable seat for easy positioning and all day comfort; extra utility attachment loops on seat and belt provide secure points for hardware, tool lanyards and more; fall indicators for safety inspection; easily accessible lanyard parks.

- 88011 S - \$249.99
- 88012 M - \$249.99
- 88013 L - \$249.99
- 88014 XL - \$249.99

CUSTOMER CHOICE

VIDEO



NEW

SKYLOVEC PROTON TOWER HARNES

(6) D-rings located on back chest hips and seat; features airpad technology, removable quick-connect waist belt, gear loops, and removable padded seat.

- G-1132-T
- XS-M - \$595.00
- M-2XL - \$595.00
- 2XL-5XL - \$654.50



SKYLOVEC TOWER TEC HARNES

(6) D-rings located on back, chest, hips, and seat; 6-point adjustment, padded shoulder, hip, and leg areas; removable padded seat, aluminum quick-connects on chest and legs, removable tool belt.

- G-1082
- S/M - \$349.99
- L/XL - \$349.99



FRENCH CREEK STRATOS TOWER CLIMBING HARNES

(6) D-rings, 6-point adjustment, removable tool belt, tongue buckle legs; shoulder, back and leg pads, breathable mesh with moisture control; lightweight, removable seat.

- 22850BH-ALT
- S/M - \$249.99
- L/XL - \$249.99

SIZING
CHART
ONLINE

**DBI SALA EXOFIT
STRATA TOWER
CLIMBING HARNESS**

LiFTech weight distribution system, PolarMesh back pad, EZ-Link SRL adapter, Tri-Lock revolver quick-connect buckles, Stand-up Tech-Lite aluminum dorsal D-ring, Body belt/hip pad with thermoformed EVA padding and Tech-Lite aluminum side D-rings, Snap and Go Tech-Lite aluminum front D-ring, adjustable, removable seat sling with aluminum board and Tech-Lite aluminum positioning D-rings, Repel webbing, built-in lanyard keepers that automatically reset, Revolver vertical torso adjusters, integrated trauma straps, customizable name tag, equipped with i-Safe.

1112580 S - \$698.99

1112581 M - \$698.99

1112582 L - \$698.99

1112583 XL - \$698.99

1112584 2XL - \$738.99

Tongue & buckle leg straps

1112585 S - \$673.99

1112586 M - \$673.99

1112587 L - \$673.99

1112588 XL - \$673.99

1112589 2XL - \$713.99



**PETZL VOLT TOWER LT
CLIMBING HARNESS**

Features an EasyFit design that ensures the harness will keep its shape, fast buckles on waist belt and legs allow quick harness adjustment, seat is included and is attached directly to the harness for work positioning, provides comfort and relief for tower climbing applications during extended periods of suspension, dorsal side D-rings and sternal attachment points, ladder climb attachment point, extra wide waist belt for extra support and comfort.

C72SFA-0U Size 0 - \$454.95

C72SFA-1U Size 1 - \$454.95

C72SFA-2U Size 2 - \$454.95



**FALLTECH
FLOWTECH TOWER
CLIMBER HARNESS**

(6) aluminum D-rings located on back, chest, hips, and seat; FlowScape yoke and waist pads, quick-connect chest and tongue buckle legs with connection covers, aluminum reinforced padded seat, integrated tool keepers on waist and seat, lightweight ergonomic design.

8092BS S - \$479.99

8092BM M - \$479.99

8092BL L - \$474.99

8092BXL XL - \$479.99

Quick-Connect Leg Straps.

8092AS S - \$479.99

8092AM M - \$479.99

8092AL L - \$479.99

8092AXL XL - \$479.99



**SAFEWAZE TOWER
HARNESS WITH SEAT**

(6) aluminum D-rings located on back, chest, hips, and seat; quick-connect buckles; crock backrest ergonomically designed to improve comfort and support; top portion of harness can be removed for climbing belt configuration; comfortable and versatile seat.

FS227-T

S/M - \$431.99

L/XL - \$431.99

2XL - \$431.99





DBI SALA EXOFIT NEX ARC FLASH TOWER CLIMBING HARNESS

PVC coated aluminum back and front D-rings; belt with pad and PVC coated aluminum side D-rings; seat sling with PVC coated suspension D-rings, Nomex/Kevlar fiber webbing and comfort padding; locking quick-connect buckle leg straps; Revolver vertical torso adjusters; built-in lanyard keepers; Arc flash rated.

- 1113357 S - \$1,234.99
- 1113358 M - \$1,234.99
- 1113368 L - \$1,234.99
- 1113369 XL - \$1,234.99



ELK RIVER FIREMASTER KEVLAR WEB ASSEMBLY

Web assembly with rebar hook center / snaphook ends; use for positioning; heat resistant; made of Kevlar; 14" length, 1-3/4" width; 3,600 lb gate. 95740 - \$70.00

ELK RIVER KEVLAR TIE-OFF ADAPTER

Steel pass-thru tie-off adapter.
 95903 3' - \$60.99
 95904 4' - \$72.99
 95906 6' - \$94.99
 95908 8' - \$99.99
 95910 10' - \$105.99



WESTFALL PRO WELDING TOWER CLIMBING HARNESS

Flame resistant Nomex/Kevlar webbing and padding for high-heat and welding applications; durable, steel front, back and side D-rings; locking quick-connect chest buckle; sewn-in hip pad with removable tool belt; large, adjustable seat; extra utility attachment loops on seat and belt; fall indicators; lanyard parks.

- 88031 S - \$678.99
- 88032 M - \$678.99
- 88033 L - \$678.99
- 88034 XL - \$678.99



FALLTECH WELDTECH HARNESS SLAG SHIELD

Suede leather outer shell, with polyester lining; protects upper torso harness webbing from burns caused by welding spatter.

5075A - \$33.99



DBI SALA SHOCKWAVE2 ARC FLASH 100% TIE-OFF SHOCK ABSORBING LANYARD

6' double-leg with elastic Nomex/Kevlar fiber webbing and snaphook center / aluminum rebar hook ends.

1244632 - \$343.99

FALLTECH LANYARD SLAG SHIELD

Suede leather outer shell with polyester lining for 6' single-leg lanyards; protects lanyard webbing from burns caused by welding spatter.

5075C - \$25.99

FALL PROTECTION ESSENTIALS

Peregrine RAS Platinum Tower Climbing Harness

Elk River has been an innovator of tower products for many years. The lightweight Peregrine RAS features an adjustable and removable aluminum bar seat. It's known as one of the most comfortable harnesses on the market, due to its aluminum D-rings and breathable padding. It's versatile with multiple tool rings and extra grommets on belt and leg straps for perfect fit.

Flex-NoPac Shock Absorbing Lanyard

This twin leg lanyard features 6' legs with a 2-1/4" double-locking rebar hook at each end and a 3/4" centurion auto-lock snaphook in the middle. This lanyard is one of the most popular lanyards in the industry.

 **Elk River**
Personal Fall Protection

PERFORMANCE-DESIGNED SAFETY PRODUCTS

WWW.ELKRIVER.COM



KITS
SAVE
CASH



GME SUPPLY WESTFALL PRO TOWER CLIMBING KIT

Kit includes WestFall Pro Ascend Steel Tower Climbing Harness, WestFall Pro 6' Shock Absorbing Twin Leg Lanyard, Petzl Vertex Vent Helmet, Petzl Grillon Positioning Lanyard, WestFall Pro Separator Snaphook, DBI Sala 3/8" Cable Safety Sleeve with Carabiner, (2) 4-1/2" x 2-3/4" Steel Carabiners, (2) 4-7/8" x 3" Steel Carabiners, (2) GME Supply Top-Closing Bull-Pin and Bolt Bags. Helmet color options: white, red, yellow, blue, black, orange, and hi-viz yellow.

Upgrades available: Aluminum Hardware on Harness (+\$75.00), GME Supply Deluxe Gear Bag (+\$55.00).

90007 - \$1027.99

CUSTOMER
CHOICE



GME SUPPLY EXOFIT TOWER CLIMBING KIT

Kit includes DBI Sala ExoFit Tower Climbing Harness, Elk River 6' Shock Absorbing Twin Leg Lanyard, Petzl Vertex Vent Helmet, Petzl Grillon Positioning Lanyard, WestFall Pro Separator Snaphook, DBI Sala 3/8" Cable Safety Sleeve with Carabiner, (2) 4-1/2" x 2-3/4" Steel Carabiners, (2) 4-7/8" x 3" Steel Carabiners, (2) GME Supply Top-Closing Bull-Pin and Bolt Bags. Helmet color options: white, red, yellow, blue, black, orange, and hi-viz yellow.

Upgrades available: GME Supply Deluxe Gear Bag (+\$55.00).

90006 - \$1,247.99

NEW



CSA TOWER CLIMBING KIT

Kit includes Elk River Peregrine Platinum Tower Climbing Harness, Skylotec Skysafe Proflex Steel Lanyard, Petzl Vertex Vent Helmet, GME Supply Deluxe Gear Bag, WestFall Pro Separator Snaphook, (2) 4-7/8" x 3" Steel Carabiners, (2) 4-1/2" x 2-3/4" Steel Carabiners, GME Supply 3/8" Cable Safety Sleeve with Carabiner. Helmet color options: white, red, yellow, blue, black, orange, and hi-viz yellow.

Upgrades available: Miller Aircore Aluminum Tower Climbing Harness (+\$250.00), Skylotec Ignite Proton Tower Harness (+\$175.00), Skylotec Skysafe Proflex Aluminum Lanyard (+\$25.00), Kask Zenith Helmet (+\$10.00), Miller Vi-Go (+\$255.00), Elk River Positioning Lanyard (+\$45.00), Petzl Grillon Positioning Lanyard (+\$175.00).

90018 - \$949.99

VIDEO



GME SUPPLY EXOFIT NEX TOWER CLIMBING KIT

Kit includes DBI Sala ExoFit NEX Tower Climbing Harness, Petzl Grillon Positioning Lanyard, Elk River 6' Shock Absorbing Twin Leg Lanyard, GME Supply Top Closing Bull-Pin and Bolt Bag, WestFall Pro Separator Snaphook, (2) 4-7/8" x 3" Steel Carabiners, 9" x 5-1/2" Steel Carabiner.

Upgrades available: Petzl Vertex Vent Helmet (+\$115.00), EVO 6151 Vent Helmet (+\$45.00), GME Supply Deluxe Gear Bag (+\$55.00), DBI Sala 3/8" Cable Safety Sleeve with Carabiner (+\$370.00).

90005 - \$942.99

**KITS
SAVE
CASH**



GME SUPPLY COMPLETE TOWER CLIMBING KIT

Kit includes Elk River EagleTower LE Tower Climbing Harness, Safety Helmet, 3/8" Wire Rope Grab with Carabiner, Elk River 6' Adjustable Web Lanyard, Elk River 6' Shock Absorbing Twin Leg Lanyard, WestFall Pro Separator Snaphook, (2) 4" x 2" Steel Carabiners, (2) 7" x 3-3/4" Steel Carabiners, GME Supply Top-Closing Bull-Pin and Bolt Bag, GME Supply Deluxe Gear Bag.

Upgrades available: Petzl Vertex Vent Helmet (+\$99.00), EVO 6151 Vent Helmet (+\$35.00), DBI Sala 3/8" Cable Safety Sleeve with Carabiner (+\$220.00).

90002 - \$707.99



GME SUPPLY ESSENTIAL TOWER CLIMBING KIT

Kit includes French Creek 800 Series Tower Harness, Elk River 6' Shock Absorbing Twin Leg Lanyard, 3/8" Wire Rope Grab with Carabiner, (2) 4-7/8" x 3" Steel Carabiners, GME Supply Bull-Pin and Bolt Bag, WestFall Pro Separator Snaphook, Guardian Adjustable Positioning Web Lanyard, FallTech 3' Pass-Through Sling, Ergodyne Medium Duffel Bag.

Upgrades available: Petzl Vertex Vent Helmet (+\$115.00), EVO 6151 Vent Helmet (+\$45.00), DBI Sala 3/8" Cable Safety Sleeve with Carabiner (+\$220.00), GME Supply Top-Closing Bolt Bag (+\$10.00).

90010 - \$502.99



GME SUPPLY BASIC TOWER CLIMBING KIT

Kit includes Elk River EagleTower LE Tower Climbing Harness, Elk River 6' Shock Absorbing Twin Leg Lanyard, Guardian Adjustable Positioning Web Lanyard, WestFall Pro Separator Snaphook.

Upgrades available: Petzl Vertex Vent Helmet (+\$115.00), EVO 6151 Vent Helmet (+\$45.00), Construction Helmet (+\$8.75), GME Supply Deluxe Gear Bag (+\$55.00), GME Supply Top-Closing Bolt Bag (+\$23.00).

90000 - \$377.99



GME SUPPLY FALLTECH TOWER CLIMBING KIT

Kit includes FallTech Comfortech Tower Climbing Harness, Elk River 6' Shock Absorbing Twin Leg Lanyard, Guardian Adjustable Positioning Web Lanyard, WestFall Pro Separator Snaphook, GME Supply Top Closing Bull-Pin and Bolt Bag.

Upgrades available: Petzl Vertex Vent Helmet (+\$115.00), EVO 6151 Vent Helmet (+\$45.00), GME Supply Deluxe Gear Bag (+\$55.00), DBI Sala 3/8" Cable Safety Sleeve with Carabiner (+\$370.00).

90004 - \$512.99

BUILD YOUR OWN TOWER CLIMBING KIT

START WITH THE BASICS \$378.00

KITS
SAVE
CASH



Elk River EagleTower
LE Harness



Elk River Shock Absorbing
Flex NoPac Lanyard



Guardian Adjustable
Positioning Web Lanyard



JSP Comfort Plus Type 1
Hard Hat

CHOOSE YOUR DISCOUNTED UPGRADES (MORE OPTIONS ONLINE)



Elk River Peregrine Platinum
Tower Harness +\$120⁰⁰



WestFall Pro Ascend Tower
Harness (Aluminum) +\$149⁰⁰



DBI Sala ExoFit
Tower Harness +\$138⁰⁰



DBI Sala Strata Tower
Harness +\$500⁰⁰

CHOOSE YOUR PACKAGES



Bag Package: GME Supply Deluxe Gear Bag & (2) GME
Supply Heavy-Duty Top-Closing Bolt Bag +\$112⁰⁰



FallTech Aluminum Shock
Absorbing Lanyard +\$29⁰⁰



WestFall Pro Shock
Absorbing Lanyard +\$10⁰⁰



Kong Trimmer Adjustable 2 m
Positioning Lanyard +\$132⁰⁰



Petzl Grillon Adjustable 2 m
Positioning Lanyard +\$146⁰⁰



Connector Package: Separator Snaphook, (2) 4-7/8" x 3"
Steel Carabiners, & (2) 7" x 3-3/4" Steel Carabiners +\$118⁰⁰



Petzl Vertex Vent
Helmet +\$99⁰⁰



JSP Deluxe Wheel
Ratchet Helmet +\$37⁰⁰



DBI Sala Lad-Saf X3 Cable Safety
Sleeve with Carabiner +\$463⁰⁰



Miller Vi-Go Cable Grab with
Carabiner +\$402⁰⁰



Accessory Package: Elk River Radio Holster, (2)
Ergodyne Squids Tool Lanyards, & (2) FallTech 3'
Anchor Straps +\$69⁰⁰

AVAILABLE EXCLUSIVELY AT GME SUPPLY www.gmesupply.com | (800) 940-6762

www.gmesupply.com/build-a-kit | Part Number: 90099



GME SUPPLY CARRIES A COMPLETE SELECTION OF CSA RATED GEAR

For a larger selection, visit gmesupply.com

MILLER AIRCORE TOWER CLIMBING HARNESS

Quick-connect chest and leg straps, front D-ring, lumbar pad, side D-rings, up to 21% lighter than similar competitive harnesses, leather Bos'n chair attachment, removable belt with tool loops. CSA compliant.

AAT-QCBCUG

S/M - \$675.99

Universal - \$675.99

2XL/3XL - \$675.99



PETZL AVAO BOD CROLL FAST HARNESS

X-Shaped dorsal construction reduces pressure points during prolonged suspension, integrated croll ventral rope clamp for ascending ropes, aluminum D-Rings, waist belt and leg loops for positioning; fold-away side attachment points, (6) equipment loops on the sides and rear, (4) caritool tool holder retainers, (2) slots for tool bag tool pouch. CSA compliant

C71CFA1U Size 1 - \$484.95

C71CFA2U Size 2 - \$484.95

CROLL, black-out version

C71CFN1U Size 1 - \$499.95

C71CFN2U Size 2 - \$499.95



SKYLOTEC SKYSAFE PRO FLEX SHOCK ABSORBING LANYARD

Steel snaphook center / steel rebar hook ends, 6' length, designed for foot level tie-off, ANSI and CSA compliant.

L-0562-1,8 - \$219.99

PETZL ABSORBICA TIE-BACK SHOCK ABSORBING LANYARD

Intermediate tie-back rings, steel carabiner with triact-lock auto-locking system, compact energy absorber, elasticized arms to avoid hindering progression, ANSI and CSA compliant.

L64YUT-150 - \$349.95



PETZL VERTEX VENT

Ventilation holes with adjustable sliding shutters allow air to circulate in the helmet when needed, 6-point webbing suspension system conforms to the shape of the head for improved comfort, shock absorption is achieved through deformation of the outer shell, ANSI and CSA compliant. Available in white, red, orange, yellow, hi-viz green, blue, and black.

A10VWA - \$114.95



KASK ZENITH HELMET

High density ABS plastic outer shell, Polystyrene inner shell, PA soft nylon headband, external lamp clips, Fast3Dry fabric for quick absorption of moisture, ANSI and CSA compliant. Available in white, red, orange, pink, yellow, blue, black, hi-viz white, hi-viz yellow, hi-viz lime neon (hi-viz +\$10.00).

WHE00031 - \$129.95



MILLER VI-GO AUTOMATIC PASS-THROUGH CABLE SAFETY SLEEVE

For use with 5/16" or 3/8" diameter cable, automatically bypasses intermediate cable guides keeping both hands free for climbing, travels smoothly along cable and locks instantly in the event of a fall. CSA compliant.

VGCS With swivel carabiner - \$401.49

With carabiner - \$452.99



GME SUPPLY CABLE SAFETY SLEEVE

For use with 3/8" cable, comes with carabiner, works on both galvanized and stainless steel cables, meets ANSI, OSHA and CSA requirements for vertical lifelines.

RG-5000 - \$149.99



WESTFALL PRO STEEL CARABINER

4-7/8" length, 3-1/8" width, 1-1/16" gate opening, 45 kN MBS. All WestFall Pro carabiners are ANSI and CSA compliant.

07400- \$21.99



PETZL OK TRIACT LOCK ALUMINUM CARABINER

3.9" length, 2.8" width, 0.75" gate opening, 24 kN MBS. All Petzl carabiners are CSA compliant.

M33-TL - \$23.95



SIZING CHART ONLINE



PETZL PODIUM SUSPENSION SEAT

Designed for use in conjunction with a fall-arrest or work positioning Petzl Avao Bod Harness, wide seat provides great stability and leg mobility, rigid side edges prevent webbing straps from cutting into thighs, straps are adjustable with self-locking DoubleBack buckles, (3) equipment loops.

S70 - \$219.95



DBI SALA EXOFIT NEX BLACK-OUT ROPE ACCESS & RESCUE HARNESS

Aluminum front, back, and side D-rings; locking quick-connect buckles, hybrid comfort padding, ultra-soft edging, water-repellent webbing.

1113370 S - \$348.99

1113371 M - \$348.99

1113372 L - \$348.99

1113373 XL - \$348.99

Standard

1113345 S - \$364.99

1113346 M - \$364.99

1113347 L - \$364.99

1113348 XL - \$364.99



FRENCH CREEK NAVIGATOR ROPE ACCESS & RESCUE HARNESS

Dorsal D-ring; front sternum D-ring for connecting to fall arrest systems; front waist and side D-rings for positioning; includes equipment gear loops; padded waist belt and back/shoulder straps; 1-3/4" wide webbing.

22030B-BLK-XS XS - \$309.99

22030B-BLK-S/M S/M - \$309.99

22030B-BLK-L/XL L/XL - \$309.99

CUSTOMER CHOICE



PETZL AVAO BOD HARNESS

X-Shaped dorsal construction reduces pressure points during prolonged suspension, integrated fall indicator on the dorsal attachment point and is fastened with a triact-lock automatic locking carabiner, aluminum D-Rings, semi-rigid, wide waist belt and leg loops for positioning; waist belt and shoulder straps with self-locking DoubleBack buckles, fold-away side attachment points, (6) equipment loops on the sides and rear, (4) caritool tool holder retainers, (2) slots for tool bag tool pouch, can be paired with Petzl Podium Seat.

C71AAA1U Size 1 - \$404.95

C71AAA2U Size 2 - \$404.95

FAST buckles

C71AFA1U Size 1 - \$429.95

C71AFA2U Size 2 - \$429.95

FAST buckles, black-out version

C71AFN1U Size 1 - \$449.95

C710FN2U Size 2 - \$449.95

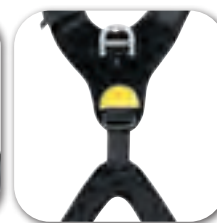

PETZL AVAO BOD CROLL FAST HARNESS

X-Shaped dorsal construction reduces pressure points during prolonged suspension, integrated croll ventral rope clamp for ascending ropes, aluminum D-Rings, semi-rigid, wide waist belt and leg loops for positioning; waist belt and shoulder straps with self-locking DoubleBack buckles, fold-away side attachment points, (6) equipment loops on the sides and rear, (4) caritool tool holder retainers, (2) slots for tool bag tool pouch.

C71CFA1U Size 1 - \$484.95

C71CFA2U Size 2 - \$484.95

CROLL, black-out version

C71CFN1U Size 1 - \$499.95

C71CFN2U Size 2 - \$499.95





WE'VE GOT
YOUR BACK



YOUR SAFETY COMPANY FOR LIFE

www.guardianfall.com

SIZING CHART ONLINE



PROTECTA PRO VEST-STYLE HARNESSES

Back D-ring, mating buckle chest strap, tongue buckle leg straps, spring-loaded torso buckles, lightweight hardware, built-in impact indicator.

- 1191236 S - \$56.99
- 1191237 M/L - \$56.99
- 1191238 XL - \$56.99



PROTECTA PRO VEST STYLE HARNESSES

Shoulder, back and leg moisture wicking comfort padding, back D-ring, tongue buckle leg straps, parachute torso adjusters, durable polyester web construction, built-in lanyard keepers, impact indicator, and protected labels.

- 1191429 S - \$75.99
- 1191430 M/L - \$75.99
- 1191431 XL - \$ 75.99

NEW



WESTFALL STEELHORSE HARNESSES

Single back D-ring, quick-connect chest strap, tongue buckle leg straps, pad/belt assembly can be removed for versatility, durable and lightweight.

- 840000 - \$99.99

NEW



GUARDIAN HALO HARNESSES

Based on award winning Edge series includes back steel D-ring, (5) points of adjustment, integrated lanyard keepers, black powder-coated hardware, and trauma straps.

Quick-connect chest, tongue buckle legs

- 481460 S - \$336.99
- 481461 M-XL - \$347.99
- 481462 2XL - \$354.99

Quick-connect chest & legs

- 481360 S - \$350.99
- 481361 M-XL - \$350.99
- 481362 2XL - \$384.99



DELTA VEST STYLE HARNESSES

Back D-ring, tongue buckle leg straps, water repellent webbing, lanyard parks, vertical torso adjuster.

- 1102000 - \$129.99
- 1102008 with side D-rings - \$141.99



ELK RIVER CONSTRUCTION PLUS HARNESSES

Sliding D-ring at center of back, parachute-mating buckles on leg straps, polyester construction, and fits M-XL.

- 48103 - \$34.99



FALLTECH CONTRACTOR HARNESSES

Single back D-ring, (5) point adjustability, EasyFit mating buckle leg straps, lanyard keeper, and heavy-duty polyester webbing.

- 7015XS XS - \$44.99
- 7015 UniFit - \$44.99
- 7015XL XL - \$44.99
- 70152X 2XL - \$44.99
- 70153X 3XL - \$44.99



GUARDIAN VELOCITY HARNESSES

Velocity HUV with chest pass-thru buckle and leg tongue buckles, break away lanyard keepers, identification label, finished webbing ends, webbing "wear" indicator.

01703 S-L - \$38.99

01704 XL/2XL - \$38.99

Pass thru leg buckles

01700 - \$38.99

GUARDIAN SERAPH CONSTRUCTION HARNESSES

(6) points of adjustment, quick-adjust torso buckles, improved elasticity in the shoulder and back for added comfort, hammer loops, web keepers, tongue buckle leg straps

11170 M/L - \$83.99

11172 XL/2XL - \$83.99

GUARDIAN SERAPH HARNESSES

(5) points of adjustment; pass-through chest buckle; tongue buckle leg straps, quick adjust torso buckles; break-away lanyard keepers; superior flexibility and comfort.

11164 M/L - \$63.99

11166 XL/2XL - \$63.99

Pass thru leg buckles

11160 M/L - \$54.99

11162 XL/2XL - \$54.99

GUARDIAN CYCLONE HUV HARNESSES

Back D-ring, unique X-Back design, aesthetic stitch pattern, fully adjustable shoulder, chest, and leg straps; chest quick-connect buckle, leg tongue buckles, identification patch allows users to customize their harnesses without jeopardizing webbing integrity.

21041 S - \$120.99

21042 M-L - \$120.99

21043 XL - \$120.99

21044 2XL - \$120.99

DBI SALA EXOFIT VEST-STYLE HARNESSES

Back D-ring, locking quick-connect buckles, cushioned shoulder, leg, and hip straps; Dri-lex breathable lining, soft LYCRA edging, strap keepers, 5-point adjustment, abrasion resistant, anti-tear ballistic nylon webbing.

1107975 S - \$296.99

1107976 M - \$296.99

1107977 L - \$296.99

1107981 XL - \$296.99



DELTA COMFORT VEST-STYLE HARNESSES

Built-in shoulder, back and leg comfort padding; fixed back D-ring, Tech-Lite quick-connect chest and leg straps; durable, lightweight polyester webbing; and built-in lanyard keepers.

1100935 S - \$196.99

1100936 M - \$196.99

1100937 L - \$196.99

1100938 XL - \$196.99



DBI SALA EXOFIT NEX VEST-STYLE HARNESSES

Aluminum back D-ring, locking quick-connect buckles, water-repellent webbing, vertical torso adjusters, protective shoulder caps, molded lanyard keepers, built-in carrying pocket, and integrated trauma straps.

1113001 S - \$352.99

1113004 M - \$352.99

1113007 L - \$352.99

1113010 XL - \$352.99





**GUARDIAN
SERAPH
CONSTRUCTION
HARNESSES**

6-point adjustability, quick-connect torso buckles, stretchability, hammer loops, web keepers, tongue buckle leg straps, dorsal and side D-rings, improved elasticity in the shoulder and back for added comfort, integrated impact indicator that clearly identifies if it has been exposed to forces of a fall, lanyard keepers.

- 11174 S - \$79.99
- 11173 M/L - \$79.99
- 11171 XL/2XL - \$79.99



**GUARDIAN
CYCLONE
HARNESSES**

(5) points of adjustment; quick-connect chest buckle; tongue buckle leg straps and waist, side D-rings; ultra-flow padding; break-away lanyard keepers; superior flexibility and comfort.

- 21029 S - \$154.99
- 21030 M/L - \$154.99
- 21031 XL - \$154.99
- 21032 2XL - \$165.99



**GUARDIAN
SERAPH
HARNESSES**

(5) points of adjustment; pass-through chest buckle; tongue buckle leg straps, quick adjust torso buckles; side D-rings; break-away lanyard keepers; superior flexibility and comfort.

- 11165 M/L - \$61.99
- 11167 XL/2XL - \$61.99



**MILLER AIRCORE
HARNESSES**

Open-core contoured padding, DuraFlex webbing, quick-connect chest and leg straps, cam buckles, removable belt with padding, steel hardware.

- AC-QC-BDP/UGN
- S/M - \$339.99
- L/XL - \$339.99
- 2XL/3XL - \$339.99
- With tongue buckle legs
- AC-TB-BDP/UGN*
- S/M - \$287.99
- L/XL - \$287.99
- 2XL/3XL - \$287.99
- With aluminum hardware
- ACA-QC-BDP/UGN*
- S/M - \$345.99
- L/XL - \$345.99
- 2XL/3XL - \$345.99



**FALLTECH
JOURNEYMAN
FLEX STEEL
HARNESSES**

3 D-rings on back and sides; tongue buckle leg straps; mating chest buckle; padding on shoulders, waist and legs for comfort; removable work belt; integrated dorsal strap keeps; steel hardware.

- 7035S S - \$152.99
- 7035M M - \$152.99
- 7035L L - \$152.99
- 7035XL XL - \$152.99
- 7035XXL 2XL - \$152.99
- 7035XXXL 3XL - \$152.99
- 7035XXXXL 4XL - \$152.99



**GUARDIAN
VELOCITY
HARNESSES**

3 D-rings on back and sides, pass-thru chest buckles, tongue buckle leg straps, dual break away lanyard keepers, finished webbing ends, and webbing "wear" indicator, lightweight and durable.

- 01705 S-L - \$53.99
- 01706 XL-2XL - \$55.99



DBI SALA EXOFIT CONSTRUCTION HARNESS

3 D-rings located on back and sides, built-in shoulder, back and leg comfort padding, body belt/hip pad, quick-connect chest strap, tongue buckle leg straps, anti-tear ballistic nylon, built-in reflective piping, parachute torso adjusters, protected labels equipped with i-Safe.

- 1110475 S - \$328.99
- 1110476 M - \$328.99
- 1110477 L - \$328.99
- 1110478 XL - \$328.99



DBI SALA EXOFIT NEX CONSTRUCTION HARNESS

Aluminum back and side D-rings, locking quick-connect buckles, sewn-in hip pad, removable belt.

- 1113121 S - \$354.99
- 1113124 M - \$354.99
- 1113127 L - \$354.99
- 1113130 XL - \$354.99
- With chest D-ring
- 1113151 S - \$374.99
- 1113154 M - \$374.99
- 1113157 L - \$374.99
- 1113160 XL - \$374.99



DBI SALA EXOFIT NEX VEST-STYLE HARNESS

Aluminum back and side D-rings, locking quick-connect buckles, water-repellent webbing, vertical torso adjusters, protective shoulder caps, molded lanyard keepers, built-in carrying pocket, X-design back for no-tangle donning, ultra-soft edging, integrated trauma straps.

- 1113046 S - \$382.99
- 1113049 M - \$382.99
- 1113052 L - \$382.99
- 1113055 XL - \$382.99
- With chest D-ring
- 1113076 S - \$382.99
- 1113079 M - \$382.99
- 1113082 L - \$382.99
- 1113085 XL - \$382.99



PROTECTA PRO CONSTRUCTION HARNESS

Back and side D-rings, hip pad and belt, tongue buckle leg straps, 420 lb capacity, built-in impact indicator, lightweight hardware, label cover, durable construction.

- 1191208 S - \$85.99
- 1191209 M/L - \$85.99
- 1191210 XL - \$85.99



PROTECTA CONSTRUCTION HARNESS

Back D-rings, body belt/hip pad with side D-rings, tongue buckle leg straps, moisture wicking comfort padding, tool and equipment rings, parachute torso adjusters, durable polyester web construction, built-in lanyard keepers, and impact indicator protected labels.

- 1191432 S - \$107.99
- 1191433 M/L - \$107.99
- 1191434 XL - \$107.99



PROTECTA PRO VEST-STYLE HARNESS

Back and side D-rings, shoulder, back and leg padding; quick-connect legs, spring-loaded torso buckles, lightweight hardware, built-in impact indicator, lanyard keeper.

- 1191259 S - \$149.99
- 1191260 M/L - \$149.99
- 1191261 XL - \$149.99





DBI SALA EXOFIT NEX OIL & GAS HARNESS

Vest-style, 18" dorsal D-ring extension, derrick attachments, hip pad and belt with lumbar D-ring, rigid seat sling with lifting D-rings, integrated trauma straps, water repellent webbing, reflective material on front and back. Pictured with 1003221 derrick belt (sold separately).

- 1113295 S - \$652.99
 - 1113296 M - \$652.99
 - 1113297 L - \$652.99
 - 1113298 XL - \$652.99
- Derrick belt**
- 1003230 S - \$286.99
 - 1003220 M - \$286.99
 - 1003221 L - \$286.99
 - 1003222 XL - \$286.99



DBI SALA EXOFIT DERRICK HARNESS

Vest-style, 18" dorsal D-ring extension, belt with back pad and lumbar D-ring, soft seat sling with positioning D-rings, pass-thru buckle connections at shoulders. Pictured with 1000570 derrick belt (sold separately).

- 1100300 S - \$425.99
 - 1100301 M - \$425.99
 - 1100302 L - \$425.99
 - 1100303 XL - \$425.99
- Derrick belt**
- 1000572 S - \$200.99
 - 1000573 M - \$200.99
 - 1000570 L/XL - \$200.99

DBI SALA DELTA II DERRICK HARNESS

Vest-style harness, 18" dorsal D-ring extension, belt with hip pad and lumbar D-ring, soft seat sling with positioning D-rings. Pictured with 1000570 derrick belt (sold separately).

- 1106112 S - \$363.99
- 1106108 M - \$363.99
- 1106106 L - \$363.99
- 1106107 XL - \$363.99

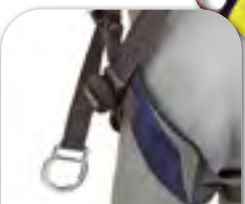

FALLTECH ROUGHNECK DERRICK BELT

Mating buckle connecting straps for upper torso attachment, (2) steel work positioning rings, tongue buckle belt.

- 8031S S - \$170.99
- 8031M M - \$170.99
- 8031L L - \$170.99
- 8031XL XL - \$170.99



FALLTECH ROUGHNECK DERRICK BELT

Mating buckle connectors for lower torso attachment, (2) steel work positioning rings, tongue buckle belt.

- 8035S S - \$211.99
- 8035M M - \$211.99
- 8035L L - \$211.99
- 8035XL XL - \$211.99



FALLTECH ROUGHNECK DERRICK HARNESS

(4) D-rings located on restraint, seat, and extension; tongue buckle legs and mating buckle chest, waist pad and belt, integral soft sling seat, upper torso mating buckles for 8031 derrick belt (sold separately).

- 8021S S - \$282.99
- 8021M M - \$282.99
- 8021L L - \$282.99
- 8021XL XL - \$282.99



FALLTECH ROUGHNECK DERRICK HARNESS

(4) D-rings located on back, hip-lifting, and extension; tongue buckle legs and mating buckle chest, lower torso mating buckles for 8035 derrick belt (sold separately).

- 8007S S - \$184.99
- 8007M M - \$184.99
- 8007L L - \$184.99
- 8007XL XL - \$184.99



VOLT®

Sleek design, spacious interior,
freedom to move with total ease.

ANSI rated

ANSI and CSA rated fall arrest and work positioning harness

The VOLT harness's adjusted fit and semi-rigid waistbelt combine work-positioning with a lightweight design. Quick and easy to put on, this form-fitting harness offers incredible freedom of movement. The VOLT allows sternum connection to ladder fall protection systems and ensures optimal comfort when fitted with a VOLT SEAT for hands-free work positioning.

www.petzl.com

Photo © www.kalice.fr



Access
the
inaccessible

SIZING CHART ONLINE

CUSTOMER CHOICE



PETZL VOLT WIND LT HARNES

EasyFit design to keep shape, fast buckles on waist belt and legs, dorsal and side d-rings, ladder climb attachment point for ventral attachment, extra wide waist belt, and wear protectors on waist belt and below dorsal point to limit wear.

- C72WFA-0U Size 0 - \$359.95
- C72WFA-1U Size 1 - \$359.95
- C72WFA-2U Size 2 - \$359.95



DBI SALA EXOFIT WIND ENERGY HARNES

Vest-style harness with quick-connect buckle chest and leg straps, PVC coated front, back, and side D-rings; integrated trauma straps, built-in lanyard keepers, parachute torso adjusters.

- 1102340 S - \$338.99
- 1102341 M - \$338.99
- 1102342 L - \$338.99
- 1102343 XL - \$338.99
- With gear loops & rings, body belt/hip pad
- 1102385 S - \$413.99
- 1102386 M - \$413.99
- 1102387 L - \$413.99
- 1102388 XL - \$413.99



DBI SALA EXOFIT NEX GLOBAL WIND ENERGY HARNES

Vest-style harness with aluminum front, back, and side D-rings; locking quick-connect buckles, sewn-in hip pad with belt, replaceable lumbar protector, radio holster conveniently holds and protects a radio, cell phone, or other item like a Lad-Saf sleeve.

- 1113215 S - \$486.99
- 1113216 M - \$486.99
- 1113217 L - \$486.99
- 1113218 XL - \$486.99
- With tongue buckle legs
- 1113175 S - \$483.99
- 1113176 M - \$483.99
- 1113177 L - \$483.99
- 1113178 XL - \$483.99

*Lad-Saf sleeve not included



ELK RIVER WINDEAGLE HARNES

(4) steel D-rings located on back, hips, and chest; quick-connect chest and leg straps, large comfort D-ring slider at back, lanyard parks, leg pads, made of nylon and polyester.

- 62432 S/L - \$115.99
- 62434 L/XL - \$115.99



CUSTOMER CHOICE

FALLTECH COMFORTECH CLIMBING HARNES

(4) D-rings located on back, sides, and front; quick-connect legs and chest, lumbar-supporting waist pad and belt.

- 7083SFD S - \$291.99
- 7083MFD M - \$291.99
- 7083LFD L - \$291.99
- 7083XLFD XL - \$291.99



NEW

SKYLOTEC IGNITE PROTON WIND HARNES

(4) attachment points, ergonomic high-tech hip airpad padding, anatomically preformed shoulder and leg padding clings to body and distributes the load optimally, back pad wear plate, color coding to identify the main anchoring points, tool and gear loops for every purpose.

- G-US-1137-WS
- XS-M - \$423.08
- M-2XL - \$423.08
- 2XL-5XL \$470.09

**KITS
SAVE
CASH**

All kits can be further customized, just give one of our Gear Experts a call.

**GME SUPPLY
WIND KIT**

This kit is designed for those working on wind energy turbines. Kit includes Petzl Volt Wind LT Harness, FallTech ViewPack Lanyard, Petzl Vertex Best Helmet, (2) 4-7/8" x 3" Steel Carabiners, GME Supply Large Black Deluxe Gear Equipment Bag. Helmet color options: white, red, yellow, blue, black, orange, and hi-viz yellow.

Upgrades available: Petzl Volt Wind LT Full Body Harness (No charge), DBI Sala ExoFit NEX Global Wind Energy Harness (+\$35.00), DBI Sala Force2 Elastic Lanyard (+\$150.00), GME Supply Wire Rope Grab with Carabiner (+\$149.00), DBI Sala 3/8" Wire Rope Grab with Carabiner (+\$395.00), Petzl Grillon Adjustable Positioning Lanyard (+\$180.00), Petzl Vizir Shadow (+\$60.00), JSP MK8 Evolution Hard Hat (+\$49.99), JSP MK8 Evolution Hard Hat with chin strap (+\$59.99).

90020 - \$649.99



**GME SUPPLY
SOLAR KIT**

This Solar Kit was developed for workers installing solar panels on roof tops. Kit includes Guardian Seraph Construction Harness with side D-rings, 6' FallTech Web Pass-Thru Anchor, Protecta Rebel 20' Web SRL, (2) 4-1/2" x 2-3/4" Steel Carabiners, Guardian HitchClip 3 Pack, Ergodyne Arsenal General Duty Gear Equipment Bag, GME Supply Canvas Bucket with leather bottom.

Upgrades available: Protecta Rebel 33' Cable SRL (+\$65.00), DBI Sala ExoFit XP Construction Positioning Harness (+\$253.00), 25 pack of Guardian HitchClips (+\$340.00), JSP MK8 Evolution Hard Hat (+\$49.99), JSP MK8 Evolution Hard Hat with chin strap (+\$59.99).

90030 - \$574.99



**GME SUPPLY
COMMERCIAL SOLAR KIT**

A versatile kit for workers that find themselves in many different environments. Kit includes Elk River Peregrine RAS Platinum Tower Climbing Harness, Petzl Vertex Best Helmet, FallTech 6' Web Pass-Thru Anchor, Kong Back-Up Mobile Fall Arrester, Sterling 7/16" HTP Static Rope 165', (2) 4-1/2" x 2-3/4" Steel Carabiners, GME Supply Large Black Deluxe Gear Equipment Bag, GME Supply Top-Closing Canvas Bolt Bag. Helmet color options: white, red, yellow, blue, black, orange, and hi-viz yellow.

Upgrades available: GME Supply Wire Rope Grab with Carabiner (+\$149.00), DBI Sala 3/8" Wire Rope Grab with Carabiner (+\$395.00), Petzl ASAP Lock Mobile Fall Arrester (+\$264.95), WestFall Pro Descender for 7/16" Rope (+\$200.00), Petzl I'D Small Self-Braking Rope Descender (+\$254.00), JSP MK8 Evolution Hard Hat (+\$49.99), JSP MK8 Evolution Hard Hat with chin strap (+\$59.99).

90040 - \$798.99



SIZING
CHART
ONLINE



DBI SALA SUSPENDED WORKMAN'S CHAIR

15" x 18" x 0.75" (38.1 cm x 45.7 cm x 1.9 cm) rigid board; built-in suspension rings with Saflok carabiner; durable polyester construction; adjustable suspension straps; integral side tool bags; compact and lightweight design; pass-thru style waist belt; aluminum foot step.

1001378 - \$305.99



FALLTECH PREMIUM BOSUN'S SEAT

Built with 13-ply Baltic Birch wood measuring 1" x 11.6" x 23.7" and equipped with sturdy side snaps to hang equipment or tools, durable 1-3/4" wide polyester webbing suspension straps, integrated tongue buckle body belt, seat and back pad for user support and comfort.

8039S S - \$284.99

8039M M - \$284.99

8039L L - \$284.99

8039XL XL - \$284.99

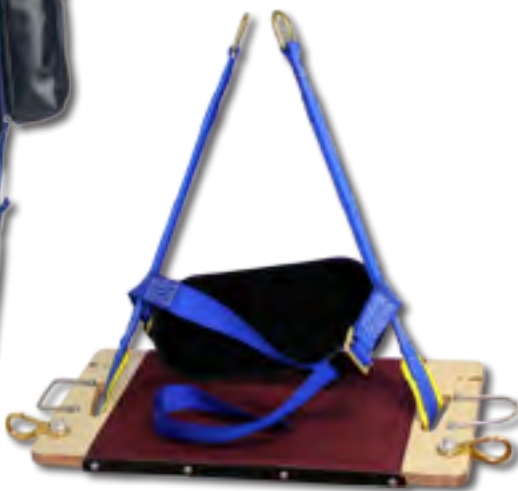

MIO BOSUN CHAIR

2-point suspension that allows the chair to tilt for extended outreach; bottom of the chair and the front edge are equipped with plastic protectors to reduce wear to the webbing; features tool holders and bucket clips.

SBWX-EX Without padded seat - \$165.99

SBWX-EXP With padded seat - \$232.99



DBI SALA EXOFIT NEX BELT

Tongue buckle belt made from durable polyester, ideal for added tool carrying options and back support. Available in sizes XS-4XL.

1000781 - \$77.99

1000716 ExoFit Belt - \$61.99



DBI SALA ADJUSTABLE RADIO / CELL HOLSTER

Adjusts to the size of virtually any portable radio or cell phone. D-Ring connection point. Can be used from a belt or harness. Ergonomic quick-cinch ergonomic cord lock.

1500088 - \$23.00



ELK RIVER RADIO HOLSTER

3 inches wide with elastic sides to hold large phones or radios, pass through loop for easy belt attachment, rugged hook/loop closure for attachment to shoulder or other vertical straps.

85008 - \$14.99



T-REIGN PROHOLSTER POUCH

Open-top protective case with a retractable tether, designed for two-way radios, fieldSENSE 2.0, GPS devices or small cameras that need some protection, but are ruggedly built and need to be within easy reach; rugged, 36" Kevlar tether is strong and durable, preventing drops or loss of gear; patented hook and latch closure system allows quiet, one-handed access to gear; constructed with rugged 600 denier nylon, tether cord can stretch to accommodate up to a 6" tall device, 2" wide x 1.1" deep.

908471 - \$29.99

SUSPENSION TRAUMA 101

Prompt rescue is critical in the event of fall. In just minutes, suspension trauma can set in and cause serious, potentially fatal damage. It's caused when the leg straps of a harness put pressure on the femoral artery, which causes blood to pool in the legs. This can deprive the brain, kidneys, and other vital organs of oxygen. As the blood sits uncirculated, it becomes toxic and highly acidic. Once pressure is released, that large amount of stagnant blood can rush back to the heart quickly and cause cardiac arrest. Suspension trauma straps are a simple accessory to help relieve pressure off of the harness leg straps.

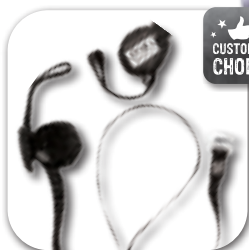

CUSTOMER CHOICE **VIDEO**

DBI SALA SUSPENSION TRAUMA SAFETY STRAPS

Deploy when needed and hook together in seconds, allows suspended worker to stand up in harness and relieve downward pressure, continuous loop design allows for one-foot or two-foot suspension. Connects to most harnesses, one pair.

9501403 - \$29.99



KITS SAVE CASH

GME SUPPLY CARABINER VARIETY PACK

Buy in bulk and save, pack of 10 includes our most popular carabiners: (4) 4-7/8" x 3" 7400 carabiners; (2) 4-1/2" x 2-3/4" 7405 carabiners; (2) 7" x 3-3/4" 7420 carabiners; (2) 7" x 4-1/2" 7430 carabiners.

CARABINERPACK - \$199.99



DBI SALA D-RING EXTENSION FOR HARNESS

18" D-ring Extension for a harness has a snaphook at one end and a D-ring at the other end, making hooking up a lot easier than trying to attach something to your own back.

1231117 - \$55.99



GUARDIAN EXTENSION LANYARD WEB LOOP END

Lanyard offers the convenient option of lengthening a full-body harness D-ring.

01122 - \$19.99

01121 Snap hook end - \$32.99



ROCK EXOTICA TRANSPORTER TOOL CARRIER

Tool holder for harness with manual locking gate. Wing design for one hand usage. Shelf area to stack and sort gear. Includes screws to install on harness. WLL: 50 lbs, MBS: 400 lbs.

C5M - \$60.00



SQUIDS GLOVE GRABBER, DUAL CLIP

Clips to clothing, belts, tool belts, and D-rings; durable and detachable; breakaway feature; dielectric / non-conductive material. Available in hi-vis orange, hi-vis lime, blue, and black.

3400 - \$2.50

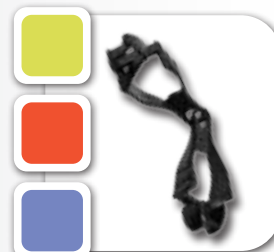

MILLER RELIEF STEP SAFETY DEVICE

Provide a short-term solution for alleviating suspension trauma; enhances blood circulation until rescue, includes (1) step.

9099 - \$17.29



GUARDIAN TRAUMA STRAPS

Lightweight and easy to install; compatible with all Guardian harnesses; easy to adjust and its low profile keeps out of the way during work.

10733 - \$23.99



PETZL CARITOOOL

Detachable equipment carrier for hanging pulley on harness, stainless steel gate, glass fiber reinforced plastic frame.

P42 - \$8.99





3M Science.
Applied to Life.™

Safety products that work as hard as you do.

A leader in safety. A leader in fall protection. We've joined forces to create a safer future. The products, people and service of the trusted DBI-SALA® fall protection brand are now part of 3M. That means 3M now carries comprehensive portfolio of quality products for the electrical utilities industry. Together we can help you elevate your employees' safety and comfort to new heights.

3M Science. Applied to Life.™



3M™ E-A-Rsoft™ Yellow Neon™ Blasts™ Corded Earplugs

Seal the ear canal with soft, slow-recovery foam for excellent noise reduction and comfort.

- Poly bag keeps each pair of earplugs clean before use
- Regular size fits most ear canals
- Noise Reduction Rating 33 dB



3M™ 6000 Series Full Facepiece Reusable Respirator

This full facepiece reusable respirator offers lightweight comfort and ease of use.

- Large lens for wide field of view and excellent visibility
- Cool Flow™ Valve for cooler, drier comfort
- Wide selection of filters/cartridges available



3M™ DBI-SALA® ExoFit™ NEX™ Tower Climbing Harness

When you have lightweight and comfort, you also have productivity and efficiency. Climb higher with the ultimate in comfort, durability and function.

- Duo-Lok™ quick connect chest and leg straps
- Hybrid shoulder, back and leg comfort padding
- Tech-Lite™ aluminum front and side D-rings

6 FT vs 12 FT FREE FALL

6 FT FREE FALL

A 6'
B 4'
C 6'
D 2'
=18'

12 FT FREE FALL

A 12'
B 5'
C 6'
D 2'
=25'

6 FT FREE FALL **12 FT FREE FALL** LOOK FOR THESE BADGES THROUGHOUT THE CATALOG.

CALCULATING FREE FALL

$A + B + C + D =$
TOTAL FALL CLEARANCE

A. Freefall distance
Original working length before a fall event occurs/before activation of energy absorber.

B. Shock pack deployment
Maximum allowable amount of elongation that may payout from the energy absorber upon activation during a fall event.

C. Height of dorsal D-ring
Typical average height of the dorsal D-Ring on a user's full body harness measured from the walking/working surface up.

D. Harness stretch & dorsal D-ring shift + safety factor
Combined amount of harness webbing elongation and dorsal back D-ring up-shift during entire fall event.

Typical twin leg lanyards are designed to arrest the forces associated with a maximum fall distance of 6 feet. Ideally, your anchorage is above you, so a standard 6 foot lanyard that's attached to your dorsal D-ring will limit your free fall to an acceptable distance.

When you don't have an overhead anchorage, your fall distance increases. The lanyard won't begin to stop you until your lower anchorage is now above you. A standard lanyard is not designed to safely stop you while you're falling from that distance. There are specially designed lanyards for these situations.

12 foot free fall lanyards have a maximum deployment distance of 60", so fall clearance needs to be taken into account. Fall clearance is the distance below your anchorage point that you'll fall without hitting the surface, or a structure below you. To calculate for a standard 6 foot free fall from an overhead anchor, take the length of the lanyard, 6 feet, plus the shock pack deployment, 48 inches, or 4 feet. Then, add your overall height, let's say 6 feet. So far we're at 16 feet of clearance. Finally, add a safety factor, 2 feet, to account for things like harness stretch and shifting. For this scenario, you'd need at least 18 feet of fall clearance before the nearest obstruction

to safely work. A foot level anchor requires more distance for the lanyard to begin stopping the fall, even though both lanyards are still 6 feet in length.

There are also some lanyards available which can be used in both 6 foot and 12 foot free fall scenarios. Check the badges and descriptions to find the right lanyard for you. If you have more questions, give one of our Gear Experts® a call.





GUARDIAN BIG BOSS EXTENDED FREE FALL SHOCK ABSORBING LANYARD

The Big Boss can be used as an extended free fall lanyard for free falls up to 12 feet for a weight capacity range of 130-310 lbs. Use as a standard shock absorbing lanyard for a weight capacity range of 310-420 lbs. Snaphook center / rebar hook ends, 6' length, ANSI compliant.

21303 - \$138.99



WESTFALL PRO BLACK-MAX SHOCK ABSORBING LANYARD

Created with tower work in mind, the bungee style allows the lanyard to stretch and prevent trip hazards throughout the day, while the dual stage shock absorbers have been designed to arrest forces associated with a free fall of up to 12'. Aluminum snaphook center / aluminum rebar hook ends, 6' length, ANSI compliant.

62022 Aluminum rebar hook ends - \$209.99

62021 Steel rebar hook ends - \$174.99



DBI SALA FORCE2 ELASTIC LANYARD

Force2 12' free fall (3.6 m) and dual capacity rated; stretches in reaction to your movements; energy absorbing design limits fall arrest forces; ideal when there is no overhead anchorage and your only option is to tie-off at your feet, snaphook center / aluminum rebar hook ends, 6' length, ANSI compliant.

1246032 - \$337.99



SKYLOTEC SKYSAFE PRO FLEX SHOCK ABSORBING LANYARD

Aluminum snaphook center / aluminum rebar hook ends, 6' length, designed for foot level tie-off, ANSI compliant.

L-0558-1,8 - \$297.99

L-0562-1,8 Steel hardware - \$219.99

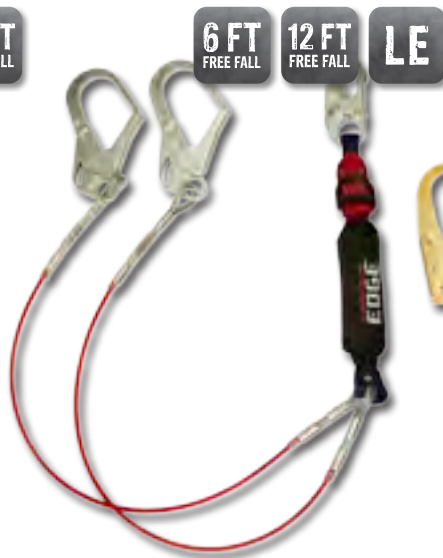

FALLTECH LEADING EDGE RESTRAINT LANYARD

Steel snaphook center / steel rebar hook ends, 6' length, 1/4" heavy duty abrasion and cut resistant steel cable, internal shock absorber limits arresting forces to 1,800 lbs or less, WrapBack cover protects absorber, for workers between the capacity of 130-310 lbs.

8354LEY3D - \$239.99



FALLTECH IRONMAN FREEFALL LANYARD

Aluminum snaphook center / aluminum rebar hook ends, 6' length, designed for foot level tie-off, internal shock absorber limits arresting forces to 1,800 lbs or less, tensile strength of 8,500 lbs.

8247Y3 - \$150.99



PETZL ABSORBICA-Y INTERNATIONAL

MGO connectors and steel carabiner with Triact-Lock auto-locking system, for workers between the capacity of 110-286 lbs, 6' length, ANSI compliant.

L64YUM-150 - \$299.95

Tie-back

L64YUT-150 - \$349.95

STEEL REBAR HOOKS



6 FT
FREE FALL

CUSTOMER
CHOICE

VIDEO



6 FT
FREE FALL

PROTECTA PRO SHOCK ABSORBING LANYARD

Stretches in reaction to your movements; abrasion resistant polyester tubular webbing; energy absorbing design limits fall arrest forces, built-in impact indicator; snaphook center / rebar hook ends, stretches 4.5'-6'.

1340161 - \$96.99



6 FT
FREE FALL

WESTFALL PRO SHOCK ABSORBING LANYARD

Made with abrasion-resistant nylon webbing; sewn on impact indicator; snaphook center / rebar hook ends, stretches 4.5'-6', ANSI compliant.

62010 - \$114.99

ELK RIVER SHOCK ABSORBING FLEX NOPAC LANYARD

Expandable design keeps lanyard legs out of your way, 100% tie-off, Z snaphook center / rebar hook ends, stretches 4.5'-6', ANSI compliant.

35478 - \$105.99

35428 Z snaphooks at all ends - \$90.99

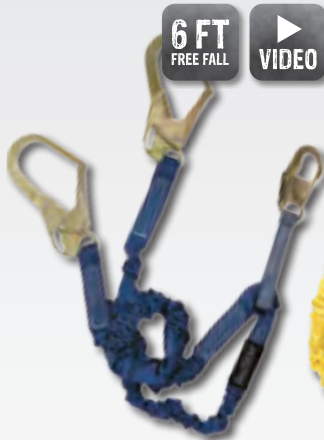

6 FT
FREE FALL

VIDEO



6 FT
FREE FALL

VIDEO



6 FT
FREE FALL



6 FT
FREE FALL



6 FT
FREE FALL

FALLTECH ELASTECH SHOCK ABSORBING LANYARD

Snaphook center / rebar hook ends, stretches 4.5'-6', ANSI compliant.

8240Y3 - \$115.99

8240Y Snaphook ends - \$72.99

DBI SALA SHOCKWAVE2 SHOCK ABSORBING LANYARD

3" gate SafLok Max hook ends, stretches 4.5'-6', ANSI compliant.

1244448 - \$317.99

GUARDIAN STRETCH SHOCK ABSORBING LANYARD

Snaphook center / rebar hook ends, stretches 4.5'-6', ANSI compliant.

01298 - \$92.99

ELK RIVER FLEX ZORBER SHOCK ABSORBING LANYARD

Snaphook center / rebar hook ends, split leg 3' or 6', ANSI compliant.

36966 - \$120.99

DBI SALA SHOCKWAVE2 SHOCK ABSORBING LANYARD

Snaphook center / Saflok Tower Hook ends, stretches 4.5'-6', ANSI compliant.

1244416 - \$392.99

ELK RIVER NOPAC SHOCK ABSORBING LANYARD

Shock absorbing material is covered with a full-strength outer sheath, 100% tie-off, Z snaphook center / Z rebar hook ends, 6' length, ANSI compliant.

35386 - \$73.99



6 FT
FREE FALL

CUSTOMER CHOICE

FALLTECH ELASTECH SHOCK ABSORBING LANYARD

Durable tubular polyester outer jacket web resists abrasion and UV, full-length internal energy absorber, contrasting load-indicator stitch displays when a fall event has occurred, snaphook center / rebar hook ends, 6' length, ANSI compliant.

8259Y3 - \$69.99



6 FT
FREE FALL



6 FT
FREE FALL

FALLTECH FT BASIC SHOCK ABSORBING LANYARD

Snaphook center / rebar hook ends, 6' length, ANSI compliant.

8256LTY3 - \$75.99



6 FT
FREE FALL

6 FT
FREE FALL

6 FT
FREE FALL

6 FT
FREE FALL

6 FT
FREE FALL

FALLTECH VIEWPACK VINYL-COATED CABLE LANYARD

Snaphook center / rebar hook ends, 6' length, ANSI compliant.

8357Y3 - \$124.99

GUARDIAN SHOCK ABSORBING LANYARD

Snaphook center / rebar hook ends, 6' length, ANSI compliant.

11203 - \$81.99

DBI SALA SHOCKWAVE2 SHOCK ABSORBING LANYARD

D-ring extension; snaphook center / steel hook ends, stretches 4.5'-6', ANSI compliant.

1244456 - \$247.99

DBI SALA EZ-STOP SHOCK ABSORBING LANYARD

Snaphook center / rebar hook ends, 6' length, ANSI compliant.

1246024 - \$221.99

ELK RIVER NOPAC SHOCK ABSORBING LANYARD

Snaphook center / steel auto-twist lock carabiners ends, 6' length, ANSI compliant.

35406 - \$112.99

ALUMINUM REBAR HOOKS



6 FT FREE FALL
CUSTOMER CHOICE

FALLTECH ELASTECH SHOCK ABSORBING LANYARD

Expands and contracts to avoid tripping hazards, internal high modulus elastic won't soften from frequent use, heavy-duty tubular polyester outer jacket web resists abrasion and UV, aluminum snaphook center / aluminum rebar hook ends, stretches 4.5'-6', ANSI compliant.

8240Y3A - \$157.99



6 FT FREE FALL

DBI SALA EZ-STOP SHOCK ABSORBING LANYARD

Lightest, strongest, smallest shock pack in the world; water-repellent webbing, protected labels, aluminum snaphook center / aluminum rebar hook ends, 6' length, ANSI compliant.

1246193 - \$292.99



6 FT FREE FALL

GUARDIAN SHOCK ABSORBING LANYARD

Made with a heavy-duty outer polyester webbing; polyester core specifically designed to reduce the impact forces resulting from a fall; shock absorption is built directly into the lanyard so there is no need for an external shock absorber, making the lanyard lightweight; aluminum snaphook center / high strength aluminum rebar hook ends, 6' length, ANSI compliant.

21215 - \$104.99



6 FT FREE FALL

6 FT FREE FALL

6 FT FREE FALL

VIDEO

6 FT FREE FALL

VIDEO

6 FT FREE FALL

VIDEO

DBI SALA EZ-STOP SHOCK ABSORBING LANYARD

Aluminum snaphook center / aluminum rebar hook ends, stretches 4.5'-6', ANSI compliant.

1246021 - \$272.99

DBI SALA SHOCKWAVE2 SHOCK ABSORBING LANYARD

Snaphook center / aluminum rebar hook ends, stretches 4.5'-6', ANSI compliant.

1244409 - \$272.99

ELK RIVER FLEX NOPAC SHOCK ABSORBING LANYARD

Z snaphook center / aluminum Z rebar hook ends, 6' length, ANSI compliant.

35488 - \$119.99

ELK RIVER FLEX NOPAC SHOCK ABSORBING LANYARD

Z snaphook center / aluminum carabiner ends, stretches 4.5'-6', ANSI compliant.

35416 - \$136.99

ELK RIVER FLEX NOPAC SHOCK ABSORBING LANYARD

Aluminum carabiner center and ends, stretches 4.5'-6', ANSI compliant.

35716 - \$171.99

**DBI SALA
EZ-STOP
TIE-BACK
SHOCK
ABSORBING
LANYARD**

Lightest, strongest, smallest shock pack in the world; water-repellent webbing, protected labels, floating D-rings for tie-back, aluminum snaphook center / aluminum rebar hook ends, 6' length, ANSI compliant.

1246071 - \$288.99



**FALLTECH
VIEWPACK
TIE-OFF
SHOCK
ABSORBING
LANYARD**

Rugged 1" polyester webbing provides extreme UV resistance, exclusive ViewPack design combines integral protection of labels and view-window for inspection of internal energy absorber, tear-away absorber design limits fall forces to 900 lbs or less, snaphook center / rebar hook ends, 6' length, ANSI compliant.

8260732D - \$103.99



**DBI SALA EZ-STOP TIE-BACK
SHOCK ABSORBING LANYARD**

Smallest shock absorber in the world, thinnest-ever webbing for reduced weight and bulk, lightest and strongest rebar hooks on the market, Hi-10 Vectran Energy Management Material, floating D-rings for tie-back, snaphook center / rebar hook ends, 6' length, ANSI compliant.

1246072 - \$248.99



**ELK RIVER TIE-BACK
SHOCK ABSORBING
LANYARD**

Z snaphook center / tie-back carabiner ends, 6' length, ANSI compliant.

36936 - \$112.99



**GUARDIAN TIE-BACK
SHOCK ABSORBING
LANYARD**

Snaphook center and ends, 6' length, ANSI compliant.

01291 - \$80.99



**PETZL ABSORBICA-Y
TIE-BACK SHOCK
ABSORBING LANYARD**

Steel carabiner with triact-lock auto-locking system, MGO large-opening connectors, 6' length, ANSI compliant.

L64YUT-150 - \$349.95



**DBI SALA EZ-STOP
WRAPBAX SHOCK
ABSORBING LANYARD**

Aluminum snaphook center / 5,000 lb Wrapbax 2 hook ends, 6' length, ANSI compliant.

1246080 - \$223.99



**GUARDIAN TRIPLE
LOCK WRAP
LANYARD**

Can function as a standard shock absorbing lanyard or tie-back lanyard; triple locking carabiner ends; 6' length, ANSI compliant.

11760 - \$101.99



GUARDIAN SHOCK ABSORBING LANYARD

Integrated shock absorbing component limits average arresting forces to 900 pounds or less; comprised of 1" nylon webbing; clear shock absorbing pack for easy inspection; snaphook ends; 3' length; ANSI compliant. Also available in a variety of lengths with steel and aluminum snaphooks or rebar hooks.

01214 - \$25.99



PROTECTA PRO PACK SHOCK ABSORBING LANYARD

Durable 1" polyester webbing, 3,600 lb gated hooks, energy absorbing design that limits the average fall arresting forces to 900 lbs, snaphook ends, ANSI compliant.

1341002 3' length - \$39.99

1341001 6' length - \$39.99

SEE ROPE GRABS ON PAGE 68



DBI SALA EZ-STOP SHOCK ABSORBING LANYARD

Snaphook ends, ANSI compliant.

1246012 3' length - \$92.99

1246011 6' length - \$98.99



FALLTECH SOFT PACK SHOCK ABSORBING LANYARD

Snaphook ends, ANSI compliant.

8256LT3FT 3' length - \$34.99

8256LT 6' length - \$36.99



ELK RIVER NOPAC SHOCK ABSORBING LANYARD

Z snaphook ends, stretches 4.5'-6', ANSI compliant.

35427 - \$52.99



FALLTECH VIEWPACK SHOCK ABSORBING LANYARD

Snaphook ends, ANSI compliant.

8253 3' length - \$35.99

8254 4' length - \$42.99

8256 6' length - \$42.99



ELK RIVER ZORBER SHOCK ABSORBING LANYARD

Snaphook ends, ANSI compliant.

27223 3' length - \$44.99

27224 4' length - \$44.99

27225 5' length - \$44.99

27226 6' length - \$44.99



DBI SALA EZ-STOP ADJUSTABLE SHOCK ABSORBING LANYARD

Lightest, strongest, smallest shock pack in the world; redesigned steel snaphooks for lighter weight, water repellent webbing, protected labels, snaphook ends, adjusts from 4.5'-6', ANSI compliant.

1246234 - \$105.99

GUARDIAN ADJUSTABLE SHOCK ABSORBING LANYARD

Ideal for fall arrest and restraint applications; lightweight; can be quickly and easily adjusted; comes with an integrated shock absorbing component; snaphook ends, adjusts from 4.5'-6', ANSI compliant.

01285 - \$62.99



FALLTECH ELASTECH SHOCK ABSORBING LANYARD

Aluminum snaphook end / aluminum rebar hook end, stretches 4.5'-6', ANSI compliant.

82403A - \$90.99

8240A Aluminum snaphook ends - \$79.99



MILLER MANYARD II SHOCK ABSORBING LANYARD

Elastic web and snaphook end / tie-back carabiner end; 6' length, ANSI compliant.

216M-Z7-6FTGN - \$87.99



GUARDIAN SHOCK ABSORBING TIE-BACK LANYARD

Adjustable D-ring tie-back point; snaphook ends; 6' length, ANSI compliant.

01290 - \$68.99



GUARDIAN TRIPLE LOCK WRAP LANYARD

Can function as a standard shock absorbing lanyard or tie-back lanyard; triple locking carabiner end; 6' length, ANSI compliant.

11750 - \$76.99



ELK RIVER NOPAC SHOCK ABSORBING LANYARD

Z snaphook end / Z rebar hook end, 6' length, ANSI compliant.

35376 - \$51.99



ELK RIVER POSITIONING WEB LANYARD

Z snaphook ends, 3,600 lb (3.6 m) gate, 1" wide webbing.

29023 3' length - \$28.99

29024 4' length - \$28.99

29026 6' length - \$28.99

29506 Adjustable 3'-6' length - \$33.99



GUARDIAN ADJUSTABLE POSITIONING WEB LANYARD

Ideal for positioning and restraint situations, quickly adjusts from 4' to 6', snaphook ends.

01280 - \$30.99



ELK RIVER CENTURION ROPE LANYARD

1/2" wide with two 3/4" centurion snaphooks at each end, 3,600 lb. (3.6 m) gate, and ANSI compliant.

28013 3' - \$37.99

28014 4' - \$37.99

28016 6' - \$37.99



ELK RIVER POSITIONING WEB LANYARD

Z snaphook end / Z rebar hook end.

29433 3' length - \$40.99

29434 4' length - \$40.99

29436 6' length - \$40.99



ELK RIVER ADJUSTABLE 1/2" ROPE POSITIONING LANYARD

1/2" x 6' rope adjustable positioning lanyard, polyester and nylon rope construction, captive eye carabiner with 3.6 m gate, aluminum sliding adjuster, 1/2" gate opening carabiner, man rated to 310 lbs for positioning only, separate fall arrest required, maximum load: 3600 lbs. Meets or exceeds OSHA 1926.

34496 - \$94.95



KONG TRIMMER ADJUSTABLE WORK POSITIONING LANYARD

Incredibly smooth device for progressive adjustment of the lanyard length; used on the work positioning D-rings on the harness waist belt; the length is adjusted by pressing the ergonomic lever; can be used from the ventral or lateral attachment points to adjust the distance from the anchoring point; fitted with protective sheath to protect the rope from the contact points; visible stitching for a quick visual inspection; lightweight and compact.

289U00200KK 2 m - \$173.99

289U00300KK 3 m - \$178.99



DBI SALA ADJUSTABLE ROPE POSITIONING LANYARD

Compliments a variety of fall protection systems as a versatile positioning device, allowing the user to wrap around numerous anchors; lightweight design weighs just 2.2 lbs, abrasion resistant sleeve helps prolong product life, blue wear indicating core signals the user when the product needs to be taken out of service, 8' length.

1234070 - \$194.99



PETZL GRILLON ADJUSTABLE POSITIONING LANYARD

Lanyard with fine adjustment system for precise work positioning; can be used in double mode to distribute weight on the belt or single mode to distribute weight between the waist belt and leg loops; removable protective sheath protects the rope from abrasive surfaces and allows smooth rope glide.

L52A 002 2 m (6.56') - \$184.95

L52A 003 3 m (9.84') - \$189.95

L52A 005 5 m (16.40') - \$199.95

With hook connector

L52H 002 2 m (6.56') - \$204.95

L52H 003 3 m (9.84') - \$209.95

L52H 004 4 m (13.12') - \$214.95

L52H 005 5 m (16.40') - \$219.95

With MGO rebar hook connector (does not include sheath).

MG00 60 Auto-locking connector (connector only, use in conjunction with L52A) - \$69.95

Replacement straps

L52R 002-020 Multiple lengths - Price varies

L5RH 002-005 Multiple lengths - Price varies



L52H



MG00 60

NEW

SKYLOTEC LORY POSITIONING LANYARD

Lightweight adjustable positioning lanyard with descender; 2 meter rope, 2 sewn eyes, and a protective sheath protects the rope from abrasive surfaces and allows smooth rope glide. Carabiner not included.

I-0691-2 - \$189.99

I-0693-1 With steel

snaphook - \$209.99

I-0695-1 With aluminum rebar hook - \$232.99



NEW



ELK RIVER QUICK-ADJUSTABLE ROPE POSITIONING LANYARD

5/8" x 6' polyester kernmantle rope, captive eye carabiner / ErgoGrip adjuster with carabiner.

34416 - \$134.99



ELK RIVER QUICK-ADJUSTABLE ROPE POSITIONING LANYARD

5/8" x 6' 3-strand nylon rope, 3/4" snaphook / rope grab with carabiner.

34406 - \$51.99



FALLTECH TOWER CLIMBER ADJUSTABLE ROPE POSITIONING LANYARD

Aluminum auto-locking rope adjuster built for one handed length adjustment; durable 7/16"(11 mm) kernmantle rope; abrasion resistant sleeve; includes gear bag for easy storage when climbing; 6.5' length.

8165A65 - \$134.99



PROTECTA ADJUSTABLE WEB POSITIONING LANYARD

Made from abrasion resistant polyester webbing, with built-in wear indicator, lightweight and adjustable, 6' length, snaphooks ends.

1385301 - \$35.99



ELK RIVER REBAR CHAIN ASSEMBLY
25-1/2" with 3/4" Centurion snaphook ends and adjuster form hook center, ANSI compliant.
13420 - \$51.99



ELK RIVER REBAR CHAIN ASSEMBLY WITH SWIVEL
25-1/2" with 3/4" Centurion snaphook ends and adjustable swivel hook center, ANSI compliant.
13425 - \$53.99



PROTECTA REBAR CHAIN ASSEMBLY
20" with snaphook ends and large flat steel hook center.
AF77710 - \$52.99



ELK RIVER REBAR WEB ASSEMBLY
3/4" Centurion snaphook ends and 2-1/2" Centurion rebar hook center, ANSI compliant.
29740 14" - \$61.99
29741 18" - \$61.99
29743 24" - \$61.99



ELK RIVER REBAR WEB ASSEMBLY WITH SWIVEL
18" with 3/4" Centurion snaphook ends and 2-1/2" Centurion rebar swivel hook center, ANSI compliant.
29761 - \$74.99



DBI SALA WEB REBAR ASSEMBLY WITH SWIVEL
22" with locking snaphook ends and swiveling 2-1/4" aluminum rebar hook center, ANSI compliant.
1231520 - \$172.99



WESTFALL PRO SEPARATOR SPREADER BAR SNAPHOOK
9-3/4" x 2-1/4", 3/4" throat opening, 22.2 kN, double locking snaphooks, ANSI compliant.
07475 - \$34.99

SEE HARDWARE }
ON PAGE 58



WESTFALL PRO TOWER POSITIONING KIT

Kit includes the following components: 2-1/4" swivel form hook, 3/4" spreader bar, 3/4" fall rated steel carabiner, ANSI compliant.

13400 - \$89.99

07475 Spreader bar only - \$34.99



ELK RIVER POSITIONING DEVICE

2-1/4" throat opening swivel hook, 3/4" throat opening centurion auto-locking separator snaphooks, 16" length.

29701 - \$55.99

FALLTECH WEB / REBAR POSITIONING ASSEMBLY

Aluminum rebar hook with 2.5" gate opening, aluminum snaphooks, two-layer jacketed web for wear resistance, 24" length.

8250LTA - \$108.99



Comfort & Convenience Just Got Better

SKYLOTEC offers you a NEW light weight, innovative and functional range of fall protection, work positioning and rescue equipment that meets the needs of high risk tower climbers.



IGNITE PROTON TOWER Harness



LORY PRO Work Positioning Device



DEUS 3300 Descent & Rescue Device



PEANUT Retractable type Fall Arrester

**INDUSTRY-BORN.
SPORTS-DRIVEN.**



SKYLOTEC develops and produces highly specialized fall protection systems for industry and sports.



SRL, SRD, PFL 101

WHAT IS A SELF-RETRACTING LIFELINE?

A Self-Retracting Lifeline, or SRL, is a device that contains a spring loaded retracting web or cable lanyard wound around an internal drum. It automatically locks and arrests the fall of a worker.

CLASS A vs CLASS B

ANSI Z359.14-2012 classifies Self-Retracting Lifelines and Personal Fall Limiters into two classes. The main differentiators between the two are stopping distance and arresting forces.

Class A

- Maximum arresting distance not to exceed 24".
- Average arresting force not to exceed 1,350 pounds or 6 kN or have a maximum peak of 1,800 pounds or 8 kN.
- After environmental conditioning (hot, cold, wet), average arresting force not to exceed 1,575 pounds or 7 kN or a maximum peak of 1,800 pounds or 8 kN.

Class B

- Maximum arresting distance not to exceed 54".
- Average arresting force not to exceed 900 pounds or 4 kN or have a maximum peak of 1,800 pounds or 8 kN.
- After environmental conditioning (hot, cold, wet), average arresting force not to exceed 1,125 pounds or 5 kN or a maximum peak of 1,800 pounds or 8 kN.

CLASS
A

CLASS
B

LOOK FOR THESE
BADGES THROUGHOUT
THE CATALOG.

SWING FALL

SRLs are great because they allow you to work much farther away from an anchorage point, sometimes over 100 ft. The downside to this is swing falls become much more of a danger.

A swing fall occurs when an anchorage point is not directly overhead of a worker. The device will stop them in the required distance, but the worker may still swing a great distance. This potentially puts other obstacles, walls, or objects in the path for the worker to collide with.

To avoid swing falls, always stay in the safe zone, which is within 30 degrees of your anchor point. Swing falls can be avoided by using mobile anchorage points which will travel with the worker.

BODY WORN vs MOUNTED

Larger SRLs are mounted above the worker, and the lanyard runs down to connect to the user's dorsal D-ring on their harness. These come in lengths ranging from 8 ft to over 100 ft. The other option is body worn. These are compact devices which connect directly to the users harness and are much shorter, generally 6 or 8 ft. To tie-off the user connects the tether to an anchorage point. These can also be had in twin-leg configuration for 100% tie-off.

LEADING EDGE + FOOT LEVEL

Most SRLs are designed only to be mounted above the user. For cases where this is not possible, specially designed Foot Level or Leading Edge SRLs are required. ANSI classifies these as SRL-LE devices. These incorporate factors to absorb the

extra energy associated with foot-level tie off, as well as more robust cables to resist breaking when run against a leading edge.

LE

LOOK FOR THIS BADGE
THROUGHOUT THE CATALOG.

REPLACEMENT & RECERTIFICATION

Recertification can be done on some SRLs by the manufacturer to prolong the life of the unit. This can be done after the device is involved in a fall, or after the unit has been in the field for a specific period of time. Check with the manufacturer for specifications on recertification.

Other devices cannot be recertified and must be destroyed and replaced if they are involved in a fall or after a time period specified by the manufacturer.

OTHER VARIATIONS

Other potential options for SRL variations include:

- Sealed design for harsh work environments with grease, dust, and moisture.
- Rescue Devices, referred to as SRL-R by ANSI, for auto retrieval. These are common on confined space systems.
- Tie-Back for when connectors cannot secure to anchorage points.
- Arc Flash rated for working in electrical environments.

More questions?

Give our Gear Experts® a call.

FREE
DOWNLOAD

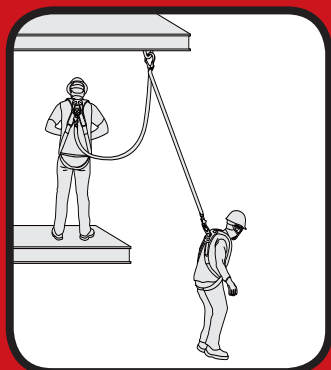

SWING FALL

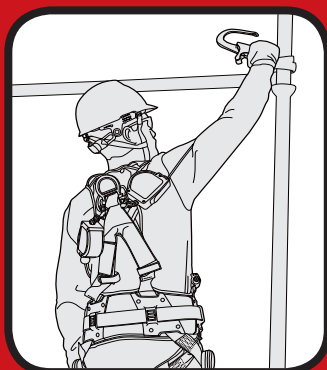

BODY WORN



MOUNTED



LEADING EDGE

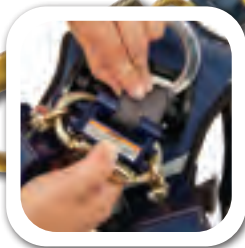

CLASS B

CUSTOMER CHOICE

DBI SALA NANO-LOK 6' TWIN LEG SRL

Attaches directly to back of most harnesses, installs to webbing, leaves dorsal D-ring open, limits lifeline twisting for smoother operation, high-strength housing provides maximum durability, replaces twin-leg lanyard and improves safety, stops falling worker within inches, ANSI compliant, quick-connector anchorage connection with aluminum rebar hook ends.

3101277 6' - \$410.99

3101280 Steel rebar hook ends - \$427.99

3101279 Steel snaphook ends - \$436.99

3101225

3101227

3101235

3101215

3101226

3101253



DBI SALA NANO-LOK SINGLE LEG SRL

Attaches directly to back of most harnesses, leaves dorsal D-ring open, stops falling worker within inches, ANSI compliant.

PART	END CONNECTOR	UNIT CONNECTOR	PRICE
3101225	Aluminum Captive Eye Carabiner	Single Leg	\$179.99
3101227	Aluminum Rebar Hook	Single Leg	\$215.99
3101235	Aluminum Captive Eye Carabiner	Aluminum Carabiner	\$166.99
3101215	Steel Snaphook	Steel Carabiner	\$157.99
3101226	Aluminum Snaphook	Single Leg	\$190.99
3101253	Steel Swiveling Snaphook	Single Leg	\$197.99



3101280



3101279

3500249

3500214

3500247

3500213

3500210

3500215

3500211



CLASS B

DBI SALA NANO-LOK EDGE 8' TWIN LEG SRL

Specifically designed for foot-level tie-off and sharp edge applications, ergonomically designed for comfort, integrated backpack-style energy absorber, easy-to-install connector provides 360 degrees of rotation, tough and flexible 3/16" galvanized cable lifeline, impact resistant housing, device reduces trip hazard, fall force, and fall clearance; other connectors available.

3500249 Aluminum rebar hook ends - \$499.99

DBI SALA NANO-LOK EDGE SINGLE LEG SRL

Built-in connector for single-leg SRL direct attachment to harness, stops fall within inches, ANSI compliant.

PART	END CONNECTOR	GATE OPENING	PRICE
3500214	Aluminum Captive Eye Carabiner	3/4"	\$291.99
3500247	Aluminum Rebar Hook	2-1/2"	\$277.99
3500213	Tie-Back	---	\$296.99
3500210	Steel Snaphook	3/4"	\$280.99
3500215	Aluminum Snaphook	1"	\$297.99
3500211	Steel Swiveling Snaphook	3/4"	\$291.99

MILLER SCORPION PERSONAL FALL LIMITERS

The lightweight, compact design of the Scorpion PFL provides workers an affordable alternative to shock absorbing lanyards. They offer greater mobility, safety, and versatility when compared to shock absorbing lanyards. Requires less fall clearance and prevents tripping hazards. Visual load indicator indicates when the unit must be removed from service. Quick-activating, high-strength stainless steel braking system. Attach it directly to the harness D-ring for use as a personal fall limiter, or use it as a traditional retractable lifeline. Variety of integral anchorage connectors available. Thermoplastic cover, aluminum extrusion, and polyester webbing. ANSI compliant.

CLASS
A

PFL-2-Z7/9FT PFL-4-Z7/9FT PFL-6-Z7/9FT PFL-7-Z7/9FT



PART	END CONNECTOR	UNIT CONNECTOR	PRICE
PFL-2-Z7/9FT	Steel Snaphook	Steel Carabiner	\$179.99
PFL-4-Z7/9FT	Steel Snaphook	Steel Carabiner & Swivel Shackle	\$199.99
PFL-6-Z7/9FT	Steel Snaphook	Steel Rebar Hook & Swivel Shackle	\$221.99
PFL-7-Z7/9FT	Steel Snaphook	Steel Snaphook & Swivel Shackle	\$234.99
PFL-9-Z7/9FT	Steel Rebar Hook	Steel Carabiner & Swivel Shackle	\$246.99
PFL-11-Z7/9FT	Steel Rebar Hook	Steel Snaphook & Swivel Shackle	\$242.99
PFL-15-Z7/9FT	Steel Swivel Snaphook	No Unit Connector	\$179.99

GUARDIAN DIABLO SRL 2.0

The new Diablo Self-Retracting Lifeline offers superior protection and its design makes it supremely lightweight and durable. It is available with steel or aluminum snaphooks or rebar hooks and can be purchased on its own or in a kit of two, which allows it to transform into a double unit. When the job requires a highly mobile and sturdy SRL, the Diablo is the perfect choice, available in 6' lengths. The Diablo Single SRL includes a carabiner and the Diablo Double SRL Kit includes a carabiner and connector bracket. When used in combination with proper PPE (i.e. harness and anchor), the Diablo SRL has a capacity range up to 420 lbs, ANSI compliant.

CLASS
A
VIDEO

11080 11081 11082 11083 11084



PART	END CONNECTOR	WEIGHT	PRICE
11080	Steel Snaphook	2.25 lbs	\$129.99
11081	Aluminum Snaphook	2 lbs	\$139.99
11082	Aluminum Rebar Hook	2.75 lbs	\$165.99
11083	Steel Rebar Hook	3.25 lbs	\$151.99
11084	Twin Steel Snaphooks	5.5 lbs	\$274.99
11085	Twin Aluminum Snaphooks	5.75 lbs	\$286.99
11086	Twin Aluminum Rebar Hooks	6.5 lbs	\$329.99
11087	Twin Steel Rebar Hooks	7.5 lbs	\$304.99

SAFEWAZE EXTREME WEB RETRACTABLES

The high strength polymer housing along with aluminum components make the 6' Dynema Webbing Extreme series one of the lightest SRD's available. This series comes in single and twin leg units with standard aluminum snaphooks, aluminum rebar hooks, or steel rebar hooks. Fall indicator incorporated into swivel top. Includes external shock absorber and unique braking system that eases shock in the event of a fall. 3,600 lbs gate-rated snap hook or rebar hook, tensile strength 5,000 lbs, capacity range up to 400 lbs. ANSI compliant.

CLASS
A

EX1006-W EX1006-W-RBH EX10065-W EX10065-W-RBH EX10065-W-RBH-BWB



PART	END CONNECTOR	PRICE
FS-EX1006-W	Aluminum Snaphook	\$190.00
FS-EX1006-W-RBH	Aluminum Rebar Hook	\$240.00
FS-EX10065-W	Twin Aluminum Snaphooks	\$390.00
FS-EX10065-W-RBH	Twin Aluminum Rebar Hooks	\$450.00
FS-EX10065-W-BWB	Twin Aluminum Snaphooks With Bracket	\$390.00
FS-EX10065-W-RBH-BWB	Twin Aluminum Rebar Hooks With Bracket	\$450.00



NEW
CLASS A
LE

GUARDIAN DIABLO BIG BLOCK LEADING EDGE CABLE SRL

Built with a special coated and heat treated brake pawl bolts. 3/16" galvanized wire rope, lightweight and heavy-duty housing, integrated shock absorber, carabiner included, man-rated 130-420 lbs, ANSI compliant.

10968 50' - \$644.99

10967 65' - \$679.99



CLASS B
LE

FALLTECH CONTRACTOR LEADING EDGE CABLE SRL

7/32" galvanized steel cable, internal inertial brake and external shock pack, glass-filled nylon housing, carabiner, load-indicating swivel carabiner, man-rated 310 lbs., ANSI compliant.

727630LE 30' - \$518.99

727650LE 50' - \$630.99



CLASS A
LE

GUARDIAN DIABLO GRANDE LEADING EDGE CABLE SRL

3/16" galvanized wire rope, compact and lightweight design, ergonomic handle, swivel top and swivel snap hook, carabiner included, man-rated 310 lbs, ANSI compliant.

42010 33' - \$565.99



CLASS B
LE

PROTECTA REBEL LEADING EDGE CABLE SRL

7/32" galvanized steel cable, swiveling self-locking snaphook, thermoplastic housing, fully integrated energy absorber, specially designed for foot level tie-off, carabiner included, ANSI compliant.

3590540 20' - \$528.99

3590543 33' - \$549.99



CLASS B
LE

MILLER MIGHTYLITE LEADING EDGE CABLE SRL

Shock absorber integrated into the lifeline, lowering fall arrest forces. Durable, corrosion-resistant aluminum and steel housing, man-rated 310 lbs, ANSI compliant.

RLS30G-Z7LE-30FT 30' - \$1,057.99



CLASS B
LE

DBI SALA ULTRA-LOK LEADING EDGE CABLE SRL

Delivers increased protection and safety when working near leading edges. 7/32" galvanized wire rope, thermoplastic housing, speed sensing brake, external energy absorber, man-rated 310 lbs, ANSI compliant.

3504500 30' - \$1,322.99



CLASS B
LE

GUARDIAN HALO LEADING EDGE CABLE SRL

Built with a special coated and heat treated brake pawl bolts. 3/16" galvanized wire rope, integrated shock absorber, carabiner included, man-rated 130-310 lbs, ANSI compliant.

10920 20' - \$596.99

10922 25' - \$618.99

10925 30' - \$641.99

ITEM	DESCRIPTION	LENGTH	CLASS	HOUSING	CAPACITY	RECERTIFIABLE	LEADING EDGE	PRICE
3590540	Protecta Rebel Leading Edge Cable SRL	20'	B	Thermoplastic	310 lbs		✓	\$528.99
10920	Guardian Halo Leading Edge Cable SRL	20'	B	Aluminum	310 lbs		✓	\$596.99
10922	Guardian Halo Leading Edge Cable SRL	25'	B	Aluminum	310 lbs	✓	✓	\$618.99
727630LE	FallTech Contractor Leading Edge Cable SRL	30'	B	Glass-Filled Nylon	310 lbs	✓	✓	\$518.99
10925	Guardian Halo Leading Edge Cable SRL	30'	B	Aluminum	310 lbs	✓	✓	\$641.99
3504500	DBI Sala Ultra-Lok Leading Edge Cable SRL	30'	B	Thermoplastic	310 lbs	✓	✓	\$1,322.99
RLS30G-Z7LE-30FT	Miller Mightylite Leading Edge Cable SRL	30'	B	Aluminum, Steel	310 lbs	✓	✓	\$1,057.99
42010	Guardian Diablo Grande Leading Edge Cable SRL	33'	A	Glass-Filled Nylon	310 lbs	✓	✓	\$565.99
3590543	Protecta Rebel Leading Edge Cable SRL	33'	B	Thermoplastic	310 lbs	✓	✓	\$549.99
10968	Guardian Diablo Big Block Leading Edge Cable SRL	50'	A	Glass-Filled Nylon	310 lbs	✓	✓	\$644.99
727650LE	FallTech Contractor Leading Edge Cable SRL	50'	B	Glass-Filled Nylon	310 lbs	✓	✓	\$630.99
10967	Guardian Diablo Big Block Leading Edge Cable SRL	65'	A	Glass-Filled Nylon	310 lbs	✓	✓	\$679.99



CLASS
B

PROTECTA REBEL RETRIEVAL CABLE SRL

3/16" stainless steel cable lifeline, aluminum housing, 3-way emergency retrieval system, speed sensing all metal brake system, internal energy absorption system, swiveling anchorage point and self-locking snap hook, man-rated 310 lbs, ANSI compliant.

3591001 50' - \$2,060.99



CLASS
B

FRENCH CREEK THREE WAY UNIT CABLE SRL

Galvanized steel cable, capable of raising or lower for rescue or retrieval, friction brake prevents crank hand from free-wheeling, aluminum housing, ANSI compliant.

R50G 50' - \$1,612.00



CLASS
B

ELK RIVER RESCUE & RECOVERY CABLE SRL

3/16" steel wire rope, composite housing, fall indicator, man-rated 310 lbs, ANSI compliant.

21970 50' - \$1,219.73



CLASS
B

MILLER MIGHTEVAC CABLE SRL WITH EMERGENCY HOIST

Lightweight and corrosion-resistant stainless steel/aluminum components, promotes quick and easy rescue with a 4:1 mechanical advantage, 310 lbs weight capacity, for emergency evacuation only, ANSI compliant.

MR50GB-Z7 50' - \$2,696.99

MR100GB-Z7 100' - \$3,254.99

MR130GB-Z7 130' - \$3,567.99

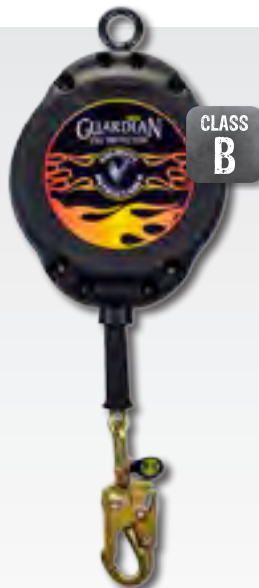

CLASS
B

GUARDIAN VELOCITY CABLE SRL

Glass-filled nylon housing, swivel top and swivel snaphooks, lightweight and durable, average arrest force: 900 lbs, maximum arrest force: 1,800 lbs, maximum deceleration distance: 54", ANSI compliant.

42003 50' - \$597.99

42004 80' - \$997.99

42005 100' - \$986.99



CLASS
B

SAFEVAZE EXTREME RETRACTABLE CABLE SRL

3/16" aircraft cable, heavy duty nylon housing with reinforced carrying handle and swivel top, 3,600 lbs gate-rated snaphook, unique breaking system that eases shock in the event of a fall, man-rated 310 lbs, ANSI compliant.

FS-EX1080G 80' - \$950.00

FS-EX10-100-G 100' - \$1,510.00



CLASS
B

FALLTECH 3-WAY RETRIEVAL CABLE SRL

3/16" galvanized steel cable, load-indicating swivel carabiner, durable aluminum housing, which mechanism can be activated for emergency rescue, mounting bracket, man-rated 310 lbs, ANSI compliant.

7283 60' - \$2,060.99



CLASS
B

**PROTECTA REBEL
CABLE SRL**

Rugged aluminum and steel construction, swiveling anchorage loop, Kevlar/Nomex covered external shock pack, swiveling snaphook, ANSI compliant.

3590019 15' - \$273.99



CLASS
B

NEW

**GUARDIAN HALO
BIG BLOCK
CABLE SRL**

3/16" galvanized cable with swivel top and high strength snaphook, stainless steel and aluminum components, dual braking mechanism, dual-swivel, ANSI compliant.

10917 50' - \$764.99

10918 65' - \$820.99



CLASS
B

NEW

**GUARDIAN HALO
CABLE SRL**

3/16" galvanized cable with carabiner, swivel top, snaphook, and tagline; durable aluminum housing, non-corrosive components, ANSI compliant.

10910 20' - \$424.99

10912 25' - \$457.99

10915 30' - \$560.99



CLASS
B

VIDEO

DBI SALA RSQ CABLE SRL WITH RESCUE

Dual-mode operation, prior to connection choose between fall arrest (requiring assisted rescue), or self rescue; fall arrest mode stops falls within inches - assisted rescue procedures can then be implemented either at the mode selector or remotely with an assisted rescue tool; self rescue mode automatically lowers the user to the next level, galvanized cable lifeline extends and retracts automatically enabling safe mobility, ANSI compliant.

3504550 50' - \$1,590.99

3500101 Assisted rescue tool - \$261.99



CLASS
B

**DBI SALA
SEALED BLOK CABLE SRL**

Galvanized steel cable, self-locking swivel snaphook with impact indicator, pivoting anchorage loop, aluminum housing, anti-ratcheting, ANSI compliant.

3400900 50' - \$1,805.99

3400860 85' - \$2,573.99

3400965 130' - \$3,540.99



CLASS
B

**DBI SALA
ULTRA-LOK CABLE SRL**

3/16" galvanized steel wire rope, self-locking swivel snaphook with impact indicator, anti-ratcheting twin disc brake system, ANSI compliant.

3504430 30' - \$1,070.99

3504450 50' - \$1,295.99

3504485 85' - \$1,538.99

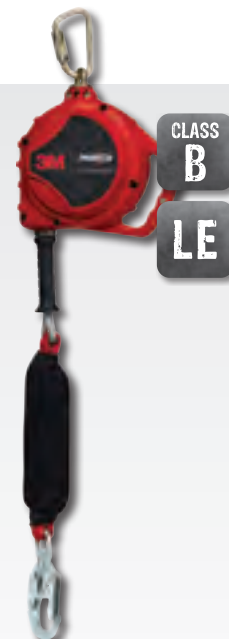

CLASS
B

LE

**PROTECTA REBEL
LEADING EDGE
CABLE SRL**

7/32" galvanized steel cable, swiveling self-locking snaphook, thermoplastic housing, fully integrated energy absorber, specially designed for foot level tie-off, carabiner included, ANSI compliant.

3590540 20' - \$528.99



CLASS B

PROTECTA REBEL WEB SRL

Self-retracting web lifeline with steel snaphook end, housing carabiner, rugged nylon thermoplastic housing, unique super-strength thin webbing, ANSI compliant.

3100425 11' - \$180.99
3100431 20' - \$339.99



CLASS B

NEW

GUARDIAN HALO WEB SRL

Swiveling carabiner top and snaphook end, ergonomic frame makes handling more comfortable, durable aluminum housing, stainless steel and non-corrosive components, quick-action braking system, ANSI compliant.

10900 11' - \$132.99
10901 11' With rebar hook - \$205.99



CLASS B

GUARDIAN VELOCITY WEB SRL

Swiveling top with carabiner and steel snaphook end, durable and lightweight glass-filled nylon housing, polyester webbing, ANSI compliant.

42006 20' - \$318.99
42008 40' - \$370.99



CLASS B

ELK RIVER JAGUAR WEB SRL

3/4" Dyneema webbing, carabiner and tagline included, swivel Z snaphook 3.6 m gate with fall indicator, PC / ABS case, recertifiable, carry handle attachment available, ANSI compliant.

22426 26' - \$345.99



CLASS B

CUSTOMER CHOICE

FALLTECH DYNEEMA CONTRACTOR WEB SRL

High strength, superior cut, and abrasion resistant Dyneema webbing, load-indicating swivel carabiner and connecting carabiner with 3,600 lb gate, lightweight aluminum drum center and ABS plastic housing, ANSI compliant.

7276WR 20' - \$264.99

ITEM	DESCRIPTION	LENGTH	CLASS	HOUSING	CAPACITY	RECERTIFIABLE	LEADING EDGE	PRICE
MRG3-0Z	French Creek Rogue Web SRL	9'	A	Thermoplastic	400 lbs			\$159.99
PFL-2-Z7	Miller Scorpion PFL Web SRL	9'	A	Thermoplastic & Aluminum	400 lbs			\$168.99
PFL-4-Z7	Miller Scorpion PFL Web SRL	9'	A	Thermoplastic & Aluminum	400 lbs			\$191.99
10946	Guardian Velocity Web SRL	10'	B	Thermoplastic	420 lbs			\$399.99
10900	Guardian Halo Web SRL	11'	B	Aluminum	310 lbs			\$129.99
3100425	Protecta Rebel Web SRL	11'	B	Thermoplastic	310 lbs			\$180.99
10901	Guardian Halo Web SRL	11'	B	Aluminum	310 lbs			\$205.99
RG3-13-0Z	French Creek Renegade Web SRL	13'	B	Thermoplastic	400 lbs			\$169.99
7276WR	FallTech Dyneema Contractor Web SRL	20'	B	Thermoplastic	310 lbs			\$264.99
42006	Guardian Velocity Web SRL	20'	B	Glass-Filled Nylon	310 lbs			\$318.99
3100431	Protecta Rebel Web SRL	20'	B	Thermoplastic	310 lbs			\$339.99
22426	Elk River Jaguar Web SRL	26'	B	Thermoplastic	310 lbs	✓		\$345.99
42008	Guardian Velocity Web SRL	40'	B	Glass-Filled Nylon	310 lbs	✓		\$370.99



CLASS
A

VIDEO

**WESTFALL PRO
SKYLOK II CABLE SRL**

Lightweight, fiberglass reinforced, stackable nylon housing; double-locking steel swivel snaphook; swivel connection; rubberized, form-fitted cable grip; load-bearing steel frame; exceeds Class A ANSI & OSHA requirements.

67030 30' - \$399.99

67050 50' - \$449.99

67100 100' - \$799.99



CLASS
B

CUSTOMER
CHOICE

**PROTECTA REBEL
CABLE SRL**

3/16" galvanized steel cable, shock-resistant thermoplastic housing, self-locking swivel snaphook with impact indicator, ANSI compliant.

3590500 33' - \$458.99

3590550 50' - \$619.99

3590630 85' - \$1,047.99

3590670 100' - \$1,263.99



CLASS
A

**GUARDIAN DIABLO
GRANDE CABLE SRL**

Galvanized cable lifeline with ergonomic handle, swivel top and swivel snaphook, ANSI compliant.

42009 33' - \$452.99

**42010 33' Leading edge,
nylon coating with integrated
shock absorber - \$565.99**

ITEM	DESCRIPTION	LENGTH	CLASS	HOUSING	CAPACITY	RECERTIFIABLE	LEADING EDGE	PRICE
3590019	Protecta Rebel Cable SRL	15'	B	Nylon Thermoplastic	310 lbs			\$273.99
42000	Guardian Velocity Cable SRL	16'	B	Glass-Filled Nylon	420 lbs			\$378.99
727620	FallTech Cable Contractor Cable SRL	20'	B	Glass-Filled Nylon	310 lbs			\$361.99
42001	Guardian Velocity Cable SRL	20'	B	Glass-Filled Nylon	310 lbs			\$388.99
10910	Guardian Halo Cable SRL	20'	B	Aluminum	420 lbs			\$424.99
10912	Guardian Halo Cable SRL	25'	B	Aluminum	420 lbs	✓		\$457.99
727630	FallTech Cable Contractor Cable SRL	30'	B	Glass-Filled Nylon	310 lbs	✓		\$465.99
42002	Guardian Velocity Cable SRL	30'	B	Glass-Filled Nylon	310 lbs	✓		\$360.99
67030	WestFall Pro Skylok II Cable SRL	30'	A	Fiberglass Reinforced Nylon	310 lbs	✓		\$399.99
10915	Guardian Halo Cable SRL	30'	B	Aluminum	420 lbs	✓		\$560.99
3504430	DBI Sala Ultra-Lok Cable SRL	30'	B	Glass-Filled Polyurethane	310 lbs	✓		\$1,070.99
42009	Guardian Diablo Grande Cable SRL	33'	A	Glass-Filled Nylon	420 lbs	✓		\$452.99
3590500	Protecta Rebel Cable SRL	33'	B	Nylon Thermoplastic	420 lbs	✓		\$458.99
67050	WestFall Pro Skylok II Cable SRL	50'	A	Fiberglass Reinforced Nylon	310 lbs	✓		\$449.99
727650	FallTech Cable Contractor Cable SRL	50'	B	Glass-Filled Nylon	310 lbs	✓		\$546.99
42003	Guardian Velocity Cable SRL	50'	B	Glass-Filled Nylon	310 lbs	✓		\$597.99
3590550	Protecta Rebel Cable SRL	50'	B	Nylon Thermoplastic	420 lbs	✓		\$619.99
10917	Guardian Halo Big Block Cable SRL	50'	B	Aluminum	420 lbs	✓		\$689.99
3504450	DBI Sala Ultra-Lok Cable SRL	50'	B	Urethane Thermoplastic	310 lbs	✓		\$1,295.99
3504550	DBI Sala RSQ Cable SRL With Rescue	50'	B	Urethane Thermoplastic	310 lbs	✓		\$1,590.99
3400900	DBI Sala Sealed Blok Cable SRL	50'	B	Aluminum, Stainless Steel	420 lbs	✓		\$1,805.99
10918	Guardian Halo Big Block Cable SRL	65'	B	Aluminum	420 lbs	✓		\$820.99
42004	Guardian Velocity Cable SRL	80'	B	Glass-Filled Nylon	310 lbs	✓		\$997.99
3590630	Protecta Rebel Cable SRL	85'	B	Nylon Thermoplastic	420 lbs	✓		\$1,047.99
3504485	DBI Sala Ultra-Lok Cable SRL	85'	B	Aluminum	310 lbs	✓		\$1,538.99
3400860	DBI Sala Sealed Blok Cable SRL	85'	B	Aluminum, Stainless Steel	420 lbs	✓		\$2,573.99
67100	WestFall Pro Skylok II Cable SRL	100'	A	Fiberglass Reinforced Nylon	310 lbs	✓		\$799.99
42005	Guardian Velocity Cable SRL	100'	B	Glass-Filled Nylon	310 lbs	✓		\$986.99
3590670	Protecta Rebel Cable SRL	100'	B	Nylon Thermoplastic	420 lbs	✓		\$1,263.99
3400965	DBI Sala Sealed Blok Cable SRL	130'	B	Aluminum, Stainless Steel	420 lbs	✓		\$3,540.99



DOUBLE LOCKING WITH STEEL SWIVEL CONNECTOR

INNOVATION IN FALL PROTECTION

FIBERGLASS
REINFORCED NYLON
HOUSING WITH
RUBBERIZED
CARRYING HANDLE

AVAILABLE IN 30',
50' & 100' LENGTHS

SWIVELING SNAPHOOK

SKYLOC II SRL

- Load-bearing steel frame
- Over-sized steel anchor swivel
- Patented, non-centrifugal Fail-Safe locking mechanism
- Lightweight and incredibly rugged
- Stackable for efficient storage
- Exceeds the Class A requirements of ANSI Z359.14
- Exceeds the requirements of OSHA 1910 and 1926

573-355-5470 WWW.WESTFALLPRO.COM

**WESTFALL
PRO**



WESTFALL PRO DYNEEMA ANCHOR SLING WITH RING

3/4" Dyneema web construction for weight savings and extra durability, aluminum O-ring for pass-thru anchorage, heavy-duty label cover to protect inspection and product information, rated for one 310 lb user. Meets ANSI Z359.1 and OSHA 1926.502.

- 711601 17" - \$27.99
- 711602 24" - \$32.99
- 711603 36" - \$41.99
- 711606 72" - \$66.99



FALLTECH WEB PASS-THRU ANCHOR

Heavy-duty 1-3/4" polyester webbing with rugged forged alloy-steel hardware, 3" wear pad protects primary webbing from cuts and abrasion, ideal for I-beams and other properly rated structural members.

- 7324 1-3/4" x 2' - \$26.99
- 7336 1-3/4" x 3' - \$29.99
- 7348 1-3/4" x 4' - \$31.99
- 7372 1-3/4" x 6' - \$37.99



GUARDIAN PREMIUM CROSS ARM STRAP

Twice as durable with dual enforced webbing and heavy-duty stitching, heavy-duty wear pad protects the structural webbing against abrasion and snags, large D-ring and standard size D-ring for pass-thru.

- 10785 3' - \$20.99
- 10786 4' - \$22.99
- 10787 6' - \$31.99
- 10788 8' - \$35.99
- 10790 10' - \$39.99



ELK RIVER EZE-MAN SLING

Triangle end / D-ring end.

- 26772 1-3/4" x 2' - \$34.99
- 26773 1-3/4" x 3' - \$34.99
- 26774 1-3/4" x 4' - \$35.99
- 26776 1-3/4" x 6' - \$35.99



GUARDIAN SINGLE USE CONCRETE ANCHOR STRAP

Inexpensive anchor solution; disposable and intended for one time use only; make sure that anchor strap is attached to a structure capable of supporting 5,000 lbs; sheathed in heavy duty nylon webbing.

- 10710 3' - \$6.99
- 10715 4' - \$8.99
- 10717 6' - \$10.99



PROTECTA WEB TIE-OFF ADAPTOR

Pass-thru type tie-off adaptor, durable polyester construction, abrasion resistant polyester wear pad, high-strength steel hardware, compact and lightweight design.

- 5900576 2' - \$21.99
- 5900577 3' - \$22.99
- 5900578 6' - \$24.99
- 5900579 8' - \$27.99
- 5900580 12' - \$47.99
- 5900581 16' - \$55.99
- 5900582 20' - \$68.99



PROTECTA CABLE TIE-OFF ADAPTOR

Cable pass-thru choker, durable 1/4" (6.3 mm) 7" x 19" galvanized steel cable with vinyl jacket, compact and lightweight design, high-strength steel O-rings at both ends.

- AJ47406 6' - \$45.99
- AJ408AG Attachment ring one end, snaphook other end - \$60.99



BLUEWATER RHINO ANCHOR LOOP SLINGS

BlueWater Rope's Dual Sheath Armortech construction essentially creates a loop inside a loop; yellow outer for high visibility; fluorescent orange inner webbing to alert users of cuts or abrasions; custom Dyneema thread make overlap of sewn closure 1/3 the length of other slings; end to end: 11,000 lbf; choker: 10,000 lbf; basket: 15,000 lbf. Other lengths also available.

- 757002 24" - \$14.00
- 757003 36" - \$15.50
- 757004 48" - \$17.00



DBI SALA WEB TIE-OFF ADAPTOR

Pass-thru type tie-off adaptor, durable polyester construction, abrasion resistant polyester wear pad, high-strength steel hardware, compact and lightweight design.

- 1003000 3' - \$49.99
- 1003006 6' - \$56.99



GUARDIAN SWIVEL CONCRETE ANCHOR KIT

Kit includes a visual indicator so that you can see when it has been installed correctly. Made from galvanized steel and stainless steel, rotates 180° for mobility, can be used in a variety of environments for temporary and permanent applications.

00242 - \$128.99



GUARDIAN TWO-WAY UNIVERSAL STANDING SEAM ROOF CLAMP

Lightweight, reusable, durable, and easy-to-use. The clamp also features a unique, reversible design that allows for seams up to 1" wide. The MR-24, VSR or similar profiles can be covered with one clamp.

10600 - \$205.99



FALLTECH BOLT-ON D-RING ANCHOR PLATE

5,000 lbs minimum breaking strength, can be mounted vertically or horizontally to steel by welding on or by using grade 5 or better hardware.

7414 - \$23.99

7414SS Stainless steel plate - \$32.99

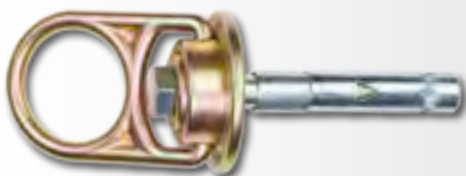

PMI MEGA SWIVEL ANCHOR

Ultimate breaking strength of 10,000 lbs, made from zinc plated alloy steel, designed to be used in concrete or steel, D-ring rotates 360 degrees and flips 180 degrees, ANSI compliant.

HD26227 For concrete - \$79.99

HD26226 For steel - \$70.99



ELK RIVER EAGLE TIE-OFF SLING

Wear pad is made from nylon, features a 4" half loop eye on each end, man-rated to 310 lbs, 1" wide x 3' long.

63673 36" - \$18.99



GUARDIAN RIDGE-IT SAFU ANCHOR

Made of stainless steel, the SAFU Anchor has a D-ring on each end. Compliant with all OSHA and ANSI standards. For permanent installation on wood rooftops. Manufactured with butyl strips, the SAFU is waterproof and includes fasteners.

00510 18" - \$36.99



DBI SALA SCAFFOLD CHOKER ANCHOR

1" polyester strength member (5,000 lb. Min. tensile strength), fits 3" maximum diameter structure, coated steel hardware for corrosion resistance and strength, OSHA and the stringent ANSI Z359 compliant.

1201390 17" - \$27.99



PMI 3' ROLLER SLING

ANSI Z359 certified anchorage connector with sealed ball bearing rollers and spaces for ease while working on bridges or around pipe where other anchor points aren't prevalent. Steel carabiner not included. 5,000 lbs breaking strength.

HD26247 - \$220.40

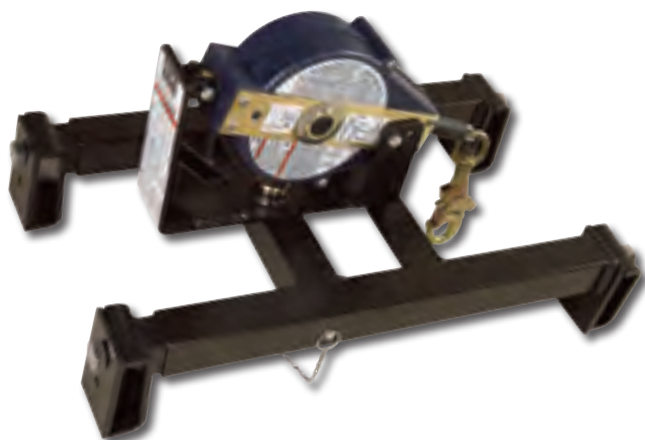

DBI SALA STANDING SEAM ROOF ANCHOR

Swiveling design provides 360 degree mobility, installs in minutes with no special tools, portable design, reusable on sloped or flat structural standing seam roofs, designed to be used with Ultra-Lok self retracting lifelines (not included), telescoping adjustment legs fit 24", 30", 32", and 36" seam spacing.

2103675 - \$499.99



PROTECTA STANDING SEAM ROOF ANCHOR FOR SRL

Installs to flat or sloped standing seam roofs, non-penetrating design won't damage the roof, adjustable legs fit 12" and 24" seam spacing, built-in swiveling self retracting lifeline bracket (order SRL separately), durable and corrosion resistant construction, compact and lightweight design, portable and reusable.

2190001 - \$330.99



GUARDIAN TRUSS BOSS ANCHOR

Made from galvanized steel this anchor can be installed upright or inverted. Easy to install, lightweight, and a worker capacity range of 130-420 lbs.

00432 - \$35.70



GUARDIAN PERMANENT ADJUSTABLE STANDING SEAM ROOF ANCHOR

Utilizes S-5 clamps, manufactured from lightweight, durable aluminum, compatible with seams from 12"- 24" apart, can be used in either permanent or temporary installation applications.

00249 - \$376.99



GUARDIAN HITCHCLIP

Made from lightweight and durable powder-coated aluminum, the HitchClip is easy to install, and functions as a permanent rooftop anchor. Thanks to its patent pending "key-hole" design, the HitchClip can be used in combination with a large variety of accessories, allowing it to be used to set up guardrail systems, staging areas, and more.

10560 3 pack - \$51.99

10566 25 pack - \$411.99



GUARDIAN TEMPER REUSABLE ROOF ANCHOR

Reusable anchorage connector designed for temporary use on wood rooftops, fits all roof pitches from flat to 12/12, composed of thick plated steel for longer lasting product life, can be installed with either screws or duplex nails (depending on roof pitch), designed offset holes down the center.

00455 - \$22.99



CUSTOMER CHOICE

FRENCH CREEK PARAPET WALL ANCHOR

Designed to provide a single worker with a portable, temporary anchorage on parapet walls up to 20" thick. Applications include window washing, construction, emergency & rescue situations, and more. Features one padded fixed leg and one padded adjustable leg (with multiple pin sets & adjustable mounting pad), the unit can be sized and secured without the use of tools.

1789 - \$294.99

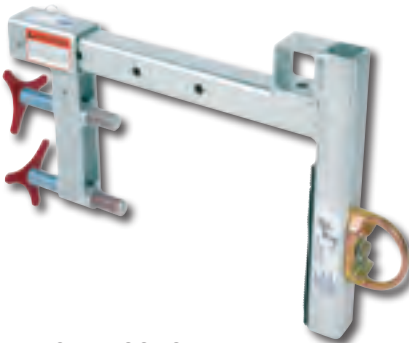

DBI SALA CONCRETE PARAPET WALL ANCHOR

Portable anchorage connector was designed for fall arrest applications and developed to be used in locations where a low parapet wall provides an anchor site. Non-penetrating design does not penetrate the working surface reducing the possibility of damage, adjustment range 1" to 14.5" wide, no tools required for installation, can be used with a shock absorbing lanyard or self retracting lifeline.

8523178 - \$763.99



VIDEO

GUARDIAN BEAMER 2000

Designed specifically for use at your feet and overhead, nylon bushings provide smooth movement, lightweight, glides easily in both directions, welding spatter does not stick to aluminum bar, no tools necessary for fast installation, one-handed operation.

00101 - \$134.99



GUARDIAN O-TORQUE VERTICAL BEAMER

Installs vertically or horizontally, compatible with I or H steel beams, can be used as an anchorage connector or as an anchor in horizontal lifeline systems, fits beams 4-1/2" to 12" wide and 1/2" to 2" thick.

00141 - \$204.95



GUARDIAN HOLLOW CORE CONCRETE ANCHOR

Easy to install in both concrete and steel substrates, lightweight and durable, hollow core anchor, for 3/4" diameter hole, and can withstand loads up to 5,000 lbs.

00365 - \$215.99



GUARDIAN BOLT HOLE ANCHOR

Reusable 5,000 lb anchor point, easy to install, no tools required, fits holes 3/8" to 1 1/4", can be used vertically or horizontally, squeeze to twist lock, release to activate lock.

00230 - \$138.99



GUARDIAN PORTABLE CONCRETE ANCHOR CONNECTOR

5,000 lb fall arrest rated, provides portable and safe anchorage for horizontal, vertical, and overhead surfaces, ANSI compliant.

00235 - \$102.99



DBI SALA ROOF TOP FREESTANDING COUNTERWEIGHT ANCHOR

Freestanding counterweight anchor with (16) plates weighing 45 lbs (20 kg) each, includes (4) PVC-coated base plates, installs to flat or up to 5 degree sloped roofs, non-penetrating design simply sits on working surface, built-in shock absorbing system for added safety, integral carrying handles for easy transport, compatible with various fall arrest connecting systems, portable and reusable.

2100185 - \$3,287.99

GUARDIAN BEAMER 2000+

Drawing from the already superior features of the Beamer 2000, the 2000+ offers a D-ring that both pivots and swivels, adjustment levers at the top of the anchor instead of the side to reduce the likelihood of accidental impact adjusters, and weighs lighter. Perfect for a wide range of fall protection needs when working with structural steel I-beams.

00102 - \$173.99



DBI SALA GLYDER2 BEAM ANCHOR

Provides complete horizontal mobility, tie-off overhead or at feet using a Force2 shock absorbing lanyard, effortlessly slides across the beam on its wear pads eliminating metal-to-metal contact, fits flange 3-1/2" to 14" wide and up to 1-1/4" thick.

2104700 - \$219.99



GUARDIAN MINOTAUR GIANT I BEAMER

An anchorage connector that is lightweight and adjustable, capability to fit on much larger beams compared to similar models, dual adjustability for use with beams 14" to 30" in width, and has a 420 lb worker capacity.

00106 - \$334.99



WESTFALL PRO BEAM ANCHOR

Made from aircraft aluminum the beam anchor is lightweight, features a swivel D-ring on top, and is removable and reusable, fits flange 3-1/2" to 12", 5,000 lbf breaking strength, 22 kN, 310 lbs weight capacity, ANSI compliant.

7005 - \$149.99



DBI SALA TROLLEY FOR I-BEAM

Installs onto 3"-8" wide I-beam flange up to 11/16" thick, ideal for use with self retracting lifeline on horizontal beams, rotating D-ring tie-off point is fixed in center, double-shielded wheel bearings, attachable anywhere along beam including midpoint, built-in guards protect wheels, dual adjustment dials are fixed to trolley for precise alignment in 1/8" increments, trolley guards protect the wheels from damage and keeps beam clear of debris, meets or exceeds all applicable industry standards including OSHA, ANSI and the stringent ANSI Z359.

2103143 - \$447.99



GUARDIAN
FALL PROTECTION SYSTEMS

GUARDIAN ANGEL ANCHOR SYSTEM

Ideal solution for a versatile single tie-off point when penetrating the substrate is not an option, newly designed 3-piece "spine" makes it easier to transport and assemble, allows for the anchor to be used on surfaces up to a 5° slope, corrosion resistant, durable, and designed for use by a person weighing up to 310 pounds (including all equipment).

00260 - \$2,469.99





WestFall Professional products are designed to meet and exceed the most stringent of industry standards. Using the latest innovation and technology, WestFall delivers specialized products you and your team can depend on. Choose from WestFall's large selection of rugged hardware, guaranteed to keep you safe.



07440



07430



07425



07420

VIEW OUR
ENTIRE SELECTION
ONLINE AT
GMESUPPLY.COM



07405



07410



07437



07436



07435

PART	DESCRIPTION	LENGTH	WIDTH	GATE	MBS	CERTIFICATION	PRICE
07440	WestFall Pro Steel Carabiner	8-5/8"	5-1/8"	2"	35 kN	ANSI Z359-12-2009	\$39.99
07430	WestFall Pro Steel Carabiner	7-1/2"	4-1/2"	2-1/4"	45 kN	ANSI Z359-12-2009	\$37.99
07425	WestFall Pro Steel Carabiner	7-1/8"	4-1/2"	1-1/8"	50 kN	ANSI Z359-12-2009	\$27.99
07420	WestFall Pro Steel Carabiner	7"	3-3/4"	1-3/4"	35 kN	ANSI Z359-12-2009	\$28.99
07405	WestFall Pro Steel Carabiner	4-1/2"	2-3/4"	3/4"	41 kN	ANSI Z359-12-2009	\$21.99
07410	WestFall Pro Steel Carabiner	3-1/4"	1-1/8"	1/2"	30 kN	ANSI Z359-12-2009	\$19.99
07437	WestFall Pro Aluminum Carabiner	4-7/8"	3"	13/16"	23 kN	ANSI Z359-12-2009	\$27.99
07436	WestFall Pro Aluminum Carabiner	4-7/8"	3-1/8"	7/8"	30 kN	ANSI Z359-12-2009	\$27.99
07435	WestFall Pro Aluminum Carabiner	4-3/4"	3"	9/10"	25 kN	ANSI Z359-12-2009	\$24.95

All hardware photos are proportionately scaled.



PART	DESCRIPTION	LENGTH	WIDTH	GATE	MBS	CERTIFICATION	PRICE
07400	WestFall Pro Steel Carabiner	4-7/8"	3-1/8"	1-1/16"	45 kN	ANSI Z359-12-2009	\$21.99
07401	WestFall Pro Steel Carabiner	4-7/8"	3"	1"	50 kN	ANSI Z359-12-2009	\$23.99
07445	WestFall Pro Stainless Steel Carabiner	4-1/2"	2-1/2"	1"	23 kN	ANSI Z359-12-2009	\$42.99
07460	WestFall Pro Aluminum Carabiner	8-5/8"	5-1/8"	1-1/5"	25 kN	ANSI Z359-12-2009	\$52.95
07465	WestFall Pro Snaphook	5"	2-1/4"	3/4"	23 kN	ANSI Z359-12-2009	\$15.50
07466	WestFall Pro Swivel Snaphook	7-1/16"	2-1/4"	3/4"	23 kN	ANSI Z359-12-2009	\$32.99
07475	WestFall Pro Separator Spreader Bar Snaphook	9-3/4"	2-1/4"	3/4"	22.2 kN	ANSI Z359-12-2009	\$34.99
13450	Elk River Separator Spreader Bar Snaphook	9-3/4"	2-1/4"	3/4"	22.2 kN	ANSI Z359-12-2009	\$29.99
07450	WestFall Pro Rebar Hook	9"	4-2/3"	2-1/2"	23 kN	ANSI Z359-12-2009	\$32.99
07455	WestFall Pro Swivel Rebar Hook	11-1/4"	5-1/8"	2-1/2"	23 kN	ANSI Z359-12-2009	\$47.99
07452	WestFall Pro Steel Rebar Hook	9-3/5"	5-3/20"	2-11/20"	23 kN	ANSI Z359-12-2009	\$35.99
07451	WestFall Pro Aluminum Rebar Hook	9-4/5"	5-3/10"	2-1/2"	23 kN	ANSI Z359-12-2009	\$39.99

* All hardware photos are proportionately scaled. These Non-ANSI rated connectors are not rated to be used in a fall arrest system in the tower climbing industry, although they may be acceptable in other industries.



C81A



C82A



C1A



C2A



C3A



M36A-SL



M34A-RL



M33-TL



SM103100N



HWSAFEDTL

PART	DESCRIPTION	LENGTH	WIDTH	GATE	MBS	PRICE
C81A	Rock Exotica SwivaBiner Auto Lock Aluminum Carabiner	7.3"	2.6"	0.84"	30 kN	\$88.99
C82A	Rock Exotica SwivaEye Auto Lock Aluminum Carabiner	5.4"	2.6"	0.84"	30 kN	\$78.99
C1A	Rock Exotica Pirate Auto Lock Aluminum Carabiner	4.2"	2.8"	1"	26 kN	\$18.99
C1A-B	Rock Exotica Black Pirate Auto Lock Aluminum Carabiner	4.2"	2.8"	1"	26 kN	\$19.99
C2A	Rock Exotica RockD Auto Lock Aluminum Carabiner	4.5"	2.7"	0.95"	29 kN	\$19.99
C2A-B	Rock Exotica Black RockD Auto Lock Aluminum Carabiner	4.5"	2.7"	0.95"	29 kN	20.99
C3A	Rock Exotica RockO Auto Lock Aluminum Carabiner	4.4"	2.5"	0.9"	24 kN	\$19.99
C3A-B	Rock Exotica Black RockO Auto Lock Aluminum Carabiner	4.4"	2.5"	0.9"	24 kN	\$20.99
M36A-SL	Petzl William Screw Lock Aluminum Carabiner	4.6"	3.1"	1.1"	27 kN	\$16.95
M34A-RL	Petzl Am'D Twist Lock Aluminum Carabiner	4.3"	2.5"	0.98"	27 kN	\$19.95
M33-TL	Petzl OK Triact Lock Aluminum Carabiner	3.9"	2.8"	0.75"	24 kN	\$23.95
SM103100N	SMC Kinetic Dual Lock Carabiner	4.6"	2.9"	0.98"	28 kN	\$19.95
HWSAFEDTL	Sterling Rope SafeD Twist Lock Carabiner With Lanyard Pin	4.4"	2.5"	1.05"	28 kN	\$30.99

CONNECTORS 101

COMPLIANCE
This stamp clearly identifies the standard which the hardware is manufactured to follow. Typically ANSI Z359.1-2007 or Z359.12, although there may also be CSA or EN ratings stamped, as well.

LOAD RATING
A load rating should be stamped on the long axis of the hardware. This shows what the minimum break strength of the hardware is, typically displayed in pounds, tons, or kN.

MANUFACTURER MARKINGS
ID's who made the hardware, lot #'s and other codes to help identify when, where, and who made the thing. These aren't as much as a safety feature, as they are for troubleshooting if there's ever a bad batch from the manufacturer.

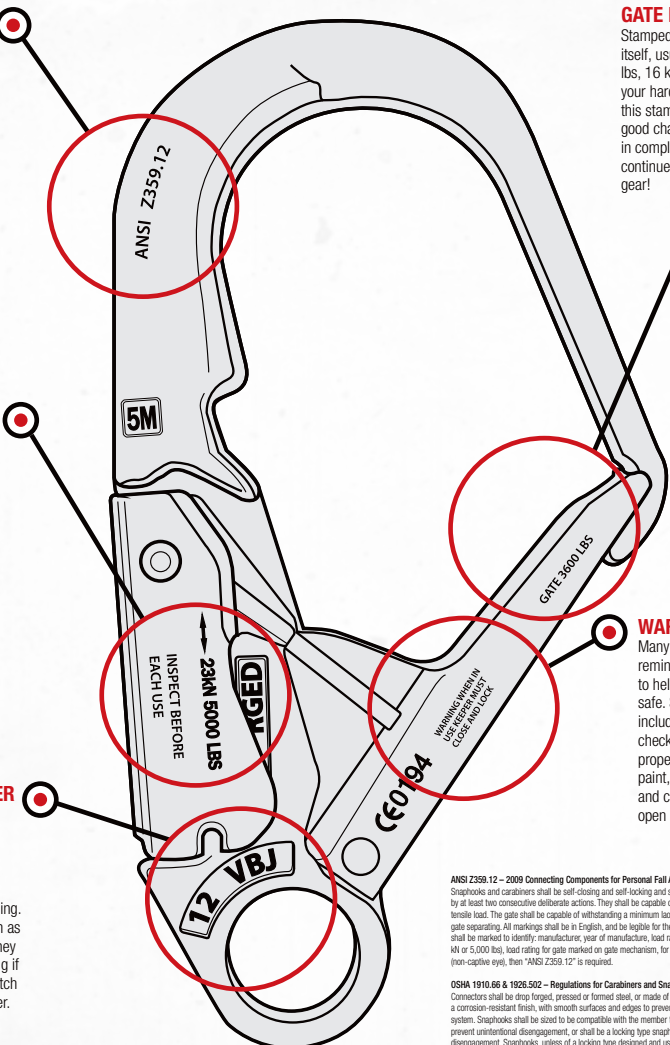

GATE RATINGS
Stamped on the gate itself, usually as 3,600 lbs, 16 kN or 3.6 m. If your hardware is missing this stamp, there's a good chance you're not in compliance. Don't continue work with this gear!

WARNINGS
Many manufacturers put reminders or warnings to help the user stay safe. Some examples include: a note to double check the gate is closed properly, red warning paint, or even a skull and cross bones logo for open gates.

ANSI Z359.12 – 2009 Connecting Components for Personal Fall Arrest Systems
Snaphooks and carabiners shall be self-closing and self-locking and shall be capable of being opened only by at least two consecutive deliberate actions. They shall be capable of withstanding a 5,000 lbs. (22,240) tensile load. The gate shall be capable of withstanding a minimum load of 3,600 lbs (164N) without the gate separating. All markings shall be in English, and be legible for the life of the component. Connectors shall be marked to identify manufacturer, year of manufacture, load rating for major axis (minimum of 22 kN or 5,000 lbs), load rating for gate mechanism, for connectors that are non-integral part (non-captive eye), then "ANSI Z359.12" is required.

CSA 1910.66 & 1926.502 – Regulations for Carabiners and Snaphooks
Connectors shall be drop forged, pressed or formed steel, or made of equivalent materials. They shall have a corrosion-resistant finish, with smooth surfaces and edges to prevent damage to interfacing parts of the system. Snaphooks shall be sized to be compatible with the member to which they are connected so as to prevent unintentional disengagement, or shall be a locking type snaphook designed and used to prevent disengagement. Snaphooks, unless of a locking type designed and used to prevent disengagement from the following connections, shall not be engaged: directly to webbing, rope or wire rope; to each other; to a D-ring to which another snaphook or other connector is attached; to a horizontal lifeline; or to any other edges which is incompatibly shaped or dimensioned in relation to the snaphook such that the connected object could depress the snaphook keeper a sufficient amount to release itself.

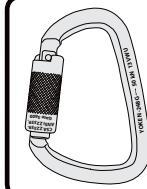

GEOMETRY
During normal work, connectors move around on anchorage points. If your hardware isn't designed to be used with your anchorage point, or doesn't have proper safety features, the gate could make contact with the anchorage point and potentially work its way open. Be sure your connector and anchorage point are compatible. This risk is magnified when the connection is at foot level.

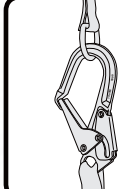

TENSION DIRECTION
Snaphooks and carabiners are designed to be loaded on their long axis. Loading them incorrectly may lead to failure. Always be sure your hardware is being loaded in the proper direction. If you're at risk of cross loading, or applying tension on the short axis, don't continue working.

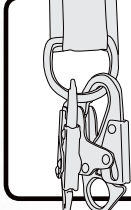

ONE AT A TIME
Connectors are designed to go solo. Attaching two snaphooks or carabiners to a single D-ring may cause problems. They can act on each other causing one to slip open, or get twisted up, causing damage. Remember, one per anchorage point!

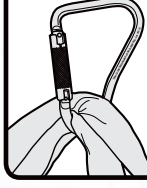

LOAD RATING
Hardware made for lifting and rigging will have a Working Load Limit, often abbreviated as WLL on the hardware, stamped in the metal. This means the hardware has been tested to be able to maintain a static load up to that rating. This rating can be listed in lbs, tons, or even kN. Don't use carabiners designed for fall protection for lifting and rigging!

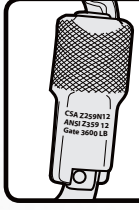

ANSI
ANSI Z359 compliant connectors are almost universally recommended. Hardware that has this standard will have gates rated to 3,600 lbs. This helps ensure the gate will not fail if loading occurs. Multi-action gates are also required. To open, there must be at least two separate actions made to release the mechanism. Look for the ANSI stamp before using the gear.

INSPECTING CONNECTORS

GATE FUNCTION
Check the gate for smooth operation. It should open smoothly. When released, it should close and lock properly. When closed, move gate back and forth to see if there is excess movement. If it catches, grinds, doesn't close properly, or is difficult to operate, remove the unit from service.

DEFORMITY
Check the axis of the unit for signs of overloading or deformity. Any stretching, or stress marks warrant removal from service.

RUST/CORROSION
Look over the unit for any signs of corrosion or rust. ANSI Z359 connectors use a zinc coating for protection that wears off during normal use. Once the zinc begins to show signs of pitting or corrosion remove from service.

MARKINGS
If any of the ratings normally stamped on the hardware are worn off, the unit must be retired.

PHYSICAL DAMAGE
Inspect for any significant dents, nicks, cuts or gouges to the carabiner or snaphook. These can be indications of improper use.

THE MANY SHAPES, FUNCTIONS, AND DESIGNS OF CONNECTORS

There are many designs of connectors. From all the different shapes and materials of carabiners, to snaphooks and rebar hooks. Some have swivels, some have double and even triple action locking mechanisms. Made from steel, aluminum, or other alloys, they can be designed for fall protection, lifting and rigging, or maybe just to quickly connect two objects and not made for safety at all. Be sure you have the proper piece of hardware for the job at hand... if you're not sure, give our Gear Experts® a call and we'll make sure you're in the clear!



VIDEO

PURCHASE THE 19" x 27" POSTER FOR

\$14.95

PART # 2202

ROPE 101

ROPE CONSTRUCTION

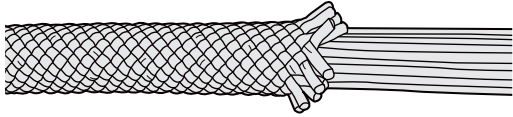

Kernmantle (Pages 63-64) - Kernmantle rope consists of twisted parallel fibers (the kern) surrounded by a tightly braided sheath (the mantle). The core fibers provide the majority (about 70%) of the rope's strength. The sheath is tightly braided providing significantly higher abrasion resistance. There are two distinct types of kernmantle: dynamic and static. Dynamic is used for recreational climbing due to its high shock absorption capabilities. Static kernmantle has very low stretch and works well for industrial applications. Due to its construction, it remains round through descent devices and allows minimal twist on the rope. The properties of static kernmantle make it ideal for use as a life line or descent line.

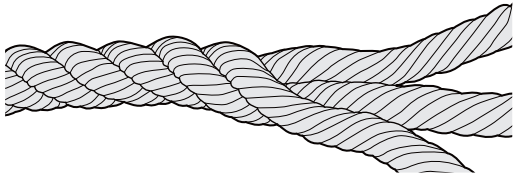

3-Strand (Page 67) - 3-Strand ropes are an inexpensive rope option. They tend to have a lower breaking strength than double braid or kernmantle, so a larger diameter must be used to achieve the same strength. Due to their construction, 3-Strand ropes have a tendency to rotate under load and provide less abrasion resistance. These characteristics make it a poor load line. With regard to safety and working at height, 3-Strand is most commonly used as a lifeline due to compliance with OSHA requirements and compatibility with 5/8" rope grabs.

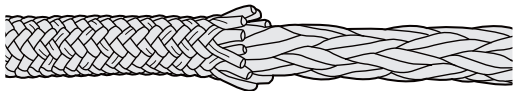

Double Braid (Page 93) - Double braided rope is, as the name implies, a braided core surrounded by a braided sheath. The inner and outer braids are generally designed to share the load equally with very low elongation. Double braid rope remains round under tension, imparts no rotational force when loaded and has a soft hand. These characteristics make it ideal for use as a load rope.

DIAMETER

As ropes get thicker, they get stronger. But there's a misconception that to be as safe as possible you should get the thickest rope available. In reality, your rigging is only as strong as your weakest component. The capstan, shackles, slings, blocks, and rope all must be considered. If you're using a 1,000 pound capstan hoist, most 1/2" Double Braids have an MBS high enough to safely handle the maximum load for the hoist; even with the safety factor, and any loss of strength due to knots, termination plates, or sewn eyes. While a 5/8" rope has a higher breaking strength, it would not matter since the hoist is only capable of lifting 1,000 pounds. Another thing to consider is the sheave diameter of the blocks being used. There are many options which can handle 1/2" synthetic rope, but few exist that are strong enough to justify 5/8" rope.

INSPECTION

Each time you use your rope, you should perform a visual inspection to ensure it's safe to use. Check for cuts, nicks, burns, excess fraying, flat or uneven spots, burns, harness, glossing, discoloration from sun exposure or chemicals, or inconsistencies in the rope. Refer to the manufacturers recommendations for complete inspection and usage instructions. Use a rope log, like the one available on www.gmesupply.com/knowledge-base to keep a complete record of inspections.

Another practice which is becoming more common is individual serial numbers for rope. This permanent label is useful to document when a rope goes into service, as well as track inspections.

**Have additional rope questions?
Give our Gear Experts® a call!**

FREE
DOWNLOAD

ROPE DIAMETERS

6 mm

7 mm

8 mm

5/16"

9 mm

3/8"

10 mm

11 mm

7/16"

12 mm

1/2"

13 mm

14 mm

15 mm

16 mm

5/8"

17 mm

18 mm

19 mm

3/4"

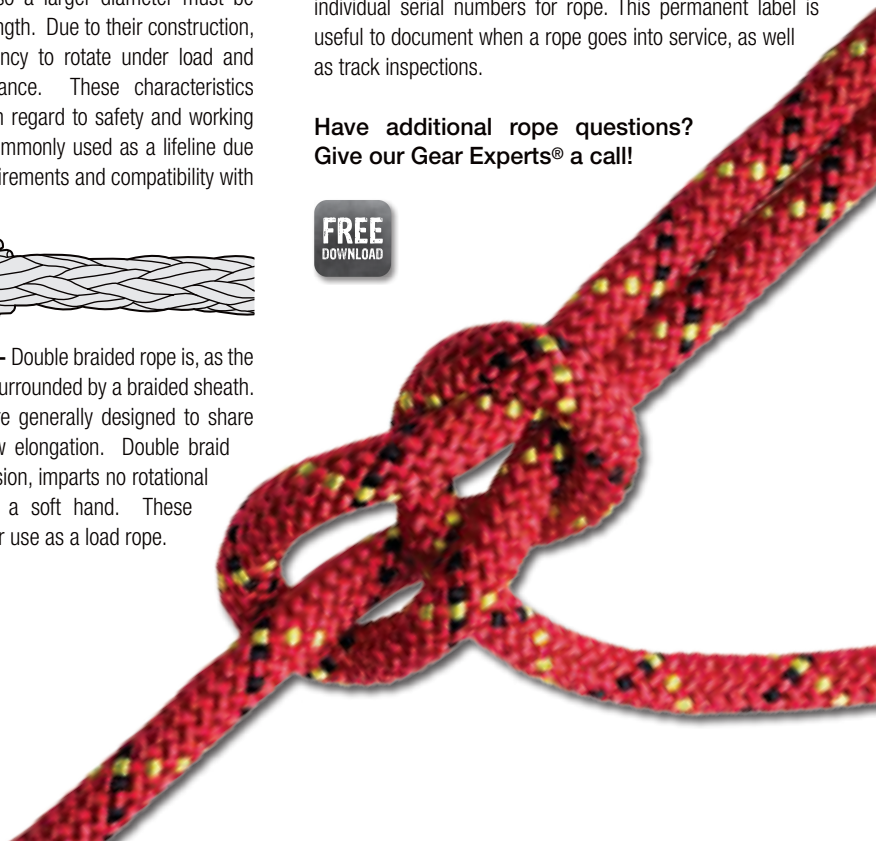

UNICORE TECHNOLOGY

Unicore Technology creates the ultimate bond between sheath and core. This bond ensures sheath slippage is nearly zero, even when the sheath is entirely cut circumferentially.

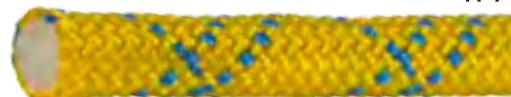
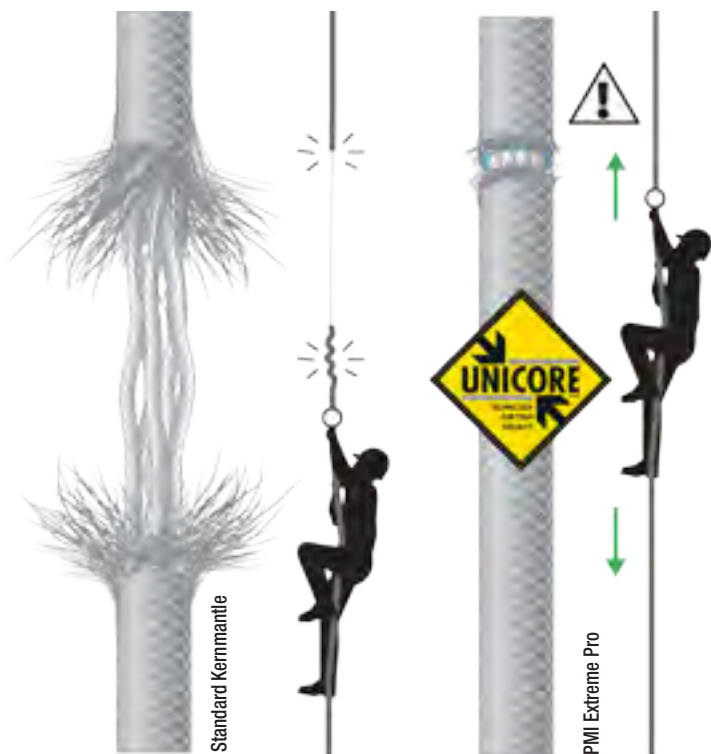

STERLING HTP STATIC

Sterling HTP static ropes have proven to be the most durable and best performing static ropes available. The benefits of using HTP include having a rope with better overall durability, higher strength, and extremely low stretch. With less stretch, the HTP is highly efficient rope for haul systems, rope bridges, and industrial rope access work. Sterling HTP ropes do not lose strength in wet conditions. Certified to NFPA 1983, 2012 edition. See the illustration above. Most stock ropes include sewn eye.

Key Features: 100% polyester static • Significantly lower elongation is perfect for any haul system

LENGTH	DIAMETER	STRENGTH	PART*	WHITE	COLOR†
300'	7/16" (11 mm)	MBS 6,856 lbs	P110_0092	\$289.25	\$315.85
300'	1/2" (13 mm)	MBS 9,081 lbs	P130_0092	\$326.85	\$367.40
300'	5/8" (16 mm)	MBS 12,993 lbs	P160_0092	\$436.50	\$471.95
600'	7/16" (11 mm)	MBS 6,856 lbs	P110_0183	\$569.55	\$621.90
600'	1/2" (13 mm)	MBS 9,081 lbs	P130_0183	\$643.50	\$723.45
600'	5/8" (16 mm)	MBS 12,993 lbs	P160_0183	\$859.40	\$929.20
1,200'	7/16" (11 mm)	MBS 6,856 lbs	P110_0366	\$1,139.10	\$1,286.00
1,200'	1/2" (13 mm)	MBS 9,081 lbs	P130_0366	\$1,273.75	\$1,433.40
1,200'	5/8" (16 mm)	MBS 12,993 lbs	P160_0366	\$1,744.00	\$1,909.00

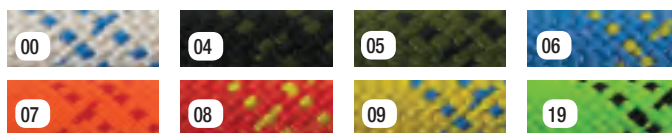

PELICAN STATIC MASTER

The first choice for strenuous use by arborists, fire and rescue professionals. Pelican's block creel static kermantle construction features a tough chemical-resistant polyester cover over a nylon core, providing maximum energy absorption. Steam setting helps to eliminate cover over core slippage. The rope is firm yet flexible enough to be tied or passed over a pulley sheave. These ropes are resistant to most chemicals and have excellent retention in extreme conditions. U.L. Certified to NFPA 1983-2006 edition standards.

LENGTH	DIAMETER	STRENGTH	PART*	WHITE	COLOR†
300'	7/16" (12 mm)	ABS 7,047 lbs	2WP-14_-03S	\$270.00	\$300.00
300'	1/2" (13.5 mm)	ABS 9,807 lbs	2WP-16_-03S	\$365.00	\$400.00
300'	5/8" (16 mm)	ABS 11,182 lbs	2WP-20_-03S	\$435.00	\$490.00
600'	7/16" (12 mm)	ABS 7,047 lbs	2WP-14_-06S	\$515.00	\$565.00
600'	1/2" (13.5 mm)	ABS 9,807 lbs	2WP-16_-06S	\$660.00	\$730.00
600'	5/8" (16 mm)	ABS 11,182 lbs	2WP-20_-06S	\$800.00	\$900.00
1,200'	7/16" (12 mm)	ABS 7,047 lbs	2WP-14_-12S	\$1,050.00	\$1,350.00
1,200'	1/2" (13.5 mm)	ABS 9,807 lbs	2WP-16_-12S	\$1,315.00	\$1,460.00
1,200'	5/8" (16 mm)	ABS 11,182 lbs	2WP-20_-12S	\$1,575.00	\$1,775.00

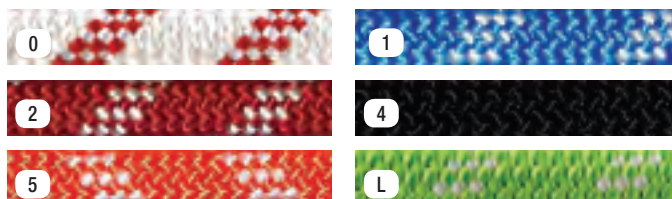

PMI EXTREME PRO

An incredible new PMI rope, Extreme Pro with Unicore technology is the ultimate 11 mm polyester kermantle rope. Unicore technology creates the ultimate bond between sheath and core that ensures sheath slippage is nearly zero, even when entirely cut circumferentially. If the sheath is cut, it will not slip down and bunch below the damaged area. See the illustration above. Most stock ropes include sewn eye.

Key Features: Unicore technology • Nearly zero sheath slippage • 100% Polyester Sheath • 100% Nylon 6.6 Core • Sheath cannot bunch

LENGTH	DIAMETER	COLOR	STRENGTH	PART	PRICE
300'	7/16" (11 mm)	GWO	MBS 8,452 lbs	PR110E1092UC	\$317.60
300'	7/16" (11 mm)	CWO	MBS 8,452 lbs	PR110E2092UC	\$317.60
600'	7/16" (11 mm)	GWO	MBS 8,452 lbs	PR110E1183UC	\$635.30
600'	7/16" (11 mm)	CWO	MBS 8,452 lbs	PR110E2183UC	\$635.30



*To complete the part number, replace the () with the corresponding color code.
 †Not all rope diameters are available in all colors.
 ‡Color patterns and tracer colors may vary slightly.
 For custom lengths, please call us at (800) 940-6762 or e-mail info@gmesupply.com.



STERLING SUPER STATIC

SuperStatic2 ropes are 100% nylon and excel in many applications, including rope access, technical rescue, rigging, and tactical operations. They are designed with a high denier and a tight, durable sheath to reduce stiffness; work well through gear, and provide smooth rappels. Sterling's Better Braid Technology matches their unique thermodynamic yarn balancing and twist in the core to proper twist and braid construction in the sheath to create a strong, resilient rope with a perfect balance of strength, proper elongation and exceptional handling. These ropes are easy to knot, will stay round, and have optimal elongation when loaded. Engineered and certified to the highest standards, Sterling's SuperStatic2 ropes have been field tested, used and proven by the top instructors, rescue personnel, and rope technicians worldwide.

Key Features: 100% nylon low stretch • 41/59 sheath/core ratio yields best durability and great handling

LENGTH	DIAMETER	STRENGTH	PART*	WHITE	COLOR†
300'	7/16" (11 mm)	MBS 6,744 lbs	SS110_0092	\$301.75	\$319.05
300'	1/2" (12.5 mm)	MBS 9,239 lbs	SS125_0092	\$337.70	\$392.50
300'	5/8" (16 mm)	MBS 11,240 lbs	SS155_0092	\$442.95	\$471.95
600'	7/16" (11 mm)	MBS 6,744 lbs	SS110_0183	\$594.20	\$628.10
600'	1/2" (12.5 mm)	MBS 9,239 lbs	SS125_0183	\$665.00	\$772.70
600'	5/8" (16 mm)	MBS 11,240 lbs	SS155_0183	\$872.05	\$929.20
1,200'	7/16" (11 mm)	MBS 6,744 lbs	SS110_0366	\$1,221.00	\$1,286.00
1,200'	1/2" (12.5 mm)	MBS 9,239 lbs	SS125_0366	\$1,360.00	\$1,579.00
1,200'	5/8" (16 mm)	MBS 11,240 lbs	SS155_0366	\$1,781.00	\$1,909.00

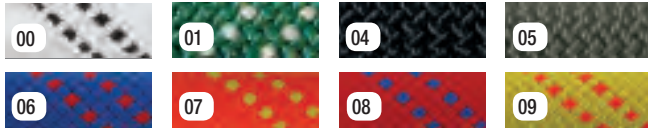

NEW ENGLAND KM III

An exceptional static rope for rappelling, caving, rescue, top roping, fixed rope applications, hauling, and life safety applications. The unique polyester sheath differentiates KM III from other static ropes. The polyester sheath is balanced with a nylon core to limit rotation, bouncing, and stretch. KM III is NFPA and CE approved, and all come with an NFPA certification tag and CE labels. Thirty-two bobbins provide the correct sheath for the unique demands of static rope and the optimum sheath/core ratio. This allows for an incredibly smooth sheath, higher tensile strengths, and superior handling characteristics. Most stock ropes include sewn eye.

Key Features: NFPA Certified • 32-carrier construction • Polyester over Nylon construction • Balanced, Torque Free Construction

LENGTH	DIAMETER	STRENGTH	PART*	WHITE	COLOR†
300'	7/16" (11 mm)	MBS 7,900 lbs	5YM_-14-00300	\$328.00	\$368.00
300'	1/2" (12.5 mm)	MBS 10,350 lbs	5YM_-16-00300	\$380.00	\$431.00
600'	7/16" (11 mm)	MBS 7,900 lbs	5YM_-14-00600	\$600.00	\$627.00
600'	1/2" (12.5 mm)	MBS 10,350 lbs	5YM_-16-00600	\$715.00	\$825.00

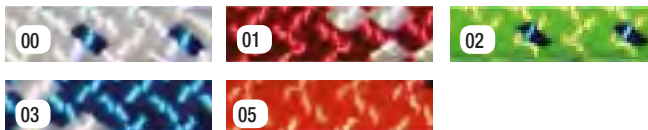

PMI CLASSIC PRO

PMI's Classic EZ-Bend 16-carrier construction combined with the toughest nylon on the market makes PMI ropes some of the toughest in the world. PMI Classic 16-carrier ropes will always beat 32, 40, and 48-carrier designs made with lesser quality nylons hands down in abrasion and real-world durability tests. Although all diameters of PMI Classic rope are 16-carrier sheath design, the denier (thickness) of each diameter's sheath is different. It is carefully designed to provide the maximum abrasion resistance, "grab" the core to minimize sheath slippage, and provide the desired hand for the intended applications.

Key Features: NFPA Certified • 16-carrier construction • CI1801 • Third party certified by UL (Underwriters Laboratories) • CE • Torsionally balanced, continuous filament nylon

LENGTH	DIAMETER	STRENGTH	PART*	WHITE	COLOR†
300'	7/16" (11 mm)	MBS 6,407 lbs	RR110_092E	\$283.20	\$340.00
300'	1/2" (12.5 mm)	MBS 9,442 lbs	RR125_092E	\$335.30	\$393.50
300'	5/8" (16 mm)	MBS 15,287 lbs	RR160_092E	\$419.10	\$488.10
600'	7/16" (11 mm)	MBS 6,407 lbs	RR110_183E	\$566.50	\$726.00
600'	1/2" (12.5 mm)	MBS 9,442 lbs	RR125_183E	\$670.60	\$787.10
600'	5/8" (16 mm)	MBS 15,287 lbs	RR160_183E	\$847.10	\$976.00
1,200'	7/16" (11 mm)	MBS 6,407 lbs	RR110_366E	\$1,137.80	\$1,360.00
1,200'	1/2" (12.5 mm)	MBS 9,442 lbs	RR125_366E	\$1,341.00	\$1,573.90
1,200'	5/8" (16 mm)	MBS 15,287 lbs	RR160_366E	\$1,694.20	\$1,952.00

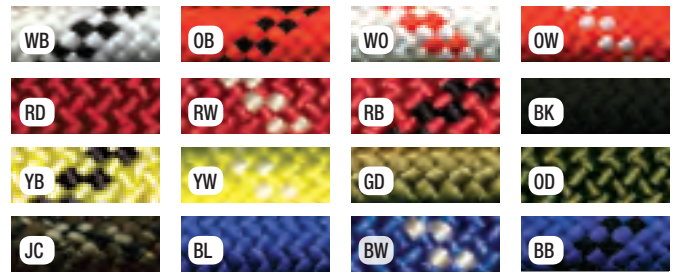

GME SUPPLY CONTROLLED DESCENT KIT

Kit includes 300' PMI 7/16" Extreme Pro Rope, GME Supply Yellow Waterproof Rope Bag, Petzl I'D Small Self-Braking Rope Descender, FallTech 3' Web Pass-Thru Anchor, and (2) 07400 4-7/8" x 3" steel carabiners.

91100-300 300' rope - \$649.99

91100-600 600' rope - \$939.99

PELICAN DYNEEMA TOW AND WINCH LINE

This high performance rope features superior strength, low weight, and specific gravity. Unaffected by oil and common chemicals, this high strength rope is easily spliced, exhibits low flex fatigue, near zero creep, excellent abrasion resistance with a low elongation-to-break ratio. Load-sharing and staggering failure built in can eliminate dangerous backlash. The fiber grades used in this rope are SK60, SK65, SK75 and SK78. Dyneema is, pound for pound, 10 times stronger than steel and 33% lighter than Nylon with over 3 times the strength of Polyester or Nylon. Additional protection is provided by urethane coating. Eyes are professionally hand-spliced along with polyester chafe guards. Break strength remains constant in wet or dry conditions, making this the perfect choice for heavy duty winch line, mooring and towing lines, offshore positioning ropes, yachting lines, and commercial fishing ropes. With a specific gravity of 0.98, this rope floats!

Key Features: Low flex fatigue • Near zero creep • High UV resistance • Floats on water • Eliminates backlash • 6% elongation at break • Excellent abrasion resistance • 3x stronger than polyester or nylon

LENGTH	DIAMETER	STRENGTH	PART	PRICE
600'	1/4" (6.5 mm)	ABS 8,400 lbs	7D-080-06S	\$785.00
600'	5/16" (8 mm)	ABS 13,200 lbs	7D-100-06S	\$1,100.00
600'	3/8" (10 mm)	ABS 19,000 lbs	7D-120-06S	\$1,450.00
1,200'	1/4" (6.5 mm)	ABS 8,400 lbs	7D-080-12S	\$1,570.00
1,200'	5/16" (8 mm)	ABS 13,200 lbs	7D-100-12S	\$2,200.00
1,200'	3/8" (10 mm)	ABS 19,000 lbs	7D-120-12S	\$3,140.00



STERLING TECH 11

Designed with rigors of tree work in mind, the Tech11 is an 11 mm rope constructed with an aramid sheath and nylon core. When used as a flip-line, it offers great abrasion resistance, incredible durability and security. This rope has been in development and field tested for several years. It has been exposed to some of the roughest conditions by rope access, fire rescue and arboriculture professions.

LENGTH	DIAMETER	STRENGTH	PART	PRICE
200'	7/16" (11 mm)	MBS 9,014 lbs	T11AN061	\$369.95
660'	7/16" (11 mm)	MBS 9,014 lbs	T11AN200	\$1,211.30



STERLING TECH 125

The most durable, strong and heat resistant rope Sterling makes. The Tech 125 is perfect for roof-rescue and other high heat and abrasion intensive activities. With a heat and cut resistant Technora sheath and a balanced nylon core, the Tech 125 offers extreme durability in a general-use size rope.

LENGTH	DIAMETER	STRENGTH	PART	PRICE
150'	1/2" (12.5 mm)	MBS 10,183 lbs	T12AN046	\$391.45
200'	1/2" (12.5 mm)	MBS 10,183 lbs	T12AN061	\$509.00
300'	1/2" (12.5 mm)	MBS 10,183 lbs	T12AN092	\$782.90
660'	1/2" (12.5 mm)	MBS 10,183 lbs	T12AN200	\$1,700.00



*To complete the part number, replace the () with the corresponding color code.
 †Not all rope diameters are available in all colors.
 ‡Color patterns and tracer colors may vary slightly.
 For custom lengths, please call us at (800) 940-6762 or e-mail info@gmesupply.com.

STERLING ACCESSORY CORD

These cords have a very durable sheath and high MBS which makes them great for prusik cords, cordelettes, ice threads, lightweight low-stretch fixing and hauling "tag" lines. Patterns and colors vary by size. To complete the part number, replace the () with the corresponding color code.

LENGTH	DIAMETER	STRENGTH	PART	PRICE
50 m	6 mm	MBS 1,978 lbs	AN60__0050	\$64.95
100 m	6 mm	MBS 1,978 lbs	AN60__0100	\$128.00
200 m	6 mm	MBS 1,978 lbs	AN60__0200	\$253.30
50 m	7 mm	MBS 2,788 lbs	AN70__0050	\$79.90
100 m	7 mm	MBS 2,788 lbs	AN70__0100	\$158.30
200 m	7 mm	MBS 2,788 lbs	AN70__0200	\$313.20
50 m	8 mm	MBS 3,934 lbs	AN80__0050	\$99.50
100 m	8 mm	MBS 3,934 lbs	AN80__0100	\$197.00
200 m	8 mm	MBS 3,934 lbs	AN80__0200	\$389.90

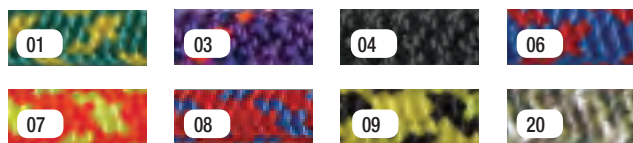

STERLING 8 MM PRUSIK CORD

LENGTH	DIAMETER	COLOR	STRENGTH	PART	PRICE
16"	8 mm	Orange	MBS 4,496 lbs	SC080320716	\$12.00
16"	8 mm	Red	MBS 4,496 lbs	SC080320816	\$12.00
22"	8 mm	Blue	MBS 4,496 lbs	SC080320622	\$12.25



STERLING 6 MM PRUSIK CORD

LENGTH	DIAMETER	COLOR	STRENGTH	PART	PRICE
44"	6 mm	Yellow	MBS 2,810 lbs	SC060NYTR044	\$11.50
9.5"	6 mm	Orange	MBS 2,810 lbs	SC060NYRTL09	\$9.25
9.5"	6 mm	Blue	MBS 2,810 lbs	SC060NYRTD09	\$9.25



16 CARRIER ARBORIST LINE

Made from polyester with nylon core in a 16 carrier construction, this rope has high strength, durability and performance. It is highly resistant to abrasion, easy to grip, and has great knot tying capabilities.

LENGTH	DIAMETER	STRENGTH	PART	PRICE
150'	1/2" (12.5 mm)	MBS 6,000 lbs	16DB160150	\$167.00
300'	1/2" (12.5 mm)	MBS 6,000 lbs	16DB160300	\$334.00
600'	1/2" (12.5 mm)	MBS 6,000 lbs	16DB160600	\$668.00





DBI SALA WATERPROOF LARGE ROPE BAG

33" height, 9" width, (3) carrying methods: carry handle, shoulder sling, adjustable backpack style straps; drawstring throat cord lock closure, clear plastic external pocket, internal pocket, stiffened rim, heavy-duty PVC construction, top and bottom haul loops, holds 328' of 1/2" rope, orange.

8700223 - \$118.99
8700224 Extra large, 29" height, 13" width, red - \$135.99



PETZL ROPE BUCKET

Bag remains upright and has an exterior folding lid system that allows easy access to the contents of the bag, external zippered pocket for personal effects, transparent external window, (2) large, comfortable carrying handles; adjustable strap for carrying bandolier style.

S41YA 035 35 liters - \$64.95
S41YA 025 25 liters - \$59.95



STERLING ROPE BAG

Sterling's rope bags are available in three sizes and feature padded backpack straps for easy hauling, a clear front pocket to store a rope log, and a rope cinch closure; large red bag, holds up to 400' of 1/2" rope.

MDBAGROPEL08 Large, 25" height, 11" diameter, red - \$46.85
MDBAGROPES09 Small, 19" height, 10" diameter, yellow - \$35.85
MDBAGROPEM07 Medium, 22" height, 17" width - \$40.50



PMI DELUXE LARGE ROPE PACK

Roomy rope compartment, double sewn seams, 1000 denier heavy coated Cordura, drawstring closure, padded backpack straps, 5/8" grommet on bottom of bag, 2" webbing carrying handles, (2) large outside pockets with snap buckle closure, internal clip-in loop at bottom of bag.

RB44004 Blue - \$112.50
RB44006 Red - \$112.50
RB44002 Orange - \$112.50



PMI LARGE ROPE PACK

25" height, 10.5" width, double sewn seams, 1000 denier heavy coated Cordura, drawstring closure, 1" tubular handles with rope insert, 5/8" grommet on the side of the bag, outside pocket, padded backpack straps, internal clip-in loop at bottom of bag, red. Also available in blue, black, and orange.

RB44021 L - \$55.25
RB44024 XL, 23" height, 16" width - \$59.50
RB44056 XXL, 28.5" height, 17" width - \$61.50



CUSTOMER CHOICE VIDEO KITS SAVE CASH

GME SUPPLY PREMIUM ROPE BAG

Easy fold lid to cover zipper from exposure to the elements, comfortable backpack straps, easy access side carry handle, straps that overlap at the top to allow easy hardware connection for hoisting, large transparent front pocket, gusseted bottom for moisture resistance, sewn-in web reinforcement from back to front, exclusive GME Supply "Climb Higher" logo.

5600RB Orange - \$87.99
5605RB Black - \$87.99
5610RB Yellow - \$87.99
ROPEBAGKIT All 3 bags - \$253.97

HOW MUCH BAG DO YOU NEED?

BAG DESCRIPTION	10 MM OR 3/8"	11 MM OR 7/16"	12.5 MM OR 1/2"
Sterling Small Rope Bag	97 m or 319'	93 m or 305'	61 m or 200'
Sterling Large Rope Bag	212 m or 696'	159 m or 522'	121 m or 400'
Petzl S41 035 Rope Bucket	400 m or 3,312'	310 m or 1,017'	260 m or 853'
Petzl S41 025 Rope Bucket	280 m or 918'	220 m or 721'	185 m or 606'
DBI Sala Large Rope Bag	250 m or 820'	200 m or 656'	100 m or 328'
DBI Sala XL Rope Bag	285 m or 935'	230 m or 754'	200 m or 656'
GME Supply Premium Rope Bag	250 m or 820'	200 m or 656'	100 m or 328'
PMI Standard Rope Bag	120 m or 393'	100 m or 328'	75 m or 246'
PMI Large Rope Bag	160 m or 524'	120 m or 393'	92 m or 301'
PMI XL Rope Bag	250 m or 820'	200 m or 656'	170 m or 557'
PMI XXL Rope Bag	285 m or 935'	230 m or 754'	200 m or 656'
PMI Deluxe Large Rope Bag	160 m or 524'	120 m or 393'	92 m or 301'



WESTFALL PRO 3-STRAND POLY-DACRON COMBINATION ROPE

High tensile polyester fiber wrapped cover over polyolefin core yarns, good abrasion resistance and strength.

LENGTH	DIAMETER	MBS STRENGTH	PART	PRICE
300'	5/8"	7,400 lbs	5800-300	\$210.00
600'	5/8"	7,400 lbs	5800-600	\$420.00
1,200'	5/8"	7,400 lbs	5800-1200	\$550.00



WESTFALL PRO 3-STRAND COMPOSITE VERTICAL LIFELINE WITH SNAPHOOK ENDS

Constructed of a 5/8" 3-strand polyester rope, ANSI compliant double locking safety snap hook, lightweight, abrasion resistant, low stretch, energy absorbent, 420 lbs capacity, ANSI compliant.

5810-300 300' - \$259.99

5810-600 600' - \$479.99

GUARDIAN 50' POLY STEEL LIFELINE WITH SHOCK PACK

5/8" poly steel rope is ideal for high-moisture environments; resists cuts and abrasion; available with a shock absorber, positioning device, 18 inch extension lanyard, and 2 double-locking snaphooks; ANSI compliant.

01320 50' - \$154.99



KITS SAVE CASH

GME SUPPLY BASIC LIFELINE KIT

Kit includes 300' French Creek Lifeline, WestFall Pro Rope Grab Assembly, GME Supply Black Waterproof Rope Bag, Guardian Premium Cross Arm Strap.

91000-300 - \$424.99



KITS SAVE CASH

GME SUPPLY PREMIUM LIFELINE KIT

Kit includes 300' PMI 7/16" Extreme Pro Rope, Petzl ASAP Mobile Rope Grab, Petzl Absorbica Energy Absorber, GME Supply Yellow Waterproof Rope Bag, Guardian Premium Cross Arm Strap, and (2) WestFall Pro 07405 4-1/2" x 2-3/4" steel carabiners.

91050-300 - \$774.99

**DBI SALA
LAD-SAF ROPE GRAB**

Mobile design automatically follows user for hands-free operation, detachable design can be attached or removed anywhere along lifeline, inertia and cam-locking systems for safety and "panic-grab" prevention, for use on 5/8" polyester/polypropylene rope lifeline, use with 3' shock absorbing lanyard.

5000335 - \$147.99
5002045 With 1242007
EZ-Stop lanyard - \$229.99



**ELK RIVER ROPE
GRAB WITH
ATTACHED ZORBER**

5/8" rope grab with attached Zorber web lanyard, moves up and down the length of vertical rope lifelines providing continuous fall protection.

19273 - \$99.99

**WESTFALL PRO TRAILING
ROPE GRAB WITH LANYARD**

Designed for 5/8" 3-strand rope, rope grab with 2" ring, anti-panic lock for added safety, anti-inversion plate for proper installation on rope, includes Guardian 01214 3' shock absorbing lanyard, ANSI compliant.

60601 - \$84.95
6050 Rope grab only - \$59.99



**PROTECTA COBRA
ROPE GRAB**

Constructed of high impact resistant steel, 1.75 lbs total weight, operates in automatic or manual mode, accommodates 5/8" rope, can be removed and reattached to rope at any point during traverse, designed for use with nylon or polyester rope.

AC202D - \$97.99



**WESTFALL PRO DELUXE
ROPE GRAB WITH LANYARD**

5/8" deluxe self-tracking/park rope grab, 2' shock absorbing lanyard, self-tracking design provides ease of vertical movement, hinged body allows simple placement at any point along rope, locks onto the rope lifeline at the onset of a fall event. Compared to MSA rope grab with lanyard.

60612 - \$214.99



**FALLTECH ROPE GRAB
WITH LANYARD**

5/8" hinged self-tracking rope grab, 3' shock absorbing lanyard, self-tracking design provides ease of vertical movement, hinged body allows simple placement at any point along rope, locks onto the rope lifeline at the onset of a fall event.

8358 - \$98.99



**GUARDIAN ROPE
GRAB WITH LANYARD**

Removable rope grab; easy to install; fits 5/8" or 1/2" thick safety ropes; locks automatically when a fall occurs; includes attached 3' shock absorbing lanyard; made of galvanized steel; minimum breaking strength 5,000 lbs.

01503 - \$97.99



PETZL ABSORBICA

Tear-webbing energy absorber, for use in combination with a JANE lanyard to make an energy-absorbing lanyard; maximum length of two meters; ends equipped with string to hold the connector in position and protect the sling from abrasion; compact and lightweight; 551 lbs weight capacity. If using the ASAP or ASAP Lock in two-person rescue technique, an Absorbica must be used as an energy absorber. The ASAP Sorber lacks sufficient energy absorption to safely arrest the potential energy during a two-person rescue.

L57 - \$58.95



PETZL ASAP MOBILE FALL ARRESTER

Arrests falls, slides, and uncontrolled descents; works on vertical or angled rope; locks on the rope even if grabbed during the fall; moves up or down the rope without any manual manipulation of the device; easy to install and remove at any point on the rope; may be combined with an ASAP Sorber or Absorbica energy absorbing lanyard to work at a distance from the rope; comes with an OK Triact-Lock automatic locking carabiner; for use on Kernmantle ropes between 10 mm - 12 mm; weight capacities: 220 lbs without energy absorber, 308 lbs with ASAP Sorber, 551 lbs with Absorbica.

B71AAA - \$249.95



PETZL ASAP'SORBER LANYARD WITH ENERGY ABSORBER

Connects the ASAP or ASAP Lock mobile fall arrester to the harness, allows the user to distance himself from the rope in order to declutter the work area and protect the rope from sharp tools and molten metal splash, absorbs the energy of a fall by the tearing of specific stitching, available in (2) lengths for a choice of the best balance between distance from the rope and reducing the fall length, 308 lbs weight capacity.

L71AA 20 20 cm - \$40.95

L71 AA 40 40 cm - \$50.95



PETZL ASAP LOCK MOBILE FALL ARRESTER

Integrated locking function allows the user to immobilize the device to reduce the length of a fall. In case of a strong wind, this function also prevents the rope from being blown upward. Arrests falls, slides, and uncontrolled descents; works on vertical or angled rope, locks on the rope even if grabbed during the fall, moves up or down the rope without any manual manipulation, easy to install and remove at any point on the rope, connection arm makes the system loss-resistant when passing intermediate anchors, may be combined with an ASAP Sorber or Absorbica energy absorbing lanyard to work at a distance from the rope, for use on Kernmantle ropes between 10 mm - 13 mm; weight capacities: 308 lbs with ASAP Sorber, 551 lbs with Absorbica.

B71ALU - \$279.95



KONG BACK-UP MOBILE FALL ARRESTER

Supports fall factor 2 falls in a semi-dynamic way, without damage to the safety rope; works on vertical or angled rope; moves up or down along the rope without manual intervention; easy to install and remove at any point on the rope; for rope access applications unit can be used with tug cord; 10.0 mm - 12.0 mm semi-static ropes (EN 1891 type A) certified with the device; one person weight capacity 220 lbs.

802 - \$149.99



DBI SALA ROPE-SAFE MOBILE/STATIC ROPE GRAB WITH ATTACHED EZ-STOP

Easy to use automatic to manual operation switch; integrated tow cord; built-in swivel; swivel cover; built-in anti-panic grip; triple action aluminum carabiner; (2) person rescue load rated up to 440 lbs; for use with 27/64 in. to 1/2 in. (10.5 mm - 13.0 mm) Kernmantle rope; 1' integral energy absorbing lanyard.

8700620 1' lanyard - \$392.99

8700643 2' lanyard - \$392.99

8700621 3' lanyard - \$392.99



MIO ROPE GRAB

Stainless steel self-trailing rope grab, removable dual action pin for easy placement, grips automatically in the event of a fall and dissipates the energy of the fall by slipping along the rope, comes with lanyard and ANSI snaphook, for use with 1/2" Kernmantle rope.

RG1200 1/2" rope - \$160.00

RG5834 5/8" rope - \$160.00

RG716 7/16" rope - \$160.00





PETZL CROLL CHEST ROPE CLAMP

Compact, lightweight chest rope clamp; used with the ASCENSION handled rope clamp for ascending a rope, toothed cam with self-cleaning slot optimizes performance under any conditions; stainless steel cam has better resistance to corrosion, catch is opened by pinching for easy manipulation; reinforced rope channel with stainless steel for greater durability for use with Kernmantle ropes 8 mm - 11 mm in diameter; 308 lbs weight capacity.

B16BAA - \$69.95



NEW

WESTFALL PRO CHEST ASCENDER

Compact and lightweight; cam is spring-loaded and fitted with a catch mechanism; easy for one-handed operation; increased grip at low load, even on wet, greasy, oily ropes; cam made from stainless steel for greater durability for use with Kernmantle ropes 9 mm - 13 mm in diameter.

60400 - \$41.99



PETZL ASCENSION HANDHELD ROPE CLAMP

Designed for ascending and occasionally for hauling (progress capture); wide, ergonomic molded handle allows a comfortable yet powerful grip; lower holes for connecting a SPELEGYCA lanyard and installing a footape foot loop with a quick link, toothed cam with self-cleaning slot optimizes performance under any conditions, upper hole through which a carabiner attaches the device to the rope, for single Kernmantle ropes between 8 mm - 13 mm in diameter; 308 lbs weight capacity.

B17ALA Left handed - \$84.95

B17ALN Left handed, black - \$86.95

B17ARA Right handed - \$84.95

B17ARN Right handed, black - \$86.95



KONG DUCK ROPE CLAMP

Duck, the innovative emergency rope clamp. Conceived for single Kernmantle ropes with a diameter between 8 mm - 13 mm, Duck is the first and only belay device that works also on plane and tubular slings from 10 mm - 15 mm width (even if these are not certified for progression). Due to the small dimensions, it can be easily inserted even with one only hand. The big hole allows the rotation of sleeve connectors. Use the Duck as an emergency rope clamp during self belay, retrievals, progression maneuvers and regulating daisy chains. 220 lbs weight capacity.

888 - \$91.99



PETZL FOOTAPE ADJUSTABLE FOOT SLING

Attaches to the ASCENSION handheld ascender for rope ascents, underfoot strap is abrasion-resistant and is slightly rigid to make it easier to step into, adjustable elastic keeps the foot in the foot loop with any type of shoe, mini DoubleBack buckle easily and quickly adjusts length of foot loop.

C47A - \$34.95



KONG LIFT RIGHT HANDED ASCENDER

Excellent ability to block out particularly on muddy and icy ropes thanks to the holes on the cam and on the side plate. The new material and a special chemical and thermal process give to the cam a much higher surface hardness. The result is a great wear resistance and a reduction of the fragility that usually penalizes steels by quenching to low temperatures. New opening lever, ergonomic, easy to handle and protected from shocks and from the risk of accidental opening. For Kernmantle ropes 8 mm - 13 mm, 200 lbs weight capacity.

896R04D00KK Right handed - \$71.95

896B04S00KK Left handed - \$71.95



PETZL RESCUCENDER CAM-LOADED ROPE CLAMP

Simple to use and ergonomic, the rescucender is an openable cam-loaded rope clamp designed for use in haul systems as a tractor or progress capture device; for single Kernmantle ropes between 9 mm - 13 mm in diameter; 308 lbs weight capacity.

B50A - \$84.95



VIDEO

PETZL SMALL I'D DESCENDER

Large handle is rotated in various orientations to control whether the unit is in descent, stopped, or complete lock-off. For rope between 10 mm - 11.5 mm in diameter, ANSI Z359.4 compliant.

D200S0 - \$269.95



CUSTOMER CHOICE

VIDEO

PETZL LARGE I'D DESCENDER

Large handle is rotated in various orientations to control whether the unit is in descent, stopped, or complete lock-off. For rope between 11.5 mm - 13 mm in diameter, ANSI Z359.4 compliant.

D200L0 - \$269.95



NEW

VIDEO

WESTFALL PRO D5 WORK RESCUE DESCENDER

Unique innovative cam action for precise control, 500 lbs working load limit suitable for a two-man rescue, panic brake, 22 kN MBS, compatible with 1/2" rope diameter, ANSI Z359.4 compliant.

60505 - \$249.99



NEW

VIDEO

WESTFALL PRO D4 WORK RESCUE DESCENDER

Unique innovative cam action for precise control, 500 lbs working load limit suitable for a two-man rescue, panic brake, 22 kN MBS, compatible with 7/16" rope diameter, ANSI Z359.4 compliant.

60504 - \$249.99



DBI SALA FISK DESCENDER

Descent control system designed for durability, thermal capacity and smooth flow, allows the operator to tie off and position themselves at a specific work level.

2103189 - \$257.99



DBI SALA NOWORRIES DESCENDER

Incorporates the functionality of a stop descender, chest ascender, and belay device in one compact unit, allows user to hard lock, for rope 10.5 mm - 12 mm in diameter, ANSI Z359.4 compliant.

8700387 - \$254.99



DBI SALA NOWORRIES DESCENDER

Incorporates the functionality of a stop descender, chest ascender, and belay device in one compact unit, allows user to hard lock, for rope 12.5 mm - 13.5 mm in diameter, ANSI Z359.4 compliant.

8700388 - \$319.99



ROCK EXOTICA UNICENDER

This revolutionary device combines ascending and descending in one piece of gear, works with both single and double rope technique, with seamless transition between ascending and descending, for ropes 11 mm - 13 mm.

RG50 - \$309.00





MBS
80 kN

VIDEO

**ROCK EXOTICA
OMNI-BLOCK SWIVEL PULLEY**

The Omni 2.6" brings heavy duty rigging to the Omni family with an MBS of 80 kN and WLL of 20 kN. In addition to the large 2.6" sheave, the P55 features a prusik minding side plate, and push-button access to install rope. For material handling see page 93.

P55 - \$155.00



MBS
36 kN

VIDEO

**ROCK EXOTICA
OMNI-BLOCK
1.5 SWIVEL
PULLEY**

Can replace a conventional pulley, carabiner, and swivel and is lighter, less expensive and saves valuable vertical space, allows installing/removing the rope while the pulley is still anchored, sheave diameter 1.5".

P51 - \$82.00

P51-B Black - \$84.00



MBS
36 kN

VIDEO

**ROCK EXOTICA
OMNI-BLOCK
2.0 SWIVEL
PULLEY**

Can replace a conventional pulley, carabiner, and swivel and is lighter, less expensive and saves valuable vertical space, allows installing/removing the rope while the pulley is still anchored, sheave diameter 2".

P53 - \$109.00

P53-B Black - \$111.00



MBS
44 kN

**ROCK EXOTICA
PRUSIK
MINDING
PULLEY**

Milled from solid 7075 aluminum so material can be taken away where it's not needed and left where it is, axle is machined as part of the side plate, compact, stronger and lighter weight than conventional stamped pulleys; sheave diameter 2".

P1 - \$60.00

P1-B Black - \$61.00



MBS
23 kN

**ROCK EXOTICA
OMNI-BLOCK
1.1 SWIVEL
PULLEY**

Combines pulley with a swivel; replaces conventional pulley, carabiner and swivel; max rope diameter 13 mm, 23 kN MBS; sheave diameter 1.1".

P54 - \$76.50

FOR ASME B30 RIGGING BLOCKS
SEE PAGE 93



MBS
20 kN

**PETZL MOBILE
PULLEY**

Lightweight, compact pulley, designed for hauling systems and deviations, sheave mounted on self-lubricating bushings for efficiency.

P03A - \$24.95



**PETZL ROLLCLIP
PULLEY CARABINER**

Triact-Locking minimizes friction on the work rope and install redirects; for ropes 7 mm - 13 mm in diameter and maximum working load of 4 kN.

P74-TL - \$47.95



MBS
20 kN

**PETZL ROLLCLIP Z
PULLEY CARABINER**

Pulley-carabiner with gate opening on the non-pulley side to facilitate installation on anchors and devices; for ropes 7 mm - 13 mm in diameter, and maximum working load of 4 kN.

P75-TL Triact-lock - \$47.95

P75-SL Screw-lock - \$42.95



MBS
22 kN

**BLUEWATER ROPES
MICRO PULLEY**

Lightweight design features a steel axle, anodized aluminum frame and aluminum sheave; for ropes 8 mm - 13 mm in diameter.

610116 Black - \$12.95

610117 Orange - \$12.95



MBS
22 kN

SMC CRX PULLEY

Smooth running 1.25" nylon sheave runs on a stainless steel rivet axle and the color-contrasting aluminum side plates rotate for easy rope insertion and removal, compact size, for ropes up to 13 mm.

157303 - \$15.99



2.6" OMNI RIGGING-BLOCK

MHP55

- 4,500 lbf WLL, based on 4:1 design factor
- Install and remove rope while staying connected to the anchor
- Sideplate locks with two-stage, double-catch safety mechanism
- Integrated swivel allows pulley to orient while reducing gain
- Connect, install and remove rope with one hand



ASME
B30
COMPLIANT

PROUDLY ENGINEERED &
MANUFACTURED IN THE USA
FROM PRECISION MACHINED
PARTS & COMPONENTS





MBS
36 kN

CUSTOMER CHOICE

VIDEO

ROCK EXOTICA OMNI-BLOCK 1.5 DOUBLE

Can replace a conventional pulley, carabiner, and swivel and is lighter, less expensive and saves valuable vertical space, allows installing/removing the rope while the pulley is still anchored, sheave diameter 1.5".

P51D - \$126.00

P51D-B Black - \$128.00



MBS
36 kN

ROCK EXOTICA AZTEK PULLEY SET

Engineered from a solid block of aluminum to maintain strength; come together in either a blue/orange set or black set with laser engraved 'A' and 'B' markings; this coding is used to help set them up in the 4:1 configuration when used with Sterling's 6 mm ratchets; can accept up to an 8 mm rope.

P41SET - \$232.05

P41SET-B Black - \$234.05



MBS
40 kN

VIDEO

ROCK EXOTICA OMNI-BLOCK 2.0 DOUBLE SWIVEL PULLEY

Install and remove rope while still connected to the anchor; side plate locks with two-stage, double-catch safety mechanism; integrated swivel allows pulley to orient while reducing gain; connect, install and remove rope with one hand; CNC machined for optimal weight and strength; sheave diameter 2".

P53D - \$165.00

P53-B Black - \$167.00



MBS
36 kN

ROCK EXOTICA MACHINED RESCUE 1.5 DOUBLE PULLEY

Machined—not stamped parts, create a stronger pulley, increasing its strength-to-weight ratio; axle is integrated into side plates, adding additional strength and rigidity to the pulley; machined side plates allow for a more compact design while maintaining the same rope capacity of other pulleys; sheave diameter 1.5".

P22D - \$101.00



MBS
30 kN

ROCK EXOTICA MACHINED MINI 1.1 DOUBLE PULLEY

Recessed axle screw sits flush to pulley side plates; Machined—not stamped parts, create a stronger pulley; axle is integrated into side plates, adding additional strength and rigidity to the pulley; machined side plates allow for a more compact design; sheave diameter 1.1".

P21D - \$87.50

P21D-B Black - \$88.50



MBS
44 kN

ROCK EXOTICA PMP 2.0 DOUBLE PRUSIK MINDING PULLEY

Milled from solid 7075 aluminum; sheave diameter 2.0"; max rope 13 mm.

P1D - \$113.00



MBS
36 kN

PETZL TWIN PULLEY

High strength, high efficiency double Prusik pulley, special side plates for use with a Prusik friction hitch in progress capture systems.

P65A - \$119.95



MBS
23 kN

PETZL GEMINI PULLEY

Special side plates designed for use with a Prusik friction hitch in progress capture systems. Parallel mounted sheaves and auxiliary attachment point.

P66A - \$89.95



MBS
22 kN

PETZL JAG

Double pulley designed for use with the JAG TRAXION double progress capture pulley to make a 4:1 haul system; sheaves mounted on sealed ball bearings.

P45 - \$89.95



MBS
34 kN

SMC ADV TECH MATE DOUBLE PULLEY

Made from high quality aluminum; anodized to help prevent corrosion; supports rope diameters from 7 mm up to 12.5 mm.

SM154801N - \$89.95



MBS
22 kN



PETZL PRO TRAXION

Integrated progress capture device can be used as a pulley or rope clamp, lockable moving side plate for easy rope installation; for ropes from 8 mm - 13 mm in diameter.

P51A - \$144.95



MBS
15 kN



PETZL MICRO TRAXION

Ultra-light, ultra-compact progress-capture pulley that is exceptionally efficient (91%) thanks to its sealed ball bearings; can be used as a simple pulley.

P53 - \$119.95



MBS
40 kN

PETZL KOOTENAY KNOT-PASSING PULLEY

Voluminous rope channel allows the passage of joining knots, large diameter sheave mounted on sealed ball bearings for excellent efficiency, locking pins on the sheave allow use of the pulley as an anchor.

P67 - \$193.95



MBS
16 kN

PETZL JAG TRAXION

Double progress capture pulley designed for use with the JAG double pulley to make a 4:1 haul system. Sheaves mounted on sealed ball bearings for excellent efficiency.

P54 - \$134.95



MBS
22 kN

PETZL PRO

High-efficiency loss-proof pulley; openable even when attached to the anchor, designed for maximum simplicity when setting up hauling or load deviation systems.

P46 - \$79.95

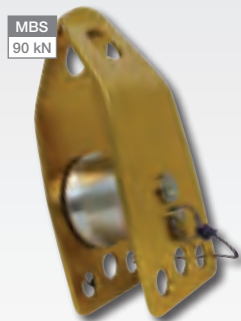

MBS
90 kN

DBI SALA KNOT PASSING PULLEY

Can be used as an edge roller for rope protection, a rigging point, or an anchor; for ropes 11 mm - 80 mm.

8700039 - \$210.99



MBS
39 kN



ROCK EXOTICA KOOTENAY ULTRA

Lightweight and compact and features a single locking screw; (2) holes to separate your tag/hoist lines and to prevent spinning.

P3 - \$202.00

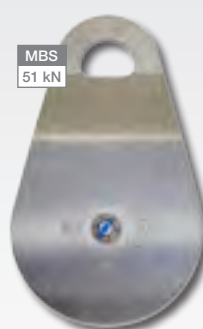

MBS
51 kN

SMC 4" STAINLESS STEEL PULLEY

High efficiency sealed ball bearings, matched double-bend side plates help eliminate compression under load.

SM152500 - \$126.05



MBS
34 kN

SMC ADVANCE TECH HX DOUBLE PULLEY

Integrated cam for progress capture without the need of Prusiks, high efficiency sealed ball bearing, one-handed operation.

SM154900 - \$141.80



MBS
28 kN

ROCK EXOTICA HYDRA TRIPLE ATTACHMENT

Can be used as a pulley, rigging plate, and a swivel; add multiple connections that will still rotate when needed.

P4 - \$89.95



YATES BIG WALL LADDER

The Yates Big Wall Ladder offers the simplicity of traditional 1" Etriers with the comfort of 2" Wall Etriers. Yates sewn products are Berry Amendment compliant. The Yates line of products have been designed and developed over the years with input and collaboration from many professional users in the field; (6) steps; measures 70".

532 - \$53.00

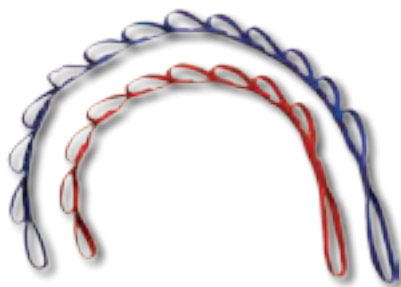

PMI GEAR DAISY

Single length of webbing, hand loop at one end, made from 1" tubular nylon webbing, helps organize your gear, each loop holds 2 kN (450 lbf) because of the "double back" construction.

SG50135 3' (9) Gear loops 24" - \$21.00

SG51041 4' (13) Gear loops 24" - \$25.00

STERLING 1" TYPE 9800 FLAT WEBBING

Type 9800 webbing is a flat, woven nylon webbing that is abrasion resistant and offers a high tensile strength. The increased strength is often preferred in harsh or abrasive environments for anchor building, hauling or making harnesses. Because Type 9800 is woven solid opposed to a tubular webbing, it can be more difficult to handle.

LENGTH	WIDTH	STRENGTH	PART	PRICE
150'	1"	MBS 9,800 lbs	WB2549809046	\$100.45



STERLING 11/16" WEBBING SPOOL

Provides great strength and low weight which makes it versatile for slings and daisy chains.

LENGTH	WIDTH	STRENGTH	PART*	PRICE
300'	11/16"	MBS 3,000 lbs	WB174NY__091	\$122.75



STERLING MIL-SPEC WEBBING

The standard in 1" webbing, Mil-Spec tubular webbing is favored by climbers and rescue specialists for slings and anchor systems as it offers exceptional abrasion resistance. As its name implies, Mil-Spec is also the standard webbing for military applications.

LENGTH	WIDTH	STRAIGHT PULL	SEWN LOOP	PART*	PRICE
300'	1"	MBS 4,000 lbs	MBS 6,129 lbs	WB254MS__091	\$114.05

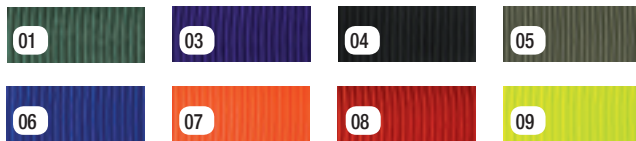

ROCK EXOTICA TRIRIG

Lightest high performance (3) hole plate; milled from oversize material so that all surfaces are machined, even the faces.

RP1 - \$27.00



ROCK EXOTICA PENTAPLATE

Made of strong aerospace aluminum alloy, (5) hole plate; thin design has the benefit of fitting carabiners and links better with less possibility of binding.

RP2 - \$47.00



PETZL PAW

19 mm holes allow the locking sleeves of most carabiners to pass through.

P63 M - \$54.95

P63 S (3) anchor point holes - \$29.95



ROCK EXOTICA BOLT

Uses a quick detachable stainless steel rod, or 'bolt', allowing you to connect your gear directly to the five connection points without using carabiners.

RP5 - \$114.00





PMI ROPE ID MARKERS BOOK

Write, type, or stamp information on white area. The clear self-lamination portion wraps around to protect writing. Made of vinyl. Includes 6 tags per sheet, 10 sheets per book.

RC48001 - \$34.99



PMI ROPE ID KIT

Protect rope ends and provide important information such as when a rope is put into service, ID, etc. Write your own information on the ID tags and slip between shrink tube and rope. Marks any rope (RC48007 3/8" kit only). Kit includes 6 tags and 12 inches of 3/4" shrink tube.

RC48030 - \$6.99



PMI ID SHRINK TUBE

Heat shrinkable tubing for marking and finishing off rope ends. Slip over end of rope and apply hot air or infrared heat source of 275°F. Clear tubing will shrink tightly around rope and marker. Sold in whole foot increments.

RC48007 3/8" - \$0.42/foot

RC48008 3/4" - \$0.65/foot

STERLING ROPE WICKED GOOD ROPE WASH

This product is chemical free and will not break down any of the fibers in your rope. Keep your rope clean so that it will last longer. Rope should be washed approximately after 30-40 uses. Each packet has enough soap for one wash and can be used to wash your rope by hand, washing machine, or in a tub of water. 20 packets included in each order.

MDWASH20 - \$41.15



PMI BOKAT ROPE WASHER

Hook up to your hose, turn on the water, and pull the rope through the washer to scrub away dirt with the built-in brush. The water loosens dirt and the brush scrubs it off.

RC48002 - \$42.00

PMI ELECTRIC HOT KNIFE & ROPE CUTTER

This electric rope cutter hot knife may be used to cut rope and braided sleeving. Fusing rope ends also helps prevent unraveling after cutting the rope. Comes with 2-5/16" blade, operates on 110 AC volts, table top size, lighted on/off rocker switch, heats up to 1200°F, cuts and heat seals at the same time, 6.5' cord with ground.

RC48014 - \$134.00

RC48015 Replacement blades - \$20.00



PMI ROPE CORDAGE METER

Pull the rope through the meter the toothed measuring wheel and stainless steel pressure shoe assures uninterrupted no slip contact with the cordage. Features digital counter that adds or subtracts, resets to zero with one turn of knob, measures ropes and cordage from 1/4" - 3/4" diameter. Available in feet or metric measurements.

RC48003 Cordage meter - \$289.00

RC48004 Cordage feet - \$289.00

RC48006 Standard bracket - \$9.00

RC48005 Extended bracket - \$25.00





PETZL ROLL MODULE

Articulated protector with rollers designed to guide a moving rope and protect it from abrasion. Number of modules can be varied according to terrain. Includes (4) modules, (6) quick links, and carrying bag.

P49 - \$349.95



MSA SURETYMAN TERMINATION PLATE

For use with 5/8" three strand, double-braid, or kernmantle rope; provides a quick reusable field termination that eliminates the need for knots.

SRIW1000 - \$45.79



WESTFALL TERMINATION PLATE

Used to connect a rope to something without the use of knots or factory terminations; for use with kernmantle rope between 7/16" and 3/4" or three strand rope between 5/8" and 3/4", ANSI compliant.

7001 - \$50.99

CUSTOMER CHOICE



PETZL CATERPILLAR

Vertical and horizontal rollers guide the moving rope with a minimum of rubbing. Each module can be positioned independently to adapt to the terrain, includes 4 modules and 6 quick links.

P68 - \$146.95



PMI EDGE ROLLER SYSTEM

3 linked units with hard anodized aluminum side plates and two roller bars each. Can be used linked together with the furnished screw links at sharp edges, or separated for long gradual breakovers; 4" wide aluminum rollers and holes for permanent mounting.

HD26086 - \$225.00



PMI SPIROLL

Effective, economical protection for stationary ropes; rugged polyurethane material, single rope use, for ropes greater than 9.5 mm, perfect for anchors, easily movable, also available in black (RC48033)

RC48032 - \$12.00



PMI SUPERMANTLE ROPE PROTECTOR

Ballistic nylon exterior, canvas interior, easy open flap, reflective strip, tie off tab, 18"

RC48020 18" - \$22.75

24" - \$25.00

36" - \$33.50



MORROW GUIDE TO KNOTS

A compact, practical manual of (70) useful knots. From loops and bends to stopper knots and hitches, this guide includes step-by-step tying instructions, historical data, and useful tips.

BK13006 - \$18.99

* The ratings on these slings are the Minimum Break Strength (MBS), which is not a representation of their Working Load Limit (WLL), as they are not designed for maintaining a static load and are not intended for material handling.

BLUEWATER RHINO DUAL LAYER ANCHOR LOOP SLINGS

BlueWater Rope's Dual Sheath Armortech construction essentially creates a loop inside a loop; yellow outer for high visibility; fluorescent orange inner webbing to alert users of cuts or abrasions; custom Dyneema thread make overlap of sewn closure 1/3 the length of other slings. End to end: 11,000 lbf; choker: 10,000 lbf; basket: 15,000 lbf. Other lengths also available.

- 757002 24" - \$14.00
- 757003 36" - \$15.50
- 757004 48" - \$17.00
- 757005 60" - \$18.00
- 757006 72" - \$19.00



BLUEWATER ROPES 13 MM TITAN SLINGS

BlueWater Rope's 13 mm Titan Slings are constructed from Dyneema and offer the highest strength rating in the market. These slings are sewn with Spectra custom thread to ensure superior strength and performance. End to end: 6,000 lbf; choker: 5,000 lbf; basket 10,000 lbf.

- 763924S 24" - \$7.00
- 763948S 48" - \$12.50

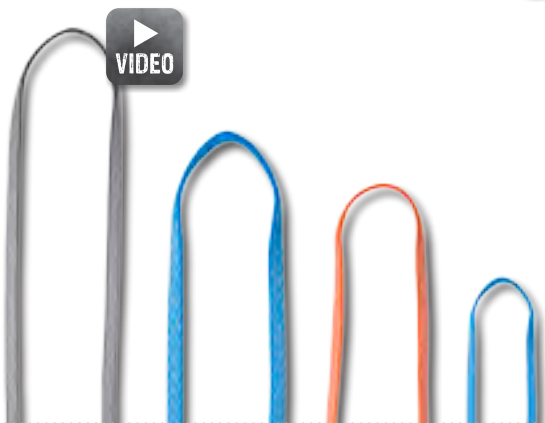

STERLING 12 MM DYNEEMA SEWN SLINGS

Dyneema slings offer significant performance advantages over traditional runners; they are lightweight, have high cut resistance, are extremely strong, and resist moisture; these features make them perfect for alpine climbing, MBS 5,170 lbs.

SW127DYSL

- +0610 10" Blue - \$6.85
- +0724 24" Orange - \$10.05
- +0630 30" Blue - \$13.05
- +0448 48" Black - \$15.60

STERLING 11/16" NYLON SLINGS

Sterling sewn runners are made with the highest quality webbing and computerized precision bar tacking making them exceptionally strong and lightweight, MBS 5,170 lbs.

SW174NYSL

- +1412 12" Silver - \$4.30
- +0624 24" Blue - \$5.30
- +1930 30" Neon green - \$5.90
- +1448 48" Red - \$7.85



PETZL ST'ANNEAU

Dyneema sling, lighter and more flexible than nylon slings, very abrasion resistant, 12 mm width. End to end: 22 kN; choker: 16 kN; basket 44 kN.

- C07 24 24 cm - \$7.95
- C07 60 60 cm - \$11.95
- C07 120 120 cm - \$16.95

PETZL FIN'ANNEAU

Ultralight dyneema sling, very abrasion resistant, 8 mm width., End to end: 22 kN; choker: 16 kN; basket: 44 kN.

- C06 60 60 cm - \$12.95
- C06 120 120 cm - \$17.95
- C06 180 180 cm - \$24.95

PETZL ANNEAU

Webbing loop, also available in black. End to end: 22 kN; choker: 16 kN; basket 44 kN.

- C40 60 60 cm - \$7.95
- C40 80 80 cm - \$9.95
- C40 120 120 cm - \$10.95
- C40 150 150 cm - \$13.95

GUARDIAN KERMANTLE HORIZONTAL LIFELINE

Temporary, reusable, two-person system designed for Fall Arrest applications. It includes (1) Kernmantle Rope, (1) Ultra-Sack storage bag, (2) O-rings, (2) cross arm straps, (1) rope tensioner, and (2) self-closing and self-locking carabiners; convenient, durable, and ideal for transporting equipment around the job site, and also offers protection from contaminants; (2) cross arm straps function as durable anchorage connectors that can be reused in multiple applications, 30'.

04638 30' - \$482.99

04639 60' - \$502.99

04640 100' - \$546.99



GUARDIAN CABLE HORIZONTAL LIFELINE SYSTEM

Designed to support up to (2) workers in fall arrest applications; includes 100' span of 3/8" diameter cable, (2) cross arm strap anchorage connectors, (1) web tensioner, (3) cable clamps, and (1) impact attenuator.

04800 - \$1008.99



SAFEMAZE HORIZONTAL ROPE LIFELINE KIT

2-person system kit includes Kernmantle rope, (2) carabiners, (2) connector rings, (2) cross-arm straps, energy absorber, steel tensioner, and carrying/transport bag.

FS805-60 60' - \$654.00

FS805-80 80' - \$705.00

FS805-100 100' - \$750.00



PROTECTA PRO-LINE TEMPORARY HORIZONTAL LIFELINE SYSTEM

60' lifeline with tensioner, shock absorber, bag, and (2) 6' tie-off adaptors, built-in shock absorber limits arresting forces during a fall and provides the user with a visual impact indicator, installs in seconds without special tools or equipment, fall arrest rated for two users, OSHA compliant.

1200101 - \$393.99

1200105 Without tie-off adapters - \$257.99

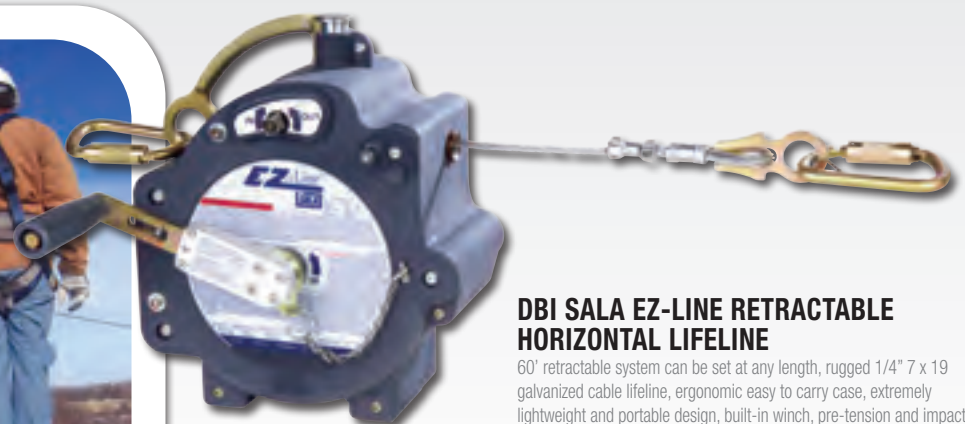

DBI SALA EZ-LINE RETRACTABLE HORIZONTAL LIFELINE

60' retractable system can be set at any length, rugged 1/4" 7 x 19 galvanized cable lifeline, ergonomic easy to carry case, extremely lightweight and portable design, built-in winch, pre-tension and impact indicators, durable construction will stand up to tough job sites, single and multi-span (with SecuraSpan stanchion) system configurations, internal energy absorber limits fall arrest forces, flexible system capacity, use with any 5,000 lb anchorage device, equipped with i-Safe.

7605060 - \$1,657.99



NEW



ISC HAULERBINER COMPACT RESCUE KIT

Mechanical Advantage System which has three pulley wheels built into each carabiner, creating a compact, lightweight 6:1/7:1 Mechanical Advantage System; features anti-tangle sock, with pulley wheels located well above/below the sock to prevent the sock from becoming jammed in the pulleys; has a purpose designed progress capture cam, with a positive on/off action; utilizes specially developed 6 mm (1/4") diameter rope, for strength, easy handling and grip; supplied in a double pocket pouch for easy deployment and storage on the user's harness. Available in three standard kit lengths, with bespoke lengths available on special order.

HB105A 105 cm - \$230.00

HB165A 165 cm - \$245.00

HB300A 300 cm - \$277.00



BLUEWATER MINI-HAUL KIT TACTICAL

4:1 mini-haul kit, includes multi-use technician bag with velcro belt type rear attachment, 35' tactical black 8 mm NFPA BlueWater Escape rope, polyester sheath, nylon core, 6 mm stainless steel quick link, 2 black double sheave mini pulleys, 1 with becket, 2 auto-lock Rock Exotica Pirate carabiners, 6 mm x 11" hybrid sewn prusik.

600235MH - \$135.00



CUSTOMER CHOICE



PETZL JAG HAUL SYSTEM

Haul kit for pick-offs, making a releasable anchor, or tensioning a system, thanks to its 4:1 mechanical advantage and excellent efficiency (sheaves with sealed ball bearings). The collapsed kit is very compact, making usage possible even if the distance to the anchor is very short. Kit is quick and easy to deploy: it is ready to use thanks to the flexible cover that prevents any risk of tangling. The haul end is color coded for instant identification.

P044AA00 1 m - \$299.95

P044AA01 2 m - \$324.95

P044AA02 5 m - \$399.95



ROCK EXOTICA AZTEK COMPACT SYSTEM

4:1 mechanical advantage, complete pre-rigged system with two Aztek pulleys, main 50' rope (8 or 9 mm), two Prusiks, a travel restrict Prusik and a compact bag to carry the pre-rigged kit in for rapid deployment. Can be used for pick off, travel restrict, adjustable directional, high directional guyline, load release hitch, and much more.

P41 KIT - \$337.99



PMI SMC ADVANCE TECH HAUL SYSTEM

Pre-rigged system provides either 4:1 or 5:1 mechanical advantage, built in progress capture, 10 meters of 9 mm PMI Classic Pro EZ-bend rope, max rope diameter 12.5 mm.

KT36158 - \$450.99



PMI / SMC JR HAUL SYSTEM

4:1 or 5:1 mechanical advantage, includes (2) mini JR pulleys, (2) aluminum carabiners, 10 m, 7 mm tuff cord; 2 m, 5 mm accessory cord; 5 mm oval screw link, bag.

KT36128 - \$201.99



STERLING ROPE POCKET HAULER

This perfect mini mechanical advantage system can literally fit in a pocket; creates a 4:1 or 5:1 increase in force depending on orientation, for use in partner/self rescue, adjustable directions, piggy-backed haul systems, tensioning lines and multiple other rigging needs. Kit includes: (2) SR mini-double pulleys, 50' of 8 mm rope with sewn eye, (2) Hawk auto-lock carabiners, and 6 mm sewn ratchet screw link.

KTPHAULER - \$245.45

KITS
SAVE
CASH



GME SUPPLY STANDARD RESCUE KIT

Kit includes PMI 7/16" Extreme Pro Rope with Unicore Technology, GME Supply Orange Waterproof Rope Bag, WestFall Pro D4 Descender, PMI Easy Pick-Off Strap, (4) WestFall Pro 07400 4-7/8" x 3" steel carabiners, BlueWater Rhino 3' Dual Layer Anchor Loop Sling, BlueWater Ropes 4' Titan Sling, BlueWater Ropes Mini-Haul Tactical Kit, and trauma shears.

9026 300' - \$829.99
9036 600' - \$1,129.99



GME SUPPLY TOWER Z RIG RESCUE KIT

Kit includes PMI 7/16" Extreme Pro Rope with Unicore Technology, GME Supply Orange Waterproof Rope Bag, WestFall Pro D4 Descender, BlueWater Rhino 3' Dual Layer Anchor Loop Sling, (4) WestFall Pro 07400 4-7/8" x 3" steel carabiners, Petzl Ascension Rope Clamp/Ascender Grab, BlueWater Micro Pulley, WestFall Pro 07437 4-7/8" x 3" aluminum carabiner, and trauma shears.

9027 300' - \$809.99
9038 600' - \$1,109.99



PMI EASY PICK-OFF STRAP

This high performance pick-off strap is designed to weigh less and be less bulky, but still perform when you need it; with a sewn anchor loop on the load end and a hand loop on the haul end, this strap allows for quick weight transfer from one system to another, adjustable length 7" to 42".

SG51180 - \$47.99



DBI SALA POLYESTER WEB PICK-OFF STRAP

Adjustable web strap intended for assisted rescue and industrial applications, often used with technical rope rescue type systems; designed with a 6:1 mechanical advantage; features leveraged lifting handle and swivel ring adjuster; compact and lightweight design.

8700578 - \$109.99



PMI LADDER RESCUE KIT

Kit includes Progress Capture pulley, 2" heavy duty black nylon webbing ladder, aluminum bar rungs sewn into ladder, Static 11 mm nylon rope, ClimbTech ANSI steel carabiner, and ballistic nylon deployment bag.

KT36164 - \$665.00



GME SUPPLY RESCUE KIT

Kit includes PMI 7/16" Extreme Pro Rope with Unicore Technology, GME Supply Orange Waterproof Rope Bag, WestFall Pro D4 Descender, PMI Easy Pick-Off Strap, (4) WestFall Pro 07400 4-7/8" x 3" steel carabiners, BlueWater Rhino 3' Dual Layer Anchor Loop Sling, and trauma shears. Upgrades available.

9024 150' - \$574.99

9025 300' - \$744.99

9035 600' - \$1,044.99

GME SUPPLY DELUXE RESCUE KIT

Designed for emergency pick-offs and rescue. Kit includes PMI 7/16" Extreme Pro Rope with Unicore Technology, GME Supply Orange Waterproof Rope Bag, WestFall Pro D4 Descender, PMI Easy Pick-Off Strap, (4) WestFall Pro 07400 4-7/8" x 3" steel carabiners, BlueWater Rhino 3' Dual Layer Anchor Loop Sling, WestFall Pro Chest Ascender, Rock Exotica Aztek Compact System, trauma shears. Upgrades available.

9050 300' - \$999.99

9075 600' - \$1,299.99

PETZL JAG RESCUE KIT

This reversible rescue kit is designed to easily pick off and lower a victim. Includes a Jag System Haul Kit, a Ring Open gated ring, an I'D S descender, a Connexion Fixe 150 cm anchor strap, a bucket bag, and an AXIS 11 mm rope with two sewn terminations.

K90030 30 m - \$759.95

K90060 60 m - \$849.95

K90120 120 m - \$999.95



GME SUPPLY BASIC RESCUE KIT

Kit includes 150' of 7/16" kernmantle rope, Sterling Small Rope Bag, WestFall Pro D4 Descender, PMI Easy Pick-Off Strap, (4) GME Supply 07405 4-1/2" x 2-3/4" steel carabiners, BlueWater Rhino 3' Dual Layer Anchor Loop Sling, WestFall Pro Rope End Termination Plate, and trauma shears.

09010 - \$499.99





DBI SALA ROLLGLISS RESCUE & DESCENT DEVICE

Offers the choice of controlled descent rescue, evacuation or the versatility of assisted rescue with lifting capabilities. This state-of-the-art, fully automatic controlled descent device can be used for rescue and evacuation from heights up to 1,640 ft (500 m) for one user 310 lbs (141 kg) or 575 ft (175 m) for two users totaling 620 lbs (282 kg). It features 3/8 in (9.5 mm) super static kernmantle rope, and is configured with connecting hardware at each end of the lifeline to operate in both directions. Kit includes 4 ft (1.2 m) anchor sling, two carabiners, carrying bag, and 3/8" (9.5 mm) super static kernmantle rope lifeline available in 100 ft, 200 ft, and 300 ft lengths.

- 3327100 100' - \$1,043.99
- 3327200 200' - \$1,263.99
- 3327300 300' - \$1,483.99



STERLING TOWER EMERGENCY DESCENT KIT

ANSI compliant, heat resistant (to over 900°F), user rated up to 310 lbs, slim profile and weighs less than 10 lbs. Kit includes PQD device with anti-panic feature, 2 ANSI certified carabiners, waterproof storage bag with shoulder strap, and 6 mm XTEC Technora rope with sewn eye termination.

- KTPDQ100 328' rope - \$739.99
- KTPDQ 394' rope - \$839.99
- KTRNR Raise & Rescue Kit - \$124.99



STERLING BUCKET EVACUATION KIT

The Bucket Evac kit is designed as a simple safe solution for getting to the ground in the event of a situation while working on an aerial lift. Kit includes, F3 descent control device, SafeD carabiner, 75 ft of 6.8 mm TVAC, steel double action snaphook, and storage bag. The F3 is a smaller, lighter version of the acclaimed, patent-pending Sterling F4™ descent control device. This device was designed to work with our 6.8 mm TVAC Technora cord to offer a lightweight, compact, emergency egress system. The F3 is engineered with a double-action lever to give a brake assist in the event of a "panic grab". The auto-brake feature allows for a fast and hands-free exit. This is the perfect device for bucket truck evacuations, or emergency rappels.

- KTF3TVAC23B - \$265.00



SKYLOTEC DEUS

Descent is hands free or managed via precise control dial with stop-go-speed function, even with heavy gloves. Built for safety, with multiple redundant brakes and speed limiting technology to guard against free fall. Operates in both directions so multiple people can be evacuated with only one device and without re-rigging. Ropes can be replaced easily so you can use different ropes for different tasks. ANSI compliant.

- A-370 - \$1,995.00



DBI SALA SELF RESCUE

A flexible device that attaches to your current safety harness and allows you to lower yourself to safety in the event of a fall from height. This simple, fast and effective rescue plan minimizes risk for you, your coworkers and emergency response personnel. Instead of wondering how long it will take to alert others to your fall, you can simply avoid all that and free yourself. Features universal harness attachment, EZ-Link D-ring for fast connections, 50' of 5.5 mm rope, assisted-rescue ring, descent device and rope spool, lightweight and low profile design, molded padding for comfort, equipped with i-Safe. Available in 50 ft and 100 ft.

- 3320030 50' - \$563.99
- 3320031 100' - \$665.99

FRENCH CREEK REMOTE PROMPT RESCUE

6'-12' extendable rescue pole, carabiner holding clip, 354-2Z twist-lock carabiner with 1" gate, 12" tagline, and bag.

- RPCC-12 - \$175.99



STARTING AT \$744.99

BUILD YOUR OWN RESCUE KIT

KITS SAVE CASH

ANCHOR STRAP



BlueWater Rhino Anchor Loop Slings



Guardian Premium Cross Arm Strap

ROPE



Sterling Rope 1/2" HTP Static With Eye



PMI 7/16" Extreme Pro With Eye

HARDWARE



GME Supply Carabiner Pack



WestFall Pro 07475 Spreader Bar



WestFall Pro 07430 Steel Carabiner



WestFall Pro 07400 Steel Carabiner

ROPE BAGS



GME Supply Premium Rope Bag

PMI Rope Pack

DESCENT DEVICE



Petzl Small I'D Descender



WestFall Pro D4 Descender



DBI Sala NoWorries Descender



Petzl Large I'D Descender



WestFall Pro D5 Descender



DBI Sala NoWorries Descender

PICK OFF



PMI Easy Pick-Off Strap



BlueWater Mini-Haul Tactical Kit

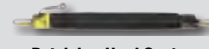

Petzl Jag Haul System



Rock Exotica Aztek Compact System



ISC Haulerbiner Rescue Kit

AVAILABLE EXCLUSIVELY AT GME SUPPLY www.gmesupply.com | (800) 940-6762



GME SUPPLY WIND RESCUE KIT

Designed for emergency pick-offs and rescue. Kit includes PMI Pickoff Strap, PMI Advance Tech Haul System, Petzl Small I'D Descender, Petzl Croll Chest Ascender, GME Supply Orange Waterproof Rope Bag, PMI 7/16" Extreme Pro Rope with Unicore Technology, (7) WestFall Pro 07436 4-7/8" x 3-1/8" aluminum carabiners, PMI 3" Premium Cross Arm Strap, Rock Exotica P22 Machined Rescue Pulley, Rock Exotica P21 Machined Mini Pulley.

9060 300' - \$1,250.00



GME SUPPLY TOWER RESCUE KIT

Designed for emergency pick-offs and rescue. Kit includes PMI Advance Tech Haul System, Petzl Small I'D Descender, Petzl Croll Chest Ascender, DBI Sala Orange Waterproof Rope Bag, Sterling Rope 7/16" HTP Static Rope with eye, (4) WestFall Pro 07400 4-7/8" x 3" steel carabiners, DBI Sala Rollgliss Rigmaster Anchor Strap, PMI Easy Pick-Off Strap.

9062 300' - \$1,245.00



**DBI SALA LAD-SAF X3
DETACHABLE CABLE
SAFETY SLEEVE**

Sleeve for Lad-Saf fixed ladder safety system; for use on 3/8 in. (9.5 mm) 1 x 7 or 7 x 19 solid core cable; easy installation and detach anywhere along lifeline; mechanical and inertial locking system stops falls within inches; built-in energy absorber and fall indicator with swivel; anti-inversion feature prevents incorrect installation; Saflok steel carabiner for secure connection to harness; extremely rugged, compact, lightweight, and corrosion resistant construction; integrated RFID tag, equipped with i-Safe.

6160054 - \$389.99

**DBI SALA LAD-SAF X2
DETACHABLE CABLE
SAFETY SLEEVE**

Sleeve for Lad-Saf fixed ladder safety system; for use on 3/8" (9.5 mm) and 5/16" (8 mm) 1 x 7 or 7 x 19 solid core cable; mobile design follows user for convenient climbing protection; easy installation and detach anywhere along lifeline; mechanical and inertial locking system stops falls within inches; built-in energy absorber and fall indicator; anti-inversion feature prevents incorrect installation; Saflok steel carabiner for secure connection to harness; extremely rugged and corrosion resistant construction.

6160030 - \$387.99

**MILLER VI-GO
AUTOMATIC PASS-
THROUGH CABLE
SAFETY SLEEVE**

For use with 5/16" or 3/8" diameter cable, automatically bypasses intermediate cable guides keeping both hands free for climbing, travels smoothly along cable and locks instantly in the event of a fall.

VGCS With swivel carabiner - \$401.49

With carabiner - \$452.99

**TUF-TUG CABLE
SAFETY SLEEVE**

For use with 3/8" diameter cable system, aluminum construction, self-tracking, hinged, two man safe operation, removable dual cam wire grab, automatic hands free climbing, meets ANSI ladder safety requirements.

TTWG-500 - \$139.00

**GME SUPPLY CABLE
SAFETY SLEEVE**

For use with 3/8" cable, comes with carabiner, works on both galvanized and stainless steel cables, meets ANSI, OSHA and CSA requirements for vertical lifelines.

RG-5000 - \$149.99

IN-STOCK, READY TO SHIP SAME DAY, CABLE SAFE CLIMB SYSTEMS



We inventory a large selection of Tuf-Tug stainless steel cable safe climb systems that are approved for installation by major tower site owners. These kits include all components required for common tower heights for Fixed Ladders, Monopoles, and Round Climbing Leg configurations. For further information, give one of our Gear Experts® a call.

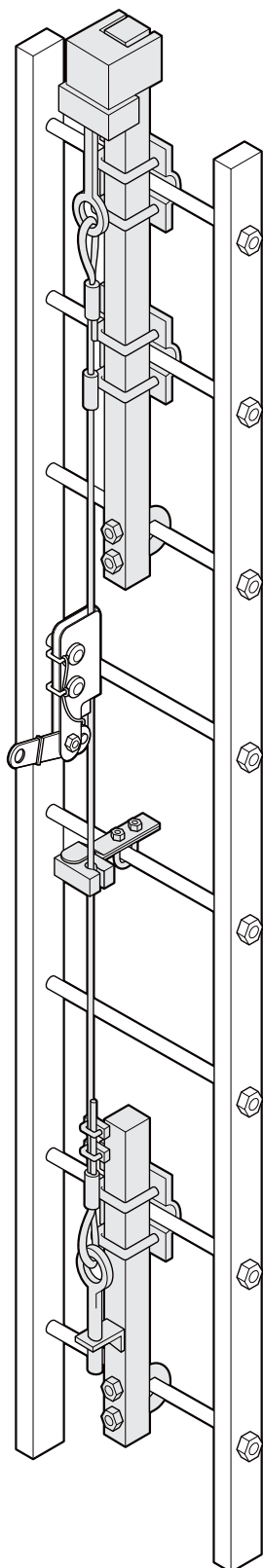

FIXED LADDER CABLE SAFE CLIMB SYSTEM

Includes: Stainless steel cable, factory swaged, and cut to length; Heavy duty upright mount bracket for solid rung ladders; Head assembly with impact attenuator; Ladder mount cable guides; Base anchor bracket assembly with tension adjustment eye bolt and cable clips. Quantity of components shown varies by system length.

TTCSCS-100'L-SSC - \$695.00

TTCSCS-200'L-SSC - \$825.00

TTCSCS-250'L-SSC - \$1,019.00

TTCSCS-300'L-SSC - \$1,150.00

TTCSCS-400'L-SSC - \$1,450.00



MONOPOLE CABLE SAFE CLIMB SYSTEM

Includes: Stainless steel cable, factory swaged, and cut to length; Head assembly with fasteners, spacer sleeves, and impact attenuator; Monopole cable guides; Monopole base anchor bracket with tension adjustment anchor bolt, cable clips, and fasteners. Quantity of components shown varies by system length.

TTCSCS-100'MP-SSC - \$495.00

TTCSCS-150'MP-SSC - \$669.00

TTCSCS-200'MP-SSC - \$805.00

TTCSCS-250'MP-SSC - \$990.00



ROUND CLIMBING LEG CABLE SAFE CLIMB SYSTEM

Includes: Stainless steel cable; Universal round leg head adaptor bracket (fits 1.5"-5" leg); Round leg universal clamp assembly up to 8" diameter; Head assembly with impact attenuator; Stud mount cable guides with fasteners; Base anchor angle attachment with tension adjustment eye bolt, thimble, and cable clips. Quantity of components shown varies by system length.

TTCSCS-150'RCL-SSC - \$999.00

TTCSCS-200'RCL-SSC - \$1,160.00

TTCSCS-250'RCL-SSC - \$1,395.00

TTCSCS-300'RCL-SSC - \$1,575.00





FRENCH CREEK VERTICAL FLEXIBLE CABLE CLIMBING SYSTEM

Includes top bracket, bottom bracket with tensioner, rung clamps for up to 1-1/8" diameter rungs, 3/8" galvanized wire rope lifeline permanently terminated at one end and clips on the other end. Standard lengths vary from 20' to 300' and include an appropriate amount of cable guides based upon length.

VL-38-20 20' - \$247.99

VL-38-50 50' - \$288.99

VL-38-100 100' - \$365.99

VL-38-150 150' - \$459.99

VL-38-200 200' - \$539.99



FRENCH CREEK WIRE ROPE GRAB

Stainless steel trailing wire rope grab for 3/8" wire rope.

1401-38 - \$174.49

1401A-38 With carabiner and shock absorber - \$192.49

DBI SALA LADDER GATE

Allows easy access by authorized personnel while preventing unauthorized use, heavy gauge aluminum shield, galvanized braces and hardware, continuous heavy duty piano hinge, fast and easy bolt-on bracket installation, built-in latch for padlock use, no special equipment required, authorized person simply unlocks your padlock on the ladder gate, swings the shielding gate aside and has unhampered access to the ladder; little or no maintenance required.

5901980 - \$1,369.99



DBI SALA RAILOK 90 FOR FIXED LADDER SYSTEM

DBI SALA TOP LADDER RAIL GATE

Aluminum and galvanized steel clamp with fastening hardware. Allows user to easily attach shuttle to the system and prevents accidental removal of the system.

6000352 - \$108.99

DBI SALA LADDER RUNG CLAMP

Aluminum and galvanized steel clamp with fastening hardware. Attached rail to ladder structure. Use within 1 ft of rail splice and one at least every 5 ft.

6000120 - \$56.99

DBI SALA STANDARD RAIL

Anodized extruded aluminum rail x 6.56 ft.

6000033 6.56 ft - \$60.99

DBI SALA RAIL JOINT

Aluminum and galvanized steel rail joint with fastening hardware. Attaches two rail sections together.

6000100 - \$58.99

DBI SALA RAILOK 90 SHUTTLE

Climbing shuttle automatically follows user and locks onto rail during fall.

6000377 - \$776.99

DBI SALA BOTTOM STANDARD RAIL GATE

Aluminum and galvanized steel clamp with fastening hardware. Allows user to easily attach shuttle to the system and prevents accidental removal of the system.

6000375 - \$122.99



MILLER SAF-T-CLIMB SHUTTLE

For use with Miller Saf-T-Climb Ladder System; provides total ladder climbing safety for workers above or below ground, straight or curved; immediately locks into the Saf-T-Notch rail as soon as a slip or fall occurs; integrated shock-absorbing element reduces fall forces on worker.

602-100-003 - \$642.99



FRENCH CREEK CLIMBING TROLLEY

For use with French Creek's rigid rail climbing system; provide maximum climbing safety for workers in a multitude of applications, such as towers, antennas, water tanks, scaffolds, support poles, dams, silos, ladders, and more; trolley moves freely along the rail until a slip or fall occurs; trolley then instantly locks and the fall is immediately arrested.

2-2100A-AT - \$274.99



DBI LAD-SAF FLEXIBLE CABLE LADDER SAFETY SYSTEM

DBI SALA STANDARD TOP BRACKET

Galvanized top bracket with mounting hardware, fits up to 1-1/8" rung diameter, attaches to (3) rungs, built-in energy absorber, for systems up to 499'.

6116280 - \$197.99

6116410 For systems over 500' - \$220.99

DBI SALA CABLE GUIDE

Non-metallic cable guide with mounting hardware, fits up to 1-1/8" rung diameter, must have one every 25', for systems up to 199'.

6100400 - \$44.99

DBI SALA CABLE LIFELINE

Galvanized cable, 3/8" (9.5 mm) diameter, 1 x 7 type. Last (3) digits in part number indicate length.

6110000 - \$1.43/ft

DBI SALA CABLE GUIDE

Non-metallic cable guide with mounting hardware, fits up to 1-1/8" rung diameter, for systems over 200'.

6100515 - \$43.99

DBI SALA LAD-SAF X3 FLEXIBLE CABLE SLEEVE WITH CARABINER

For use with 8 mm or 3/8" diameter 1 x 7 or 7 x 19 solid core cable. Comes with 2000112 carabiner. Meets OSHA and ANSI standards.

6160054 - \$389.99

DBI SALA STANDARD BOTTOM BRACKET

Fits up to 1-1/8" rung diameter, attaches to (2) rungs, tensioning device, galvanized.

6100090 - \$87.99

TRYLON COUGAR SAFETY CLIMB SYSTEM

ANSI-compliant and OSHA compliant, field-proven in extreme climates, excellent in confined spaces. Kits include appropriate length of aircraft cable, top and bottom support brackets, 12" tensioning turnbuckle, tension spring, and all hardware necessary for attachment to climbing ladders with ladder rungs up to 1.2" diameter. Intermediate cable guides included for 25' intervals.

4-99-0250-000 50' - \$423.99

4-99-0300-000 100' - \$544.99

4-99-0305-000 150' - \$665.99

4-99-0310-000 200' - \$690.99





CUSTOMER CHOICE

VIDEO

AB CHANCE CAPSTAN HOIST WITH FOOT CONTROL

1,000 lb load rating, 115 Volt AC, 40 ft/min rope speed, 14 amperes motor current, 45 lbs. (4) 3/8" mounting bolts are furnished with each unit, mounting flange provides (8) 3/8" tapped holes on 5-5/8" bolt circle.

C3081170 - \$2,139.99

C3081370 Rope speed 12 ft/min, 3,000 lbs load rating, 1/2" bolts - \$3,149.99



WATCH THE VIDEO ON OUR YOUTUBE CHANNEL

CHANCE

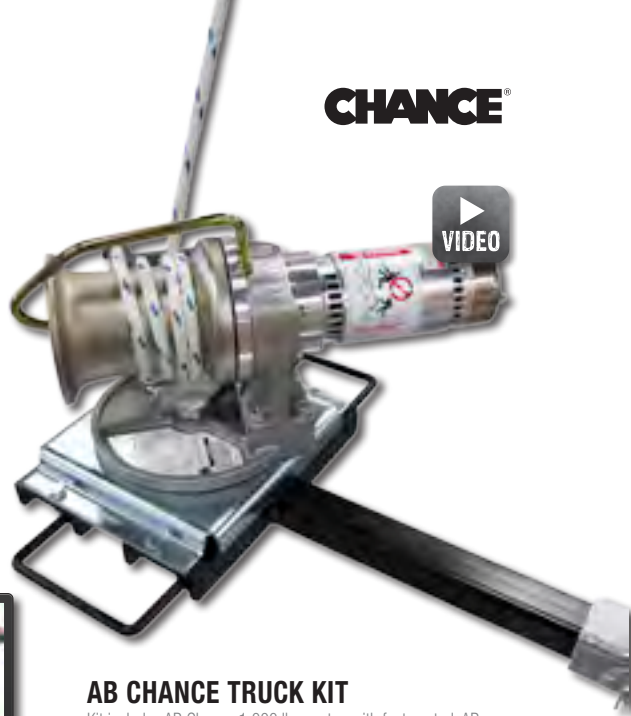

VIDEO

AB CHANCE TRUCK KIT

Kit includes AB Chance 1,000 lb capstan with foot control, AB Chance hitch mount, and AB Chance swivel and C-Bracket.

ESSENTIALKIT - \$2,764.99

ESSENTIALKIT/C3080856 With AB Chance rope lock - \$3,009.99



VIDEO

AB CHANCE HITCH MOUNT KIT

Includes C3080903, C3080890, and T3080999; provides fast mounting for 1,000 lb capstans.

PSC3081563 - \$684.99

T3080999 Hitch mount - \$294.99

C3088017 Hardware for attachment - \$9.99

T3081506 Swivel and C-Bracket - \$412.99

C3080903 Swivel bracket - \$299.99

C3080890 C-Bracket - \$114.99



AB CHANCE CHERRY SWITCH

Switch for AB Chance foot pedal.

P3080708 - \$29.95



VIDEO

AB CHANCE ROPELOCK

Rope lock device for Series 90 hoists, includes mounting bolts and washers.

C3080856 - \$154.99



AB CHANCE BRACKET

All-purpose bracket for 1,000 lb series 90 hoists, includes two chain clamps.

C3081335 - \$474.99

C3081443 For 3,000 lb series - \$529.99



MY-TE CAPSTAN HOIST

800 lb single-line or 1,600 lb double-line lift, 115 Volt AC or 12 volt DC brake motor with triple brake system for instant stopping, low voltage 10' pendant hand or foot control, heavy-duty angle base drilled for four 1/2" bolts (9/16" mounting holes) with no welding required, fully sealed aluminum housings with precision-cut gears run in an oil bath, hardened steel worm and forged bronze worm gear holds load in position when stopped, stress-proof drum shaft, frictionless bearings, 175:1.

30-12 12 volt DC - \$1,724.99

300AB 115 volt AC - \$1,919.99

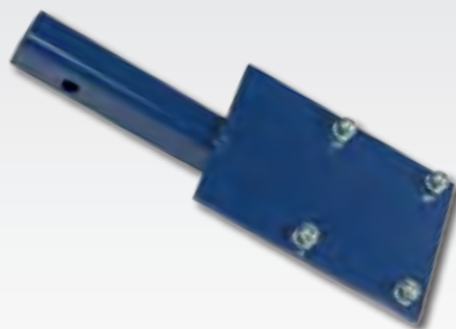

MY-TE RECEIVER HITCH MOUNT

Bolts to the capstan winch-hoist in order to mount the unit using a utility truck's 2" receiver hitch, shipped with hardware, hitch pin is not included, mounting plate may be used with any My-Te frame style capstan winch.

148452 - \$84.99

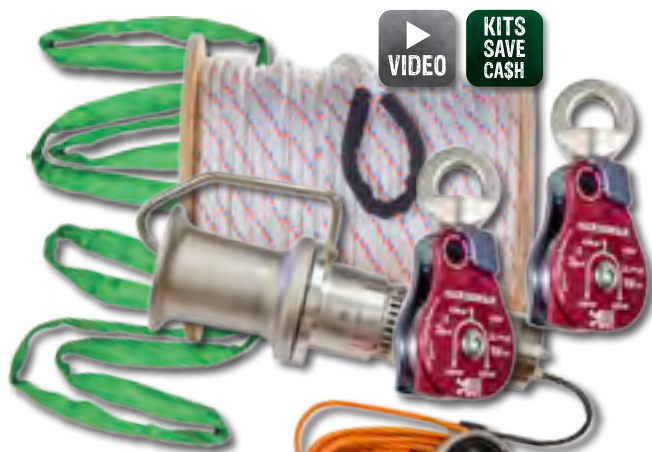

VIDEO
KITS SAVE CASH

AB CHANCE STRAIGHT MOUNT CAPSTAN TRUCK KIT

Kit includes AB Chance 1,000 lb capstan with foot control, AB Chance hitch mount kit, (2) Rock Exotica material handling 2.6" block, (2) LiftAll 4' green round slings, and 600' double braid rope.

CAPKIT6 - \$2,749.99

CAPKIT12 1,200' double braid rope - \$3,049.99



VIDEO
KITS SAVE CASH

AB CHANCE SWIVEL MOUNT CAPSTAN TRUCK KIT

Kit includes AB Chance 1,000 lb capstan with foot control, AB Chance hitch mount kit, (2) Rock Exotica material handling 2.6" block, (2) LiftAll 4' green round slings, and 600' double braid rope.

CAPKIT6S - \$3,349.99

CAPKIT12S 1,200' double braid rope - \$3,649.99



AB CHANCE CAPSTAN LABELS

These labels keep the user informed of the potential risks associated with using and operating a capstan. Includes (1) danger label and (1) warning label for use on C3081170 (1,000 lb capstan).

HB-RMD-1170 - \$9.95



AB CHANCE HEX KEY WRENCH

Hexagon key to 7/32 bolts.

Z030 - \$20.00



AB CHANCE REPLACEMENT ROPE HOOK

Prevents the rope or load line from slipping off the end of the capstan drum, acts as a guide by keeping the rope in the proper position while the capstan is operating.

P3081509 Hook - \$29.99

P3081517 Hook with tamper-resistant bolt - \$35.99



WELD-LOK REINFORCED STRAIGHT CAPSTAN MOUNT

Patent-pending design featuring reinforced Weld-Lok technology; strong, durable, and made for tough jobs; load rated at 1,000 lbs, engineered and manufactured in the U.S.

SM1170 - \$124.99

MY-TE SWIVEL MOUNT

Swivel mount bolts to your truck bed with (4) 1/2" bolts, capstan winch frame bolts to swivel mount using tapped mounting holes and hardware provided, winch rotation allows you to use your winch even when your truck is in an awkward location, pin stop locks swivel base in one position.

148331 - \$214.99



MY-TE POLE MOUNT ADAPTER

Sturdy steel construction with mounting bolts for mounting adapter to winch frame. Comes with chain tightener for securing to pole, allows same base-mounted unit to be used in either installation.

148353 - \$497.99





YOU DON'T HAVE ALL DAY

That's why we designed our Chance® Series 90 Captstan Hoists to be one of the fastest and quietest in the industry, pulling 40 feet per minute at full load. An improved design features a multiple-planetary drive/backstop clutch assembled on the center shaft of a steel gearcase with full-length internal teeth. This design handles more rugged jobs, extends service life and reduces maintenance.

At Hubbell Power Systems, Inc. our main focus is safety. Be sure you're practicing hoist safety by reviewing our Tips of the Trade at hpstips.com/hoist.

AD_09_056_E

CHANCE

ENDURING PRODUCTS & PEOPLE
YOU CAN DEPEND ON
hubbellpowersystems.com





ASME
B30
COMPLIANT

**CROSBY MCKISSICK
SYNTHETIC ROPE
BLOCK**

3" steel block with shackle top is used with 1/2" synthetic rope, 3" sheave diameter, and 2 ton working load limit.

8044078 3" - \$199.99

8048587 4.5" - \$376.99



WLL
4,500 LBF

VIDEO

ASME
B30
COMPLIANT

**ROCK EXOTICA
MATERIAL HANDLING
2.6" BLOCK**

Red side plate to easily differentiate material handling block from P55 omni-block pulley. Install and remove rope while still connected to the anchor; side plate locks with two-stage, double-catch safety mechanism; integrated swivel allows pulley to orient while reducing gain; 4,500 lbf WLL.

MHP55 - \$200.00



WLL
1,500 LBF

MADE IN
USA

ASME
B30
COMPLIANT

**TUF-TUG TOWER
TROLLEY TAG BLOCK**

1,500 lbs safe working load. Lifts loads to installation point. Self-tag trolley design. Used with 7/16" - 5/8" synthetic rope. Tracks load up tower with parabolic curve. Heavy duty made from solid steel, high visibility orange paint.

TTTB-1500 - \$295.00

**WESTFALL
PRO**

CUSTOMER
CHOICE

VIDEO

WESTFALL PRO LOAD LINE

The WestFall Pro Load Line is designed specifically for use with capstan hoists. This load line has a number of unique traits that set it apart from other double braid rope on the market.

Key Features: Unique sheath design gives it superior snag resistance and prevents particles and debris from penetrating the rope, extending the life and strength of the rope • Terminated ends for easy, versatile rigging options, no need for knots or termination plates which decrease rope strength • Protective sheath increases life of rope by protecting high-wear areas • High contrast tracers for increased rope visibility over other single color tracers • Improves perception of speed while lifting and lowering, seeing contrasting motion of orange and blue tracers makes it clear how fast rope is moving from hundreds of feet away • Durable serialized ID label for inspection tracking.



LENGTH	DIAMETER	STRENGTH	PART	PRICE
300'	3/8" (10 mm)	MBS 5,000 lbs	LL120300	\$125.00
300'	1/2" (13 mm)	MBS 11,000 lbs	LL160300	\$195.00
300'	5/8" (16 mm)	MBS 17,000 lbs	LL200300	\$300.00
600'	3/8" (10 mm)	MBS 5,000 lbs	LL120600	\$240.00
600'	1/2" (13 mm)	MBS 11,000 lbs	LL160600	\$380.00
600'	5/8" (16 mm)	MBS 17,000 lbs	LL200600	\$600.00
1,200'	3/8" (10 mm)	MBS 5,000 lbs	LL121200	\$480.00
1,200'	1/2" (13 mm)	MBS 11,000 lbs	LL161200	\$750.00
1,200'	5/8" (16 mm)	MBS 17,000 lbs	LL201200	\$1,200.00



ASME B30 COMPLIANCE

ASME B30 STANDARD FOR LIFTING & RIGGING

Chapter 26-5 of the ASME B30 Standard covers rigging blocks, like those that you'd use with a capstan hoist. Here's what you need to know about the standard*. Have more questions? Give our Gear Experts® a call!

MATERIALS

The block should be able to permanently deform before losing the ability to support the load. This ensures that you should notice the block has been overloaded before it falls.

Side plates should be of metal, wood, or a synthetic material. You'll almost always see steel or aluminum blocks in the tower industry. The sheaves and load-bearing straps or fittings should be made of metal, as well.

SAFE DESIGN FACTOR

Rigging blocks must have a minimum safety factor of 4.

RATED LOADS

Always keep your total load inside of the recommended limits set by the manufacturer. And

remember that this is the maximum load applied, not a single line load. Meaning if the block is rigged at the top of the tower and you're lifting something that weighs 1,000 pounds, there could be up to 2,000 pounds on the block. Check out competent rigger training courses for more on these concepts. (Page 204)

IDENTIFICATION

Each block has to have markings for manufacturer, rated load, and acceptable rope sizes. The block should also be maintained by the user to insure these markings remain legible through the life of the hardware.

TRAINING

Users must be properly trained to select, inspect, and fully use the blocks. That means not just in proper rigging, but also this very standard.

INSPECTION, REPAIR, & REMOVAL FROM SERVICE

A qualified person should designate whether the hardware is suitable for rigging, and remove from service if it's not. Prior to use, all blocks should be inspected to verify compliance with ASME B30. A visual inspection should be performed each time the block is used. Permanently installed rigging hardware should have periodic inspections as well.

Repairs or modifications must be specified by the manufacturer or a qualified person. The replacement parts should meet or exceed the original manufacturer specifications. Unless advised by the manufacturer, modifications are not recommended.

OPERATING PRACTICES

Obviously, load ratings should not be exceeded. Make sure you're keeping clear of the block, its running lines, load, or any other part of the system during lifting. That includes walking or standing under a suspended load, or lifting line. Also, don't stand next to the rigging when the line is under tension.

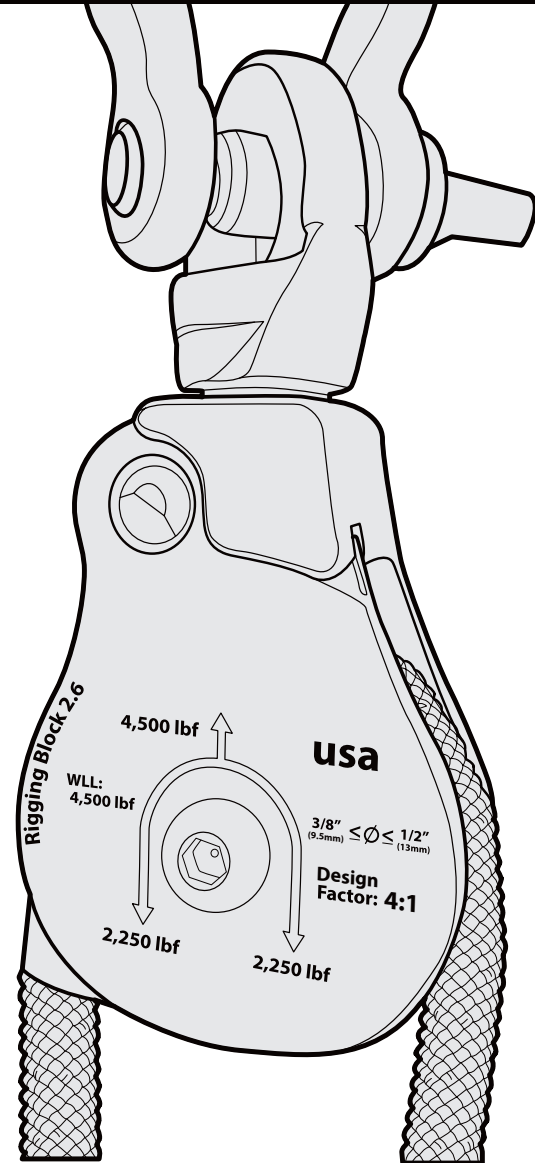

The load applied to the block should be in-line with the sheave to prevent side loading. Blocks with swivels help to avoid these problems. Also, make sure your rope is securely in the groove of the sheave. Shock loading should also be avoided.

*This is not a comprehensive training guide.

FREE
DOWNLOAD

ASME
B30
COMPLIANT

LOOK FOR THIS
BADGE THROUGHOUT
THE CATALOG.

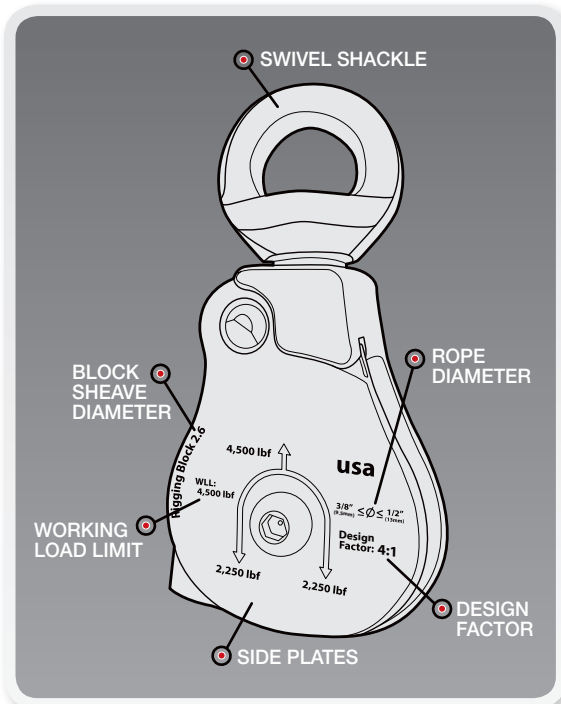

SWIVEL HOOKS

PART	WLL	PRICE
EH1TASLP	1 ton	\$25.20
EH112TASLP	1.5 tons	\$27.30
EH2TASLP	2 tons	\$31.50
EH3TASLP	3 tons	\$36.75
EH5TASLP	5 tons	\$42.00
EH7TASLP	7 tons	\$89.25



WESTFALL PRO SNATCH BLOCKS



PART	STYLE	WLL	SHEAVE	PRICE
2010	Hook	2 tons	3"	\$114.99
2000	Shackle	2 tons	3"	\$114.99
2015	Hook	4 tons	4.5"	\$199.99
2005	Shackle	4 tons	4.5"	\$189.99



WESTFALL PRO ALUMINUM SIDE-OPENING HAND LINE BLOCK

Aluminum alloy and magnesium block, lightweight design, excellent for use with capstan winches, load tested prior to shipment, for rope up to 7/8" diameter, rated 1,000 lbs.

B1000 3" - \$114.99

B2500 4" - \$364.99

BETHEA ALUMINUM TOP-OPENING HAND LINE BLOCK

3" aluminum alloy block, swivel eye and safety hook, permanently lubed and shielded ball bearings that operate on 5/8" steel axle, rated 1,250 lbs.

HLB1250SH - \$80.25

TUF-TUG ALUMINUM HAND LINE BLOCK

3" aluminum alloy block, safety hook, 1/2" maximum rope, 2,000 lb capacity.

ALSB2000H 3" - \$42.00

ALSB3000H 4" - \$80.50

CROSBY SNATCH BLOCKS



PART	STYLE	WLL	SHEAVE	PRICE
108038	Hook	2 tons	3"	\$175.99
109037	Shackle	2 tons	3"	\$176.99
108065	Hook	4 tons	4.5"	\$324.99
109064	Shackle	4 tons	4.5"	\$310.99



SNATCH BLOCKS

PART	STYLE	WLL	SHEAVE	PRICE
SB3H	Hook	2 tons	3"	\$47.25
SB3S	Shackle	2 tons	3"	\$47.25
SB3TB	Tailboard	2 tons	3"	\$44.75
SB412H	Hook	4 tons	4.5"	\$84.00
SB412S	Shackle	4 tons	4.5"	\$87.25
SB412TB	Tailboard	4 tons	4.5"	\$78.75
SB6H	Hook	8 tons	6"	\$141.75
SB6S	Shackle	8 tons	6"	\$148.00
SB6TB	Tailboard	8 tons	6"	\$115.50
SB8H	Hook	8 tons	8"	\$188.00
SB8S	Shackle	8 tons	8"	\$194.25
SB8TB	Tailboard	8 tons	8"	\$157.50



HUBBELL ALUMINUM TOP-OPENING HAND LINE BLOCK

3" aluminum alloy block, forged steel swivel-eye suspension ring, for rope up to 5/8" diameter, bronze oilite bearings, rated 1,250 lbs.

22301 - \$139.99

KEARNEY ALUMINUM SIDE-OPENING HAND LINE BLOCK

Rugged cast aluminum alloy, 3" sheave for rope up to 5/8" diameter, 1/2" axle and swivel bearing, forged hook with safety latch and swivel, rated 1,000 lbs.

303B2PJ - \$143.99

404B2PJ 4", rated 2,500 lbs - \$409.99

BUCKINGHAM OX BLOCK

Snatch block with integrated friction bar, for use with rescue, lower loads, snubbing loads, and raising loads; replaces standard hand line blocks, parted blocks and various snatch blocks; eye to Hook: 6,000 lb MBS; eye to Sheave: 10,000 lb MBS.

50061 - \$399.99

JET JLP LEVER HOISTS

PART	CAPACITY	LIFT	WEIGHT	PRICE
287301	3/4 ton	10'	17 lbs	\$259.00
287302	3/4 ton	15'	19 lbs	\$274.00
287303	3/4 ton	20'	22 lbs	\$289.00
287401	1-1/2 tons	10'	30 lbs	\$319.00
287402	1-1/2 tons	15'	34 lbs	\$349.00
287403	1-1/2 tons	20'	39 lbs	\$369.00
287500	3 tons	5'	43 lbs	\$449.00
287501	3 tons	10'	50 lbs	\$484.00
287502	3 tons	15'	57 lbs	\$539.00
287601	6 tons	10'	76 lbs	\$779.00
287603	6 tons	20'	91 lbs	\$909.00



JET JLH LEVER HOISTS

PART	CAPACITY	LIFT	WEIGHT	PRICE
376101	3/4 ton	10'	15 lbs	\$320.00
376102	3/4 ton	15'	17 lbs	\$359.00
376103	3/4 ton	20'	19.5 lbs	\$389.00
376201	1 ton	10'	15.25 lbs	\$334.00
376301	1-1/2 tons	10'	21.25 lbs	\$399.00
376302	1-1/2 tons	15'	25 lbs	\$424.00
376303	1-1/2 tons	20'	28.5 lbs	\$474.00
376501	3 tons	10'	37.5 lbs	\$624.00
376503	3 tons	20'	53 lbs	\$729.00
376601	6 tons	10'	72 lbs	\$984.00



JET JLH COMPACT LEVER HOISTS

PART	CAPACITY	LIFT	WEIGHT	PRICE
181205	1/4 ton	5'	3.5 lbs	\$189.00
181210	1/4 ton	10'	4.2 lbs	\$209.00
181215	1/4 ton	15'	5.25 lbs	\$229.00
181505	1/2 ton	5'	5.5 lbs	\$259.00
181510	1/2 ton	10'	7 lbs	\$289.00
181515	1/2 ton	15'	8.6 lbs	\$319.00



TRACTEL GRIPHOIST/TIRFOR WIRE ROPE HOISTS

PART	CAPACITY	WIRE ROPE	WEIGHT	PRICE
T 508D	2,000	30' of 5/16"	23 lbs	\$1,209.99
T 516D	4,000	60' of 7/16"	48 lbs	\$1,732.99
T 532D	8,000	30' of 5/8"	61 lbs	\$2,363.99



KLEIN TOOLS PARALLEL JAW GRIPS

Round inside-jaw contour for maximum contact to minimize cable deformation, lower jaw is serrated to firmly grip insulated cables and conductors, includes a latch that prevents the grip from falling, large diameter eye.



PART	MIN - MAX CABLE DIAMETER	MAX LOAD	JAW LENGTH	WEIGHT	PRICE
1685-20	.157" - .875" (4 mm - 22 mm)	4,500 lbs	2-1/2" (64 mm)	3 lbs	\$226.99
1685-31	.625 - 1.250" (16 mm - 32 mm)	7,500 lbs	4-1/2" (114 mm)	5 lbs	\$292.99

KLEIN TOOLS WIRE ROPE HAVEN'S GRIPS

Designed for use when light, compact grip is desired and where cable deformation is not a factor, gripping pressure of the knurled jaw is applied to 1/4" (6.35 mm) cable area, all 1625 series have a swing latch to help hold cable in the jaw.

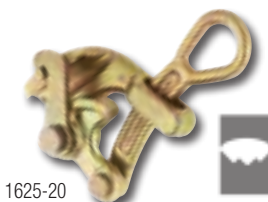

PART	MIN - MAX CABLE DIAMETER	MAX LOAD	WEIGHT	PRICE
1625-20	.28" - .75" (7.11 mm - 19.05 mm)	8,000 lbs	4 lbs	\$133.99
1625-20 7/8	.38" - .88" (9.65 mm - 22.35 mm)	8,000 lbs	4 lbs	\$154.99
1625-20 1	.50" - 1.00" (12.70 mm - 25.40 mm)	8,000 lbs	4 lbs	\$173.99

KLEIN TOOLS AIRCRAFT CABLE, MESSENGER, & GUY STRAND CHICAGO GRIPS

Double V grooves provide four-point contact, reducing chance of slipping and providing proper alignment of wire and cable (1684-5F is a Single V with file insert).

PART	HOT LATCH	SPRING	MIN - MAX CABLE DIAMETER	MAX SAFE LOAD	JAW LENGTH	WEIGHT	PRICE
1613-40	1613-40H	S1613-40H	.12" - .37" (3.05 mm - 9.40 mm)	4,500 lbs	4-3/16" (106 mm)	3 lbs	\$149.99
1684-5F	N/A	N/A	.16" - .550" (4.06 mm - 13.97 mm)	8,000 lbs	5" (127 mm)	6.25 lbs	\$448.99
1684-5	1684-5H	S1684-5H	.218" - .550" (5.54 mm - 13.97 mm)	8,000 lbs	5" (127 mm)	6.25 lbs	\$257.99
1692-5	N/A	N/A	.218" - .550" (5.54 mm - 13.97 mm)	8,000 lbs	5" (127 mm)	6.40 lbs	\$256.99
1684-74	N/A	S1684-74H	.218" - .550" (5.54 mm - 13.97 mm)	8,000 lbs	5" (127 mm)	6.30 lbs	\$259.99
1628-16	N/A	N/A	.31" - .62" (7.87 mm - 15.75 mm)	15,000 lbs	7-1/4" (184 mm)	15.30 lbs	\$504.99
1628-17	N/A	N/A	.50" - .75" (12.70 mm - 19.05 mm)	15,000 lbs	7-1/4" (184 mm)	16.30 lbs	\$641.99
1628-18	N/A	N/A	.75" - 1.00" (19.05 mm - 25.40 mm)	15,000 lbs	7-1/4" (184 mm)	15.70 lbs	\$643.99

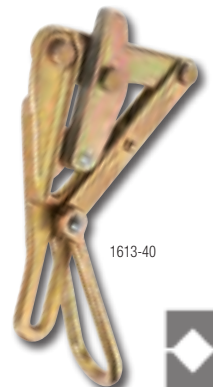

HARRINGTON LB MINI LEVER HOISTS

Harrington's LB lever hoists combine easy operation with a compact, low headroom design that easily handles real-world demands. Rated #1 selling lever hoist in the U.S., these hoists can be used horizontally, vertically, inverted, or at any other direction. Perfect for use in heavy-duty tower construction and maintenance, manufacturing, and day-to-day maintenance and repair. Rugged, all-steel construction; includes two brake pawls for additional reliability; moisture resistant brake pads; patented spring-loaded freewheel mechanism permits easy adjustment of the load chain and safeguards against accidental freewheeling under load; equipped with standard rubber grip for non-slip operation. Other capacities and lift heights available.

PART	CAPACITY	LIFT HEIGHT	HEAD ROOM	PULL TO LIFT LOAD*	NET WEIGHT	PRICE
LB008-10	3/4 tons	10	11 in	54 (36) lbs	13 lbs	\$510.90
LB008-15	3/4 tons	15	11 in	54 (36) lbs	13 lbs	\$565.10
LB008-20	3/4 tons	20	11 in	54 (36) lbs	13 lbs	\$622.70
LB015-10	1-1/2 tons	10	13.2 in	64 (45) lbs	18 lbs	\$695.90
LB015-15	1-1/2 tons	15	13.2 in	64 (45) lbs	18 lbs	\$764.80
LB015-20	1-1/2 tons	20	13.2 in	64 (45) lbs	18 lbs	\$812.20
LB030-10	3 tons	10	15.6 in	69 lbs	57 lbs	\$920.20
LB030-20	3 tons	20	15.6 in	69 lbs	57 lbs	\$1057.80
LB060-10	6 tons	10	21.3 in	78 lbs	88 lbs	\$1743.70

*Figures in parentheses are for hoists with the optional load limit warning handle



HARRINGTON LX MINI LEVER HOISTS

Harrington's LX lever pullers are ultra lightweight and compact yet extremely durable; Perfect toolbox hoists. Compact, low headroom design makes it ideal for use in tight quarters. Low pulling force required for ease of use. Rugged die-cast aluminum body with steel frame; grade 100, nickel-plated load chain is corrosion and wear resistant. Strong hook latches including notched tip.

PART	CAPACITY	HEAD ROOM	LIFT	WEIGHT	PRICE
LX003-5	1/4 tons	8.1 in	40 lbs	4 lbs	\$215.00
LX003-10	1/4 tons	8.1 in	40 lbs	9 lbs	\$234.10
LX005-5	1/2 tons	9.7 in	62 lbs	6.2 lbs	\$302.00
LX005-10	1/2 tons	9.7 in	62 lbs	11.2 lbs	\$321.70



HARRINGTON CX MINI HAND CHAIN HOIST

Harrington's CX mini hand chain hoist is uniquely compact and lightweight. Perfect choice for jobs with light loads in high or difficult to reach places. Aluminum body with steel frame provides superior strength. Very low force is required to lift load. Grade 100 nickel-plated load chain is corrosion and wear resistant. Durable stainless steel hand chain. Strong hook latches include safety tip.

PART	CAPACITY	HEAD ROOM	LIFT	WEIGHT	PRICE
CX003-10	1/4 tons	8.5 in	33 lbs	6.1 lbs	\$348.00
CX003-20	1/4 tons	8.5 in	33 lbs	10 lbs	\$641.00
CX005-10	1/2 tons	10.2 in	40 lbs	10.6 lbs	\$459.00
CX005-20	1/2 tons	10.2 in	40 lbs	16.4 lbs	\$758.00



HARRINGTON CF HAND CHAIN HOIST

Harrington's CF hand chain hoist provides a practical alternative thanks to an economical design using fewer parts for trouble free service. Outstanding durability is due to a die-cast aluminum body and high-strength, heat treated main pinion shaft and load gear. Pre-lubricated ball bearings, precision machined gears, and Weston-style load brake make lifting smooth and easy while allowing long service and low maintenance.

PART	CAPACITY	HEAD ROOM	LIFT	WEIGHT	PRICE
CF005-10	1/2 tons	12.8 in	60 lbs	24 lbs	\$272.00
CF005-20	1/2 tons	12.8 in	60 lbs	34 lbs	\$422.00
CF010-10	1 tons	14.6 in	72 lbs	32 lbs	\$321.00
CF010-20	1 tons	14.6 in	72 lbs	44 lbs	\$475.00
CF015-10	1-1/2 tons	17.3 in	84 lbs	40 lbs	\$467.00
CF015-20	1-1/2 tons	17.3 in	84 lbs	54 lbs	\$659.00
CF020-10	2 tons	20.1 in	80 lbs	45 lbs	\$534.00
CF020-20	2 tons	20.1 in	80 lbs	63 lbs	\$751.00
CF030-10	3 tons	23.2 in	92 lbs	60 lbs	\$805.00
CF030-20	3 tons	23.2 in	92 lbs	82 lbs	\$1,102.00



HARRINGTON PT MANUAL TROLLEY

Versatile, durable, and economical push trolley; maintenance-free sealed ball bearings provide smooth operation; assist in maneuvering loads easily; high strength and rigidity from a lightweight, compact design; easily adjust trolley to fit a wide variety of beam flange widths; load equalizing suspension distributes the load to all wheels; wide standard flange ranges reduce the need for optional extended shaft kits. 1/2 ton through 3 ton units are available. Geared trolleys of larger capacities also available.



PART	CAPACITY	WEIGHT	PRICE
PT005	1/2 tons	9 lbs	\$168.00
PT010	1 tons	15 lbs	\$224.00
PT020	2 tons	29 lbs	\$320.00
PT030	3 tons	46 lbs	\$490.00
PT050	5 tons	95 lbs	\$812.00
PT080	8 tons	212 lbs	\$2,152.00



GME SUPPLY SHACKLE PACK

Includes (2) Crosby 1/2" galvanized screw pin shackles, (4) Crosby 3/4" galvanized screw pin shackles, and (6) Crosby 5/8" galvanized screw pin shackles. These shackles are forged - quenched and tempered, with allow pins. Approved for use at -40° F to 400° F. Meets or exceeds all requirements of ASME B30.26. Statistical proof and impact tested. Proof testing and certification available upon request.

SHACKLEPACK - \$225.00



GME SUPPLY HEAVY DUTY SHACKLE PACK

Includes (2) Crosby 1" galvanized screw pin shackles, (2) Crosby 7/8" galvanized screw pin shackles, and (4) Crosby 3/4" galvanized screw pin shackles. These shackles are forged - quenched and tempered, with allow pins. Approved for use at -40° F to 400° F. Meets or exceeds all requirements of ASME B30.26. Statistical proof and impact tested. Proof testing and certification available upon request.

SHACKLEPACKHD - \$260.00

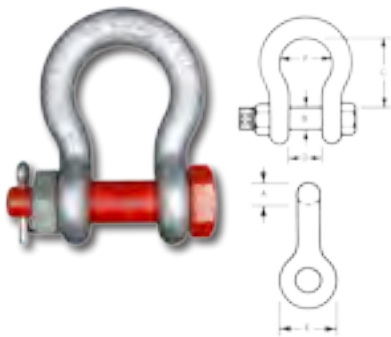

BOLT TYPE SAFETY SHACKLES



SIZE (A)	WLL	PIN (B)	(C)	(D)	(E)	(F)	PART	USA	PART	IMPORTED
3/8"	1 ton	7/16"	1.44"	.63"	.91"	1.00"	1019470	\$13.94	SHA38LRBT	\$3.15
1/2"	2 tons	5/8"	1.88"	.81"	1.31"	1.25"	1019472	\$24.65	SHA12LRBT	\$6.15
5/8"	3-1/4 tons	3/4"	2.44"	1.06"	1.56"	1.69"	1019490	\$34.90	SHA58LRBT	\$9.99
3/4"	4-3/4 tons	7/8"	2.88"	1.19"	1.88"	1.94"	1019515	\$50.40	SHA34LRBT	\$15.74
7/8"	6-1/2 tons	1"	3.38"	1.44"	2.13"	2.19"	1019533	\$70.40	SHA78LRBT	\$19.75
1"	8-1/2 tons	1-1/8"	3.81"	1.69"	2.38"	2.63"	1019551	\$95.00	SHA1LRBT	\$29.15
1-1/8"	9-1/2 tons	1-1/4"	4.25"	1.75"	2.63"	2.88"	1019579	\$123.90	SHA118LRBT	\$33.59
1-1/4"	13-1/2 tons	1-3/8"	4.69"	2.00"	3.00"	3.13"	1019597	\$168.00	SHA114LRBT	\$51.99
1-3/8"	17 tons	1-1/2"	5.31"	2.13"	3.25"	3.50"	1019613	\$225.00	SHA138LRBT	\$80.99

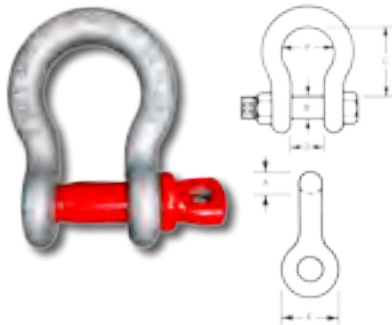

SCREW TYPE SAFETY SHACKLES



SIZE (A)	WLL	PIN (B)	(C)	(D)	(E)	(F)	PART	USA	PART	IMPORTED
3/8"	1 ton	7/16"	1.44"	.63"	.91"	1.00"	1018419	\$8.94	SHA38LR	\$3.15
1/2"	2 tons	5/8"	1.88"	.81"	1.31"	1.25"	1018455	\$12.10	SHA12LR	\$6.15
5/8"	3-1/4 tons	3/4"	2.44"	1.06"	1.56"	1.69"	1018473	\$22.60	SHA58LR	\$9.99
3/4"	4-3/4 tons	7/8"	2.88"	1.19"	1.88"	1.94"	1018491	\$32.50	SHA34LR	\$15.75
7/8"	6-1/2 tons	1"	3.38"	1.44"	2.13"	2.19"	1018516	\$44.90	SHA78LR	\$19.75
1"	8-1/2 tons	1-1/8"	3.81"	1.69"	2.38"	2.63"	1018534	\$60.60	SHA1LR	\$29.15
1-1/8"	9-1/2 tons	1-1/4"	4.25"	1.75"	2.63"	2.88"	1018552	\$88.00	SHA118LR	\$33.60
1-1/4"	13-1/2 tons	1-3/8"	4.69"	2.00"	3.00"	3.13"	1018570	\$126.40	SHA114LR	\$56.99
1-3/8"	17 tons	1-1/2"	5.31"	2.13"	3.25"	3.50"	1018598	\$164.50	SHA138LR	\$89.99



DILLON QUICK-CHECK TENSION METER

Can be placed on a cable to measure its tension and removed in under 5 seconds! Operator can quickly select from (20) different wire sizes and types stored in Quick-Check's memory, operating range -4°F to 140°F, tension units of measure include pound-force, kilogram-force, and Newtons, 2,000 x 2 lbf.

AWT05-508251 - \$4,389.99

36289-0014 10,000 x 10 lbf - \$2,499.99

ELECTRONIC DIGITAL THEODOLITE TRANSIT

Measures vertical and horizontal angles, vertical tilt sensor, reticle illumination, optical plummet, detachable tribrach, water resistant and dust proof to IP-54, dual backlit LCD display, and a six-button keypad.

56DGT10 - \$899.00



CROSBY JAW & JAW TURNBUCKLES

Heat treated bodies and quenched and tempered end fittings. Recommended for straight or in-line pull only. Meets or exceeds all requirements of ASME B 30.26. Forged jaw ends are fitted with bolts and nuts for 1/4"-5/8", and pins and cotters on 3/4"-2-3/4" sizes. Available in multiple lengths and end fittings.

1032554 1/2" x 6" - \$53.30

1032616 5/8" x 6" - \$77.00

1032670 3/4" x 6" - \$103.30



CROSBY JAW & EYE TURNBUCKLES

Heat treated bodies and quenched and tempered end fittings. Recommended for straight or in-line pull only. Meets or exceeds all requirements of ASME B 30.26. Forged jaw ends are fitted with bolts and nuts for 1/4"-5/8", and pins and cotters on 3/4"-2-3/4" sizes. Available in multiple lengths and end fittings.

1031939 1/2" x 6" - \$47.70

1031993 5/8" x 6" - \$66.00

1032055 3/4" x 6" - \$99.20



TUF-TUG TOTE TUGGER

Solid steel construction, heavy-duty, dual ratchet drive design; 7.5' reach, 3,000 lb pull capacity, 1,500 lb lift capacity, 3/16" cable diameter, folds into compact carrying case, folding handle.

TT3000-7.5C-FHB - \$49.99

TUF TUG LOAD RATED STEEL CARABINER

Dual action carabiner, 4-1/10" length, 2-1/5" width, 1/2" gate opening, 1,000 lb safe working load limit, for use with lifting and rigging applications.

TTMHC-1000 1,000 lb WLL - \$29.95

TTMHC-1500 1,500 lb WLL - \$32.95



TUF TUG LOAD RATED STEEL CARABINER

Dual action carabiner, 8-3/4" length, 5-2/3" width, 2-1/5" gate opening, 1,500 lb safe working load limit, for use with lifting and rigging applications.

TTXLMHC-1500 - \$69.99



DAS / LTE 2 INCH ANTENNA PIPE ROOSTER HEAD

Hoists DAS/LTE antennas up the tower into position for a quick and safe installation, slides into standard 2" pipe mount, max 250 lbs lift load capacity, 4" pulley with oversized groove, use with 1/2" diameter rope or 3/8" diameter wire rope.

TT2-APRH - \$189.99



ROCK EXOTICA ENFORCER LOAD CELL

Compact aluminum load cell that measures force up to 20 kN, lightweight aluminum construction, facilitates "in-line" use in rigging systems, swivel attachment points diminish potentially dangerous torsional and off-axis forces, features (2) sampling modes: "slow" for monitoring and "fast" for break-testing, monitor forces wirelessly on your iPhone with built-in Bluetooth connectivity, record and download graphs of dynamic events, measures force in kg, lbf, and kN.

LC1 - \$800.00



DILLON AP DYNAMOMETER

Generous shackle openings mate with most hooks and hardware, 0.5% accuracy, high specification materials on all load components, heat treated to tight tolerances, wide temperature range for use in nearly any environment.

30006-0027 1,000 lbs - \$965.00

30006-0050 5,000 lbs - \$1,020.00

30006-0076 8,000 lbs - \$1,180.00

30006-0084 10,000 lbs - \$1,349.99

30006-0092 15,000 lbs - \$1,449.99



DILLON ED JUNIOR DYNAMOMETER

Capacities from 2,500-25,000 lbs, generous shackle openings mate with most hooks and hardware, 0.2% accuracy, high specification materials on all load components, heat treated to tight tolerances, broadest range of capacities and resolutions are certain to fit your needs, NIST Traceable Certificate included, largest safety factor for overload protection and long life, 2 year warranty, includes high strength case that resists heavy blows.

AWT05-506319 - \$1,856.99



LIFTALL ENDLESS ROUND SLING

Continuous loop of 100% polyester fiber, double polyester woven jacket to protect the load-bearing fibers from damage. Each sling has a tough, resilient tag for quick and easy identification. Base prices are for 3' slings, longer lengths available.



PART	WIDTH	COLOR	VERTICAL	PRICE	+/FT
EN30X	0.6"	Purple	2,600 lbs	\$9.45	\$2.00
EN60X	0.8"	Green	5,300 lbs	\$11.25	\$2.55
EN90X	1"	Yellow	8,400 lbs	\$14.99	\$3.45
EN120X	1.2"	Tan	10,600 lbs	\$17.25	\$4.00
EN150X	1.3"	Red	13,200 lbs	\$21.99	\$5.30
EN240X	1.75"	Blue	21,200 lbs	\$33.99	\$7.65
EN360X	2"	Gray	25,000 lbs	\$74.99	\$11.55



LIFTALL POLYESTER EYE & EYE WEB SLING



PART	PLY	WIDTH	VERTICAL	CHOKER	BASKET	MIN. LENGTH	PRICE	+/FT
EE1801DFX	1	1"	1,600 lbs	1,250 lbs	3,200 lbs	3'	\$4.50	\$0.35
EE1802DFX	1	2"	3,200 lbs	2,560 lbs	6,400 lbs	4'	\$8.33	\$0.60
EE1803DFX	1	3"	4,800 lbs	3,840 lbs	9,600 lbs	4'	\$13.35	\$1.00
EE1804TFX	1	4"	6,400 lbs	5,120 lbs	12,800 lbs	4'	\$17.75	\$1.20
EE2801DFX	2	1"	3,200 lbs	2,560 lbs	6,400 lbs	3'	\$6.25	\$0.75
EE2802DFX	2	2"	6,400 lbs	5,120 lbs	12,800 lbs	3'	\$9.99	\$1.25
EE2803DFX	2	3"	9,300 lbs	7,440 lbs	18,600 lbs	4'	\$18.05	\$2.00
EE2804TFX	2	4"	12,000 lbs	9,200 lbs	23,000 lbs	3'	\$24.65	\$3.75

WIRE ROPE SLING



PART	WIDTH	VERTICAL	CHOKER	BASKET	EYE SIZE	MIN. LENGTH	PRICE	+/FT
14EEX	1/4"	.65 tons	.48 tons	1.3 tons	2 x 4	1'	\$11.29	\$1.00
516EEX	5/16"	1 tons	.74 tons	2.0 tons	2.5 x 5	1'	\$14.97	\$1.50
38EEX	3/8"	1.4 tons	1.1 tons	2.8 tons	3 x 6	2'	\$16.79	\$1.75
716EEX	7/16"	1.9 tons	1.4 tons	3.8 tons	3.5 x 7	2'	\$18.15	\$1.75
12EEX	1/2"	2.5 tons	1.9 tons	5.0 tons	4 x 8	2'	\$19.69	\$2.00
916EEX	9/16"	3.2 tons	2.4 tons	6.4 tons	4.5 x 9	2'	\$23.65	\$2.25
1EEX	1"	9.8 tons	7.2 tons	19.6 tons	5 x 10	3'	\$70.89	\$5.50

LIFTALL TUBULAR QUICK SLEEVE

These heavy polyester sling covers have velcro closures for quick and easy protection of round slings and/or load from damage.



PART	WIDTH	FITS RS SIZE	PRICE/FT
6TQS	6"	1 & 2	\$12.99
8TQS	8"	3, 4 & 5	\$17.99
10TQS	10"	6 & 7	\$21.99
12TQS	12"	8 & 9	\$23.99
14TQS	14"	10 & 11	\$34.99
16TQS	16"	12 & 13	\$38.99

LIFTALL 3" POLYESTER ENDLESS WEB SLINGS



PART	PLY	WIDTH	VERTICAL	CHOKER	BASKET	MIN. LENGTH	PRICE	+/FT
EN1801	1	1"	3,200 lbs	2,500 lbs	6,400 lbs	3'	\$3.99	\$0.75
EN1802	1	2"	6,400 lbs	5,000 lbs	12,800 lbs	3'	\$6.25	\$1.25
EN1803	1	3"	8,600 lbs	6,900 lbs	17,200 lbs	3'	\$9.99	\$2.00
EN1804	1	4"	11,500 lbs	9,200 lbs	23,000 lbs	3'	\$11.99	\$2.50
EN2801	2	1"	6,200 lbs	4,900 lbs	12,400 lbs	3'	\$7.88	\$1.50
EN2802	2	2"	12,200 lbs	9,800 lbs	24,400 lbs	3'	\$12.25	\$2.50
EN2803	2	3"	16,300 lbs	13,000 lbs	32,600 lbs	3'	\$18.64	\$4.25
EN2804	2	4"	20,700 lbs	16,500 lbs	41,400 lbs	3'	\$22.75	\$5.25

KITS
SAVE
CASH



GME SUPPLY RIG KIT

Save time and money with our rig kit. This rigging kit includes everything extra you need with capstan lifting and rigging applications. Kit includes (2) LiftAll 3' Endless Round Slings, (1) 1/2" WestFall Pro Load Line (choose length), (2) Rock Exotica MHP55 Material Handling Blocks, (2) 1/2" and (2) 5/8" Crosby Galvanized Screw Pin Shackles.

RIGKIT - \$677.99

GME SUPPLY RIG KIT XL

Save time and money with our extra large rig kit. This rigging kit includes everything extra you need with capstan lifting and rigging applications. Kit includes (2) LiftAll 3' Endless Round Slings, (1) 5/8" WestFall Pro Load Line (choose length), (2) Crosby McKissick 4.5" Block for 5/8" rope, (2) 1/2" and (2) 5/8" Crosby Galvanized Screw Pin Shackles.

RIGKIT-XL - \$1,1316.99

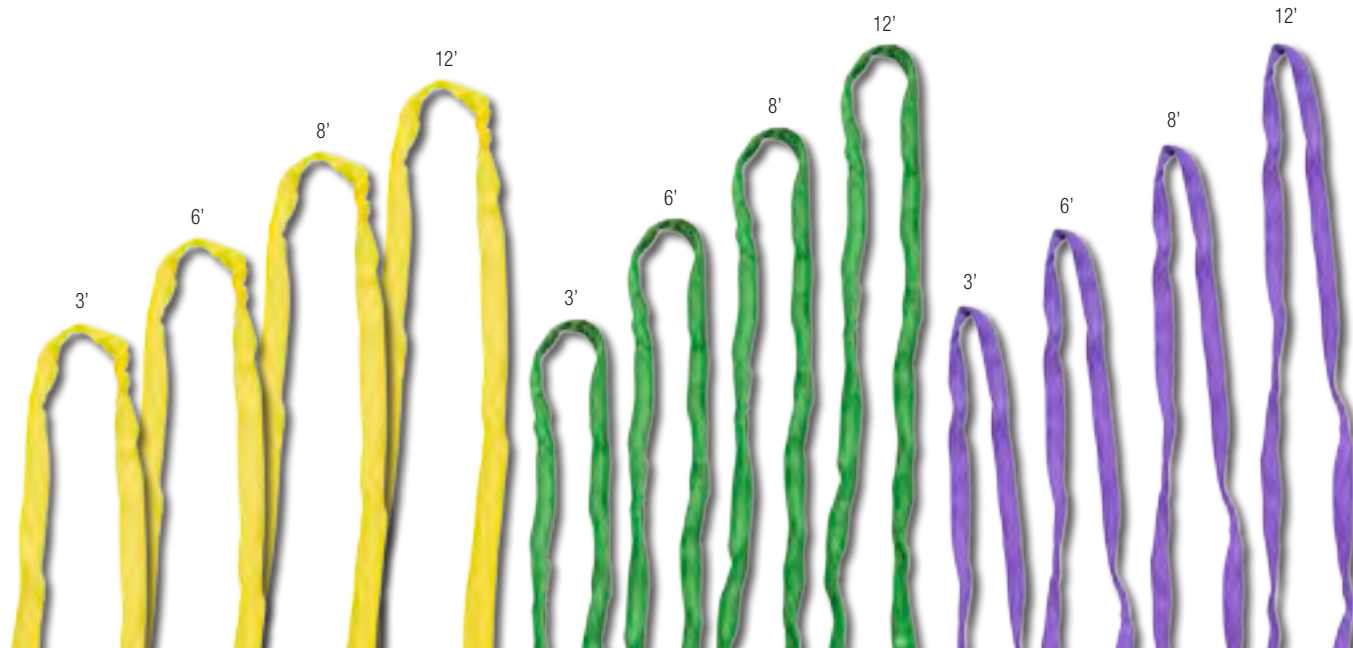

GME SUPPLY YELLOW SLING PACK

Includes (2) 3' Liftex ENR3 Yellow Round slings, (2) 6' Liftex ENR3 Yellow Round slings, (2) 8' Liftex ENR3 Yellow Round slings, and (2) 12' Liftex ENR3 Yellow Round slings.

GM-YELLOWSLINGPACK - \$209.99

GME SUPPLY GREEN SLING PACK

Includes (2) 3' Liftex ENR2 Green Round slings, (2) 6' Liftex ENR2 Green Round slings, (2) 8' Liftex ENR2 Green Round slings, and (2) 12' Liftex ENR2 Green Round slings.

GM-GREENSLINGPACK - \$159.99

GME SUPPLY PURPLE SLING PACK

Includes (2) 3' Liftex ENR1 Purple Round slings, (2) 6' Liftex ENR1 Purple Round slings, (2) 8' Liftex ENR1 Purple Round slings, and (2) 12' Liftex ENR1 Purple Round slings.

GM-PURPLESLINGPACK - \$129.99

**SUMNER NO. 60
SCREW-TYPE REEL
MAC REEL JACK**

Screw-type telescoping, for 26" to 56" diameter reels, height: 13"-27", capacity: 2,500 lbs, use with No. 61 spindle, self-lubricating bearings, built-in handle storage, patent pending safety head.

780941 - \$176.99



**SUMNER NO. 70
SCREW-TYPE REEL
MAC REEL JACK**

Screw-type telescoping, for 46" to 96" diameter reels, height: 21"-54", capacity: 2,500 lbs, use with No. 71 spindle, self-lubricating bearings, built-in handle storage, patent pending safety head.

780942 - \$244.99



**SUMNER NO. 75
ECONO MAC REEL
JACK**

Lighter design that does require any loose pins, Self-lubricating roller bearings, no grease required, one-bolt disassembly, no welding required for service, double pronged pins, 23.75" to 52.75" range, 2,500 lbs capacity.

780935 - \$218.99



**SUMNER NO. 71
SPINDLE FOR REEL
MAC**

Screw-type, diameter: 2-3/8", length: 76", capacity: 5,000 lbs, use with No. 70 Reel Mac Reel Jack, all steel construction, rugged design for job site use.

780230 - \$159.99

780229 For No. 61 reel stand 2-3/8" x 62" - \$124.99



**GREENLEE REEL
STAND SPINDLE**

Steel spindle with grooves to fit reel stand rollers, for 683 reel stand, 2-3/8" x 76" 5,000 lb capacity.

684 - \$259.99

647 For 687 reel stand 2-3/8" x 62" - \$198.99



**GREENLEE
JACKSTAND REEL
STAND ASSEMBLY**

Wide, welded steel base for added stability with 5/8" holes, roller bearings fit in the spindle groove to keep the spindle in place and turning freely, (2) stands and a spindle are required for a complete setup, 2,500 lb capacity, base 24" x 23", height 21" x 54".

683 - \$279.99



**GREENLEE
TELESCOPING REEL
STAND ASSEMBLY**

Wide, welded steel base for added stability with 5/8" holes, roller bearings fit in the spindle groove to keep the spindle in place and turning freely, (2) stands and a spindle are required for a complete setup, base 14.5" x 20", height 13" x 28".

687 - \$209.99





DBI SALA CYNCH-LOK FALL RESTRICTING POLE STRAP

Web distribution model, pole size (dia/circ): 5.5"/17.5" - 18.5"/58", 4.9 lbs.

1204075 - \$561.99

1204076 Web transmission model, pole size (dia/circ): 5.5"/17.5" - 30.5"/96", 5.4 lbs - \$607.99

DBI SALA CYNCH-LOK REPLACEMENT STRAP

Interchangeable replacement strap for distribution model Cynch-Lok.

1200110 - \$355.99

1200111 For transmission model - \$389.99

1200136 For web model - \$301.99



DBI SALA CYNCH-LOK FALL RESTRICTING POLE STRAP

Allows user to easily hitch-hike poles and move past obstacles, interchangeable exterior straps, pinch free, ergonomic grips, abrasion resistant rope guard, stopping cleat and carabiner restrict a fall during a cut-out, distribution model, pole size (dia/circ): 5.5"/17.5" - 18.5"/58", 4.8 lbs.

1204057 - \$546.99

1204058 Transmission model, pole size (dia/circ): 5.5"/17.5" - 30.5"/96", 5.3 lbs - \$614.99

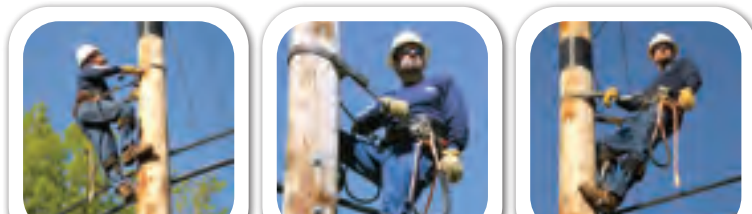

KLEIN TOOLS DELUXE FULL-FLOATING BODY BELT

Forged D-rings have corrosion-resistant finish, full-floating web strap, padded for maximum comfort, latigo-leather belt pad. Available in sizes 18D-30D.

5278N - \$299.99



KLEIN TOOLS INSULATED HIGH-LEVERAGE SIDE-CUTTING PLIERS

Clearly marked with the official 1,000 volt rating symbol, (2) layers of insulation provide protection against electric shock, integral finger guards.

D213-9NE-CR-INS - \$73.99



KLEIN TOOLS LINEMAN'S STRAIGHT CLAW HAMMER

Heavy-duty, double-duty hammer drives lags and pulls big nails, special high-carbon steel head with solid, octagon-shaped driving end and thick, strong claw.

832-32 - \$43.99

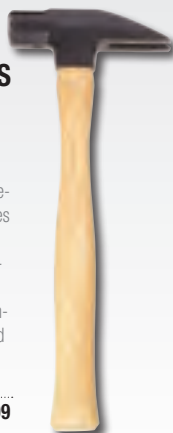

KLEIN TOOLS POLE CLIMBERS WITH GAFFS

Complete set, 1-9/16" gaffs, 8" x 8" cushioned, high-grade leather climbing pads, neoprene-impregnated nylon climber straps, secure sleeve and leg iron connection, 4-7/16" wide stirrup, contoured leg irons, 15"-19" adjustable length.

CN1986AR - \$298.29

CN1986ARL 17"-21" length - \$282.15



DBI SALA ARC FLASH NANO-LOK

Arc flash rated; built-in connector for single-leg SRL direct attachment to harness; 8' of 3/4" Kevlar fiber webbing lifeline; self-locking snaphook on lifeline; tough and impact resistant thermoplastic housing; swiveling anchorage loop, wide variety of configurations available.

3101527 - \$301.99



**DBI SALA
ADJUSTABLE
ROPE POSITIONING
LANYARD**

Abrasion resistant sleeve helps prolong product life, blue wear indicating core signals when product needs to be taken out of service, 2.2 lbs, 8' length.

1234070 - \$194.99



**DBI SALA EZ
STOP II ARC FLASH
SHOCK ABSORBING
LANYARD**

ARC rating: 40 cal/cm2, resistant to grease, oil and dirt; coated hardware for corrosion resistance, Nomex/Kevlar web loop at one end to reduce weight and electrical conductivity, twin leg design, self-locking snaphook at other end, 6' length.

1240536 - \$199.99



**DBI SALA
ADJUSTABLE WEB
POSITIONING
STRAP**

Double locking snaphook ends, 8,000 lb nylon strap webbing, built-in wear indicator shows a two-ply red core when frayed or worn, 6' length.

1204030 - \$192.99



**BUCKINGHAM
SUPERSQUEEZE WITH
WOVEN INNER STRAP**

Easy one handed outer strap adjustment, outer strap measures 36" and woven inner strap with carabiners measures 48", meets ASTM F887-11, and rated to 350 lbs.

488W2 - \$613.99

BUCKINGHAM BUCKALLOY ALUMINUM CLIMBERS

Non-contoured shank and offset stirrup with bevel and screw replaceable gaffs, includes standard length sleeves adjusting from 15 3/4" to 18 1/2".

A94059A - \$349.15

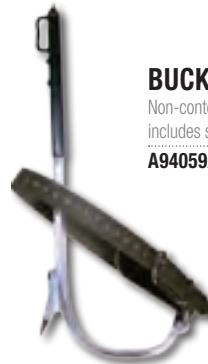

**KLEIN TOOLS
GENERAL
PURPOSE
INSULATED
TOOL KIT**

(2) layers of insulation provide protection against electric shock, comprehensive assortment of (22) insulated tools, piano-hinged cover has both a combination lock and two key-locked latches for security.

33527 - \$1,158.99



**PIP NOVAX
LEATHER GLOVE
PROTECTORS**

Cover glove to be used only for mechanical protection for rubber insulating gloves, top grain goatskin leather, available with gauntlet or driver cuff. Available in sizes 7-12 for Class 00-4 rubber insulating gloves, 10", 12", 13", or 14" length. Not to be used for electrical protection per ASTM F696-02.

148-1000 - \$14.99



**PIP NOVAX
RUBBER
ELECTRICAL
INSULATING
GLOVES**

Meets ANSI/ASTM D120 standard and NFPA 70E for use around electrical hazards and arc flash protection. Available in sizes 7-12 for Class 00-4 rubber insulating gloves, 11", 14", 16", or 18" length.

150-00-11 - \$49.99





ELK RIVER CONSTRUCTION PLUS ROOFER KIT

Complete roofer safety requirements in a convenient bucket, keeps you in full OSHA compliance. Kit includes: single D-ring harness (S-XL), 5/8" rope grab and snaphook, reusable roof anchor with nails, 50' x 5/8" Construction Plus lifeline with snaphook and thimble eye, 3.6 m gate. All contents meet ANSI A10.32-2004 and OSHA 1926.502.

05007 - \$108.99



PROTECTA ROOFER COMPLIANCE IN A CAN

Includes reusable roof anchor, 5-point harness, rope grab, and 50' lifeline; improved fit, updated colors, and durable yet lightweight construction; provides greater comfort and added safety which translates to reduced worker fatigue and increased productivity, 3,600 lb gated hooks, meets ANSI Z359.

2199803 - \$150.51



PROTECTA COMPLIANCE IN A CAN LIGHT ROOFER'S FALL PROTECTION KIT

Complete all purpose fall protection system in one handy container; lightweight FIRST harness with pass-thru buckle legs and 5-point adjustment (model 1191995); PRO 6' single-leg shock absorbing lanyard (model 1341001), durable bucket with handle; meets OSHA 1910.66 and OSHA 1926.502.

2199802 - \$73.99



GUARDIAN ROOFER KIT

Incorporates an integrated shock absorber into the lifeline, user will never have to worry about adding a shock absorbing lanyard to his fall protection system, by removing the shock pack from the worker's back less dead weight is transferred to the dorsal D-ring, comes in a variety of configurations. Includes HUV #01700, Temper reusable roof anchor #00455, and VLA-50' #01320; ANSI compliant.

00815 - \$115.99

DBI SALA FLEXIGUARD PORTABLE GUARDRAIL STANCHION

Fall protection in its simplest form – requires no special training or gear, mounts in both parapet and edge grab configurations allowing the use of a single base for multiple applications, clamp expands from 6" to 24", rapid clamp system speeds installation, supports both wood and concrete structures for added flexibility, durable zinc plated finish, supports both top and mid-rail guardrails, incorporates mounting locations for toe board for use in the edge grab configuration, designed to be used with standard wood 2 x 4's or other common guardrail material.

7901000 - \$209.99



LAKESIDE PLASTICS PERIMETER DEFENDER

Easy flag tie-off system, quick set-up and removal, stores easily, (2) mounting holes for warning lights or signs, UV resistant safety orange, non-conductive, 39" OSHA compliant tie off height 1926.502(f)(2)(ii), high-impact polyethylene, skid resistant, will not leave rust marks on roofs, rubber base will not damage surfaces, stackable with or without base, large grip handle for ease of transporting and handling, base made of 100% recycled rubber.

1041 - \$49.99



GUARDIAN SINGLE STANCHION

Specially designed for use with a reusable warning line, block worker from exposure to fall hazards, weighs only 23 lbs, 39" tall, composed of powder-coated steel for superior durability and weather resistance, easy to install and store, convenient handle facilitates simple transportation, maximum spacing 50' apart.

15225 - \$182.99

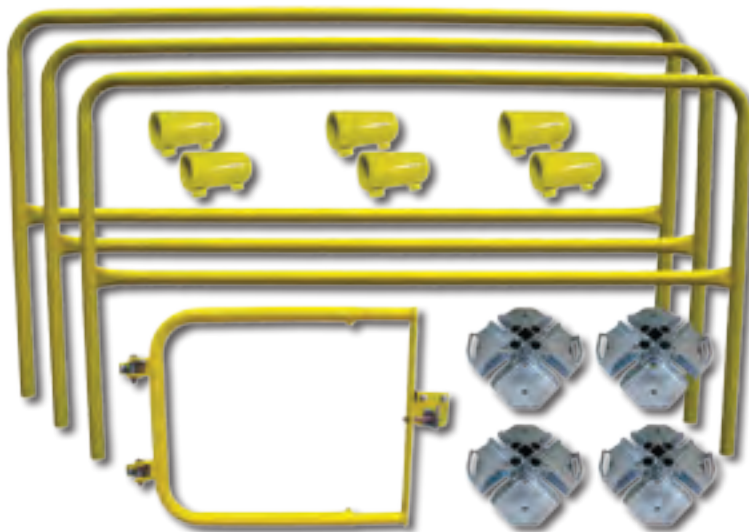

DBI SALA PORTABLE GUARDRAIL ROOF HATCH KIT

Powder coated, (4) guardrail bases #7900060, (3) 6' guardrail sections #7900061, (3) rail splice kits to customize length, swing gate #7900007, free-standing guardrail system doesn't require attachment to surface, simple set-screw design, compact and lightweight design, various lengths and individual components are available.

7900008 - \$1,982.99

7900060 Portable guardrail base - \$291.99

7900061 Portable guardrail, 6' section - \$172.99

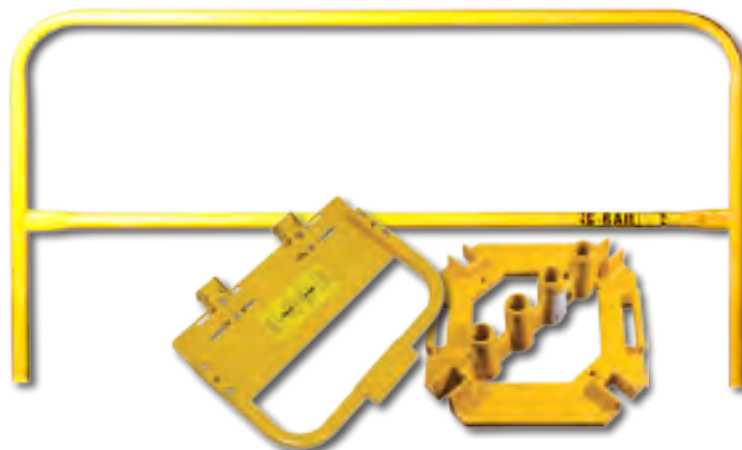

GUARDIAN GUARDRAIL

Part of the ultimate free-standing fall prevention system, block workers from exposure to fall hazards, made from powder-coated steel for supreme durability and weather resistance, compatible with both the multi-directional base plate and standard base plate options, meets all applicable OSHA & ANSI standards, powder coated safety yellow.

15183 42" x 6' - \$133.99

15182 42" x 8' - \$184.99

15181 42" x 10' - \$195.99

15178 Multi-directional guardrail base - \$256.99

15105 Guardrail safety swing gate - \$153.99

GUARDIAN REPLACEMENT FLAG LINE

Made from 100' of heavy-duty nylon cording and heat sealed flags. Flags spaced two feet apart for extra visibility. Compliant with Guardian Goose and Single Stanchions, Permanent Warning Line Masts, and can be used as a component of an OSHA compliant warning line system.

15231 - \$20.99



GAS CLIP MULTI GAS DETECTOR DOCK

All-in-one stand-alone docking station designed for maximum testing efficiency and portability; tests up to 4 units simultaneously, reducing testing time and gas usage; simple, two button design; optionally stored in rugged case or a wall mountable metal enclosure; logs are stored on a USB flash drive which can easily be transferred to a computer for analysis; test up to 12 instruments in a minute; internal gas cylinder regulator and pressure gauge; no computer required to operate.

MGC-DOCK - \$1,995.00



GAS CLIP MULTI GAS DETECTOR DOCK

All-in-one stand-alone docking station designed for maximum testing efficiency and portability; tests up to 4 units simultaneously, reducing testing time and gas usage; simple, two button design; optionally stored in rugged case or a wall mountable metal enclosure; logs are stored on a USB flash drive which can easily be transferred to a computer for analysis; test up to 12 instruments in a minute; internal gas cylinder regulator and pressure gauge; no computer required to operate.

MGC-DOCK-WM - \$1,995.00



GAS CLIP SINGLE GAS DETECTOR DOCK

All-in-one docking station designed for maximum testing efficiency and portability; housed in a rugged Pelican case; 2 GB USB memory; accurately test and record all monitor data; reduced testing time and gas usage; test 4 instruments simultaneously; test up to 12 instruments a minute; simple 1 button operation; robust rechargeable internal battery capable of testing hundreds of units before recharging; internal gas cylinder regulator and pressure gauge; can also be wall mounted.

SGC-DOCK - \$1,995.00



GAS CLIP CALIBRATION GAS

When calibrating your monitors with the SGC Dock or MGC Dock manually, use NIST traceable gas; Standard Quad gas mixture - H2S/25 ppm, CO/100 ppm, O2/18% vol. and CH4/2.5% vol. (50% LEL), 58 Liters

MGC-Q-58 - \$210.00

MGC-Q-116 116 L - \$310.00



GAS CLIP CONFINED SPACE KIT

Everything you need for remote sampling; includes: hard-sided carrying case with foam insert, 3 foot calibration hose with quick connect, hand aspirator pump, 10 foot sampling hose with quick connect, 1 foot sampling probe, IR data link, and a 0.5 lpm regulator. (MGC detector and gas sold separately)

MGC-CSK - \$465.00



GAS CLIP SINGLE GAS DETECTOR SPACE KIT

Ideal for any environment, adjustable alarm set points and real-time gas reading; 50% larger battery capacity; two-way IR comms for event downloads, bump tests and updates; programmable unit identification; visual, vibrating and audible alarms.

PART	GAS TYPE	RANGE	ALARM THRESHOLD	MEASURING	RESPONSE TIME	PRICE
SGC-C	CO	0-300 ppm	35/200 ppm	1 ppm	15 sec	\$169.00
SGC-H	H ₂ S	0-100 ppm	10/15 ppm	0.1 ppm	15 sec	\$169.00
SGC-O	O ₂	0-0.3 Vol.-%	19.5/23.5 Vol.-%	0.1 Vol.-%	15 sec	\$169.00



GAS CLIP MULTI GAS DETECTOR

Detects presence of combustible gases, H₂S, CO, and O₂; 2 month battery life (continuous run time); 6 month calibration cycle; will work in inert environments, no need for oxygen; simple to use; bump/calibration reminders; docking station compatible; programmable user ID. Available with or without sampling pump. Gases Detection Range: H₂S: 0-100 PPM, CO: 0-500 PPM, Combustible: 0-100 %LEL, O₂: 0-30%

PART	DESCRIPTION	GAS TYPES	PRICE
MGC	Multi Gas Clip with Infrared Combustible Sensor (4 Gas)	H ₂ S, CO, O ₂ LEL	\$745.00
MGC-P	Multi Gas Clip with Pellistor Combustible Sensor (4 Gas)	H ₂ S, CO, O ₂ LEL	\$595.00
MGC-2	Multi Gas Clip with Infrared Combustible Sensor (2 Gas)	O ₂ LEL	\$595.00
MGC-2-P	Multi Gas Clip with Pellistor Combustible Sensor (2 Gas)	O ₂ LEL	\$445.00



ELK RIVER ECONOMY EZE-MAN CONFINED SPACE SYSTEM

Includes Deluxe EZE-Man winch 3:1 ratio, tripod pulley, tripod head assembly, tripod leg assembly, one auto-lock carabiner, yoke, tote bag, tripod bag, winch bag, harness bag, five D-ring universal harness, rope grab with lanyard, nylon rope lifeline.

05611 25' - \$2,016.99

05612 50' - \$2,197.99

05613 75' - \$2,278.99

05614 100' - \$2,317.99



FRENCH CREEK CONFINED SPACE TRIPOD

7' aluminum tripod, (2) attachment points on head, designed to withstand 5,000 lbs of vertical load, lightweight and portable, quick and easy single person setup, adjustable/locking aluminum legs, safety chain, non-slip rubber safety shoes.

TP7 7' - \$547.99

TP9 9' - \$608.99

S50G-7 7' with RG50 rescue unit - \$1,903.99

S50G-9 9' with RG50 rescue unit - \$2,029.99



FRENCH CREEK 3-WAY SELF-RETRACTING LIFELINE

50' galvanized wire rope; manufactured with rugged, lightweight cast aluminum housing; includes a mounting bracket for tripod or davit systems used for raising, lowering, for rescue or retrieval; uses friction brake that prevents the crank handle from free-wheeling while under load.

R50G - \$1,375.00



DBI SALA ADVANCED ALUMINUM TRIPOD WITH SALALIFT II WINCH

7' aluminum tripod (model 8000000), telescoping adjustable locking legs, built-in pulley system, specialized safety shoes and leg support chain, integrated 5,000 lb. eye bolt anchor points, manually operated winch (model 8102001), 60' of 1/4" galvanized steel wire rope, 6:1 gear ratio mechanical advantage, free-wheel mode, built-in fall protection, overload clutch, swiveling snaphook with impact indicator, quick-connect winch/SRL mount bracket, equipped with i-Safe.

8300030 - \$3,247.99



FRENCH CREEK MANUAL RETRIEVAL WINCH

50' galvanized wire rope; manufactured with rugged, steel frame and drum; unit includes a #45 pulley and carabiner for attaching the line to an anchor; friction brake prevents unit from free-wheeling when under load.

MW506 50' - \$175.00

MW100G 100' - \$705.00



ALLEGRO 8" COM-PAX-IAL BLOWER WITH CANISTER

This versatile system features the 8" COM-PAX-IAL blower with 25' of ducting; designed with the quick-connect clipping system which allows workers to attach the canister, tools-free, to the input side for powerful extraction or output side for ventilation; ducting stores conveniently within the canister; compact blower designed for easy use and storage without sacrificing airflow; polyethylene housing and canister assembly; lightweight, corrosion; UV and chemical resistant; safety orange color for easy visibility; bottom enclosure to protect electrical components; carry handle molded into blower and canister housing; steel powder coated grill.

9533-25 - \$381.99

DBI SALA SEALED-BLOK SELF RETRACTING LIFELINE - RETRIEVAL / BRACKET

50 ft of 3/16" galvanized steel wire rope with swivel snap hook; 3-way retrieval winch and mounting bracket; anchorage carabiner; 4 ft cable tie-off adapter; environmentally sealed dynamic components; 3-way emergency retrieval system; integrated quick-mount bracket; extremely durable construction; Fast-Line cable lifeline replacement system; Fast-Line means lifetime field recertification; anti-ratcheting locking system; built-in carrying handle; large pivoting anchor loop stays in line with load for added security and allows use of a variety of connecting hardware; swiveling snap hook with impact indicator; large pivoting anchorage loop; reserve lifeline system; i-Safe equipped.

- 3400853 30' - \$3,302.99
- 3400923 50' - \$3,896.99
- 3400871 85' - \$4,862.99
- 3400976 130' - \$6,085.99



DBI SALA VEHICLE HITCH MOUNT SLEEVE

Designed to install into a 2" hitch receiver on an attendant vehicle to provide a portable anchor point for confined space entry/retrieval, rescue, and fall-arrest systems; various sockets, extensions and accessories available.

8510140 - \$1,388.99



ADVANCED CARRYING BAG FOR 5-PIECE DAVIT HOIST

Set of 2 carrying bags for Advanced 5-piece Davit Hoist; lightweight and durable polyester construction; built-in web carrying handles; heavy-duty zipper closure; vinyl coated liner; easily move your davit system from one location to another; protect your asset with an easy to care for and long lasting bag.

8518513 - \$300.99



RESCUE/RETRIEVAL Y-LANYARD WITH SPREADER BAR

2 foot in length; D-ring at center and snap hooks at leg ends; keeps victim upright during rescue; abrasion resistant polyester webbing; built-in spreader bar; user friendly self locking snap hooks; high strength D-ring tie-off point; Equipped with i-Safe.

1231460 - \$119.99



ADVANCED DIGITAL 100 SERIES WINCH

Manually operated winch for use with tripod or davit rescue system; galvanized steel wire rope; 9:1 and 4:1 gear ration mechanical advantage; quick mount bracket; built-in digital usage indicator; triple redundant braking system; break wear indicator; durable corrosion resistant construction; sealed bearings at all contact points; integral carrying handle; swiveling snap hook with impact indicator; power drive option available, 60' length.

- 8518560 60' - \$2,840.99
- 8518561 90' - \$2,858.99
- 8518581 140' - \$3,619.99
- 8518582 190' - \$3,646.99
- 8518603 240' - \$4,482.99



DBI SALA ADVANCED 5-PIECE DAVIT HOIST SYSTEM

Adjustable offset upper davit mast; telescoping reach of 11-1/2" to 27-1/2"; adjustable vertical height of 33" to 43"; built-in primary and secondary pulleys; quick mount winch/ SRL bracket; detent and knob style adjustment; 33" lower davit mast extension; combine up to 2 extensions; 3-piece adjustable portable base adjusts from 37" to 64"; unique foot level and height adjustment system; designed for manhole and confined space entry/retrieval applications; constructed of lightweight materials including high-strength aluminum; davit pivots for ease-of-rescue and has adjustment for overhead clearance restrictions; lower base adjusts to fit most standard entries.

8518000 - \$5,402.99



EXCLUSIVELY FROM GME
**STRONG,
 DURABLE,
 NOSE BAGS**



**GME SUPPLY
 LEATHER BOTTOM
 CANVAS BUCKET**

17" height, 12" diameter, made of heavy-duty canvas, high-density polyethylene top ring for strength and chemical resistance, reinforced high-strength webbing strap, black leather cuff at bottom extends 3" up the side, inside pocket measures 8" x 8", made in the USA. Load rated 100 lb.

GM-5105 - \$61.99

**GM-5104S With swivel
 snaphook - \$64.99**



**GME SUPPLY
 PLASTIC BOTTOM
 CANVAS BUCKET**

15" height, 12" diameter, load rated 110 lbs, made of heavy-duty canvas, high-density polyethylene top ring for strength and chemical resistance, reinforced high-strength webbing strap, black molded polypropylene bottom, made in the USA.

GM-5110 - \$36.99

**GM-5109S With swivel
 snaphook - \$39.99**



**GME SUPPLY
 LEATHER BOTTOM
 BUCKET WITH
 CONNECTION POINTS**

17" height, 12" diameter, leather bottom bucket with velcro top, 2 inside pockets, and 4 inner D-rings.

GM-5104VTPD - \$94.99



**GME SUPPLY MINI
 LEATHER BOTTOM
 BUCKET**

6" height, 5" wide, black leather-reinforced bottom, heavy-duty natural canvas, high-strength webbing handle, makes great gift.

GM-5104MINI - \$15.99



**KLEIN TOOLS HARD
 BODY OVAL BUCKET**

10" height, 14" length, 7" width, (15) inside pockets, leather skinning knife sheath, non-conductive plastic exterior.

5144HBS - \$69.99



**KLEIN TOOLS TAPERED
 WALL CANVAS BUCKET
 WITH 15 POCKETS**

12" top diameter, 9" bottom diameter, (15) inside pockets.

5172PS - \$76.99



**KLEIN TOOLS
 VINYL BUCKET TOP**

Compatible with 5104 and 5109 series buckets, closure with velcro brand fasteners, and safety strap loop to ensure connection to bucket.

5110P - \$14.99

KLEIN TOOLS



KLEIN TOOLS WIDE-OPENING STRAIGHT WALL CANVAS BUCKET

15" height, 12" diameter, black molded polypropylene bottom, high-density polyethylene top ring, rope handle.

5109 - \$40.99

5109P With inside pocket - \$43.99

5109S With swivel - \$46.99

5109PS With inside pocket & swivel - \$52.99

5109SLR With swivel snaphook - \$52.99

KLEIN TOOLS HEAVY DUTY TOP CLOSING CANVAS BUCKET

17" height, 14" diameter, load rated 150 lbs, top zipper closure, leather bottom.

5104CLR17 - \$102.99

5104CLR22 22" height - \$117.99

KLEIN TOOLS LEATHER BOTTOM LEATHER BOTTOM CANVAS BUCKET

17" height, 12" diameter, leather-reinforced bottom, inside pocket, polypropylene-rope handle reinforced with leather for water resistance and strength.

5104 - \$74.99

5104S With swivel - \$81.79

KLEIN TOOLS LEATHER BOTTOM BUCKET WITH CONNECTION POINTS

17" height, load rated 100 lbs. Six small D-rings sewn in the interior provide secure connection points for tethers, extra large hook fits onto large-sized rigging equipment.

5104OCTO - \$99.99



KLEIN TOOLS MINI LEATHER BOTTOM BUCKET

6" height, 5" width, miniature version of 5104 bucket, leather-reinforced bottom, heavy duty natural canvas, rope handle, great gift for tower climbers, riggers, contractors, and more.

5104M - \$14.95

KLEIN TOOLS TAPERED WALL CANVAS BUCKET

13" height, 12" top diameter, 9" bottom diameter, black polypropylene bottom, high-density polyethylene top ring, polypropylene-rope handle reinforced with leather for water resistance and strength.

5113 - \$43.99

5113S With swivel - \$49.99

KLEIN TOOLS STRAIGHT WALL CANVAS BUCKET

14" height, 9" diameter, black molded polypropylene bottom, high-density polyethylene top ring, rope handle.

5106 - \$37.99

5106P (2) inside pockets - \$47.99

5106S With swivel - \$44.99

KLEIN TOOLS TAPERED WALL CANVAS BUCKET

12" height, 12" top diameter, 9" bottom diameter, swivel snap, black molded polypropylene bottom, rope handle.

5103S - \$50.99

KLEIN TOOLS HEAVY-DUTY TAPERED WALL CANVAS BUCKET WITH 4 POCKETS

12" height, 12" top diameter, 9" bottom diameter, (4) outside pockets, black molded polypropylene bottom, rope handle, equipped with Cat. No. 2012 swivel snap hook.

5171PS - \$66.99



ARSENAL SYNTHETIC PLASTIC BOTTOM NYLON BUCKET WITH D-RINGS

17" height, 12.5" diameter, interior pocket, load rated 100 lbs.

5653 - \$67.99

5653T With detachable top - \$75.95



ARSENAL SYNTHETIC LEATHER BOTTOM NYLON BUCKET WITH D-RINGS

12.5" height, 10" diameter, inside pocket, load rated 150 lbs.

5650 - \$91.99

5650T With detachable top - \$106.99



ARSENAL SYNTHETIC LEATHER BOTTOM CANVAS BUCKET WITH D-RINGS

17" height, 12.5" diameter, inside pocket, load rated 150 lbs.

5960 - \$76.99

5960T With detachable top - \$96.99



ARSENAL WEB HANDLE CANVAS HOIST BUCKET

17" height, 12.5" diameter, inside pocket, load rated 150 lbs.

5930 - \$85.99

5930T With detachable top - \$108.95



Swivel



Canvas detachable top



Nylon detachable top



ARSENAL PLASTIC BOTTOM CANVAS BUCKET

15" height, 12.5" diameter, inside pocket, load rated 100 lbs.

5733 - \$52.99

5733T With detachable top - \$70.99

5743 With swivel - \$60.99

5743T With detachable top & swivel - \$78.99



ARSENAL LARGE PLASTIC BOTTOM BUCKET

15" height, 12.5" diameter, inside pocket, swivel, load rated 100 lbs.

5743 - \$60.99

5743T With detachable top - \$78.99



ARSENAL LEATHER BOTTOM BUCKET

17" height, 12.5" diameter, inside pocket, swivel, load rated 150 lbs.

5730 - \$85.99

5730T With detachable top - \$99.99



ARSENAL XL LEATHER BOTTOM BUCKET

20" height, 16" diameter, inside pocket, swivel, load rated 150 lbs.

5735 - \$110.99

5735T With detachable top - \$126.99



Fall Protection



DBI SALA 100 LBS LOAD RATED HOOK & LOOP CANVAS BUCKET

Heavy-duty 24 oz cotton duck canvas, puncture resistant plated base, 6 built in connection points, carabiner and hoist strap, hook and loop closure system, and load rated 100 lbs.

1500134 - \$99.99



DBI SALA 100 LBS LOAD RATED DRAWSTRING CANVAS BUCKET

Puncture resistant plated base, carabiner and hoist strap, drawstring closure system, (6) built in connection points, 24 oz cotton duck canvas, and load rated 100 lbs.

1500133 - \$99.99



DBI SALA 250 LBS LOAD RATED HOOK & LOOP VINYL BUCKET

Puncture resistant plated base, carabiner and hoist strap, hook and loop closure system, (6) built in connection points, and load rated 250 lbs.

1500140 - \$99.99



DBI SALA 250 LBS LOAD RATED DRAWSTRING VINYL BUCKET

Puncture resistant plated base, 6 built in connection points, carabiner and hoist strap, drawstring closure system, and load rated 250 lbs.

1500139 - \$99.99



ELK RIVER CANVAS BUCKET

15" height, 12" diameter, 6" x 6" inside pocket, brass snaphook, made from heavy duty canvas for long wear and use, polymer resin bottom, strong UV and rot resistant rope handle.

84403 - \$55.99



PMI GRUNT BUCKET

15" height, 12" diameter, clic-clac pocket closure system, rigid carrying handle, watertight pocket, reinforced base, and load rated 200 lbs.

RB44062 - \$134.95



DBI SALA 100 LBS LOAD RATED CANVAS BUCKET

Puncture resistant plated base, carabiner and hoist strap, hook and loop closure system, 24 oz cotton duck canvas, fits a standard plastic 5 gallon bucket, and load rated 100 lbs.

1500135 - \$130.99

NEW

SEE TOOL LANYARDS
ON PAGE 179

CUSTOMER
CHOICE

VIDEO

MADE IN
USA



GME SUPPLY TOP-CLOSING BOLT BAG WITH CONNECTION POINTS

12" height, 9" length, 5" width, bull-pin loops, durable Cordura 3" drawstring closing top, D-ring connection points, tunnel loop belt connection, exclusive GME Supply logo.

- GM-5416TCPD 12" height - \$32.99
- GM-5516TCPD 18" height - \$39.99

GME SUPPLY HEAVY DUTY TOP-CLOSING BOLT BAG

12" height, 9" length, 5" width, bull-pin loop on each side, durable Cordura 3" drawstring closing top prevents items from falling out, inside pocket, tunnel loop belt connection, up to 3" wide belt capacity, exclusive GME Supply logo.

- GM-5416TCP - \$28.99
- GM-5416TC Without inside pocket - \$24.99



KLEIN TOOLS TOP-CLOSING BOLT BAG

12" height, 9" length, 5" width, bull-pin loop on each side, 3" drawstring closing top, inside pocket, loop belt connection.

- 5416TCP - \$29.99
- 5416TC Without inside pocket - \$28.99



KLEIN TOOLS TOP-CLOSING BOLT BAG

9" height, 5" length, bull-pin loop on each side, 4 connection points inside, 2 on front, belt loop connection.

- 5416OCTO - \$28.99



ELK RIVER DEEP BOLT BAG WITH DRAWSTRING

2.5" width, 10" height, 14" length, drawstring closing top, inside pocket, bull-pin loop on each side, tunnel loop belt connection.

- 84522 - \$37.99



ELK RIVER BOLT BAG WITH DRAWSTRING

2.5" width, 9" height, 10" length, drawstring closing top, bull-pin loops, tunnel loop belt connection.

- 84521 - \$39.99
- 84520 Without top-closing - \$26.99



ELK RIVER DRAWSTRING BOLT BAG

13" length, 10" height, sewn and riveted for increased durability, heavy duty webbing on bottom, exterior front sleeve and interior pocket, (2) tool ring connections.

- 84523 - \$49.99

**TRAP DOOR
PREVENTS
DROPPED OBJECTS**



ARSENAL TOPPED PARTS POUCH

7.5" length x 7.5" width x 12" height; hands-free, self-closing trap door closure that prevents small parts, hardware, and tools from falling when working at-heights; 20 oz water resistant canvas; trap door closure for safety and security; patented nickel plated storm drain; (2) exterior nickel plated D-rings for tool lanyard attachment; (2) exterior tool loops; maximum safe working capacity: 20 lbs.

5528 - \$28.99

PETZL TOOLBAG TOOL POUCH

Constructed of durable material with a drawstring top closure for safety and security, water resistant, attaches to any type of harness.

S47YS 2.5 liters, 6.75" height - \$29.95

S47YL 5 liters, 11" height - \$39.95



**ARSENAL
TOP-CLOSING
BOLT BAG**

10" length, 9" height, cinch-up top, (2) exterior tool loops, storm drain, tunnel loop belt connection.

5725 9" height - \$28.99

5728 13" height - \$30.99



**ARSENAL
TOP PARTS
TARAPAU LIN
POUCH**

7.5" length x 7.5" width x 12" height, waterproof, trap door, storm drain, (2) D-rings for tool lanyards, (2) exterior tool loops.

5538 - \$28.99



**DBI SALA EXTRA
DEEP SMALL
PARTS POUCH**

3" width, 11" height, self-closure system, made from 18 oz duck canvas, extra deep design provides additional pouch space, can be used from a belt or harness.

1500123 - \$52.99



**DBI SALA EXTRA DEEP
TOOL POUCH WITH
D-RING & RETRACTORS**

8.75" width, 13" height, (2) retractors and (1) D-ring; made of heavy duty canvas with inner lining; multiple inner pockets; magnetic strip closure system with side release buckle.

1500128 - \$79.95



**DBI SALA SMALL
PARTS POUCH**

8" width, 10" height; innovative self-closure system that traps objects inside; nearly impossible for object to fall out; easy to retrieve objects since no opening or closing is necessary; compatible with most tool belts.

1500122 - \$59.95



CUSTOMER CHOICE

VIDEO

MADE IN USA

MADE IN USA

GME SUPPLY LARGE UTILITY BAG

8" x 3" top diameter, inside pocket, leather reinforced bottom, ventilation eyelet in bottom, snap belt connection.

GM-5142P 9" length, 10" width - \$27.99

GM-5141P 10" length, 12" width - \$30.99



GME SUPPLY BULL-PIN & BOLT BAG

10" depth, 5" length, 9" width, bull-pin loop on each side, tunnel loop belt connection, heavy-duty construction, up to 3" belt capacity, exclusive GME flame logo.

GM-5416T - \$13.99



VIDEO

KLEIN TOOLS FLAME-RETARDANT BOLT BAG

9" height, 5" length, made of flame-resistant No. 4 canvas, 3" tunnel loop for belt loop connection.

5416TFR - \$22.99

5471FR FR Electrode - \$24.70



KLEIN TOOLS NUT & BOLT POUCH

Interior pocket; top sides of pouch reinforced with leather; inside bottom reinforced with leather and ventilating eyelet; metal snaps on loops for easy attachment; top edge reinforced with 1/4" rope.

51A - \$27.99



KLEIN TOOLS BULL-PIN & BOLT BAG

10" depth, 5" length, 9" width, bull-pin loop on each side, loop belt connection.

5416 - \$16.99

5416T - \$18.99

5416L Leather version - \$49.99



KLEIN TOOLS UTILITY BAG

9" length, 10" width, 8" x 3" top diameter, ventilating eyelet in bottom, snap belt connection.

5142 - \$30.99

5142P With inside pocket - \$32.99



KLEIN TOOLS EXTRA LARGE UTILITY BAG

10" length, 12" width, 5" depth, 9" x 5" top diameter, inside pocket, leather reinforced bottom, ventilation eyelet in bottom, snap belt connection.

5141P - \$32.99



PELICAN PROTECTOR 1500 MEDIUM CASE

Watertight, crushproof, dustproof; easy open double throw latches, open cell core with solid wall design; strong and light weight; O-ring seal; automatic pressure equalization valve; comfortable rubber over-molded handle; stainless steel hardware and padlock protectors; available with and without foam insert. Interior: 16.75" x 11.18" x 6.12". Exterior: 18.5" x 14.06" x 6.93"

1500 - \$199.99



PELICAN PROTECTOR 1520 MEDIUM CASE

Slightly larger than the 1500. Watertight, crushproof, dustproof; easy open double throw latches, open cell core with solid wall design; strong and light weight; O-ring seal; automatic pressure equalization valve; comfortable rubber over-molded handle; stainless steel hardware and padlock protectors; available with and without foam insert. Interior: 18.06" x 12.89" x 6.72". Exterior: 19.78" x 15.77" x 7.41".

1520 - \$214.99



PELICAN PROTECTOR 1510 CARRY-ON CASE

Meets FAA maximum carry on size requirements; retractable extension handle; strong polyurethane wheels with stainless steel bearings; watertight, crushproof, dustproof; easy open double throw latches, open cell core with solid wall design; strong and light weight; O-ring seal; automatic pressure equalization valve; comfortable rubber over-molded handle; stainless steel hardware and padlock protectors; available with and without foam insert. Interior: 19.75" x 11.00" x 7.60". Exterior: 22.00" x 13.81" x 9.00".

1510 - \$279.99



PELICAN PROTECTOR 1620 LARGE CASE

Watertight, crushproof, dustproof; easy open double throw latches, open cell core with solid wall design; strong and light weight; O-ring seal; automatic pressure equalization valve; comfortable rubber over-molded handle; stainless steel hardware and padlock protectors; retractable extension handle; strong polyurethane wheels with stainless steel bearings; fold down side handles; available with and without foam insert. Interior: 21.48" x 16.42" x 12.54". Exterior: 24.76" x 19.57" x 13.90".

1620 - \$409.99



PELICAN PROTECTOR 1400 SMALL CASE

Waterproof, crushproof, and dustproof; comfortable rubber over-molded handle; stainless steel hardware and padlock protectors; easy open double throw latches; open cell core with solid wall design; O-ring seal; automatic pressure equalization valve balances interior pressure and keeps water out; available with and without foam insert. Interior: 11.81" x 8.87" x 5.18". Exterior: 13.37" x 11.62" x 6.00".

1400 - \$129.99



PELICAN PROTECTOR 1550 MEDIUM CASE

Watertight, crushproof, and dustproof; stainless steel hardware and padlock protectors; easy open double throw latches; open cell core with solid wall design, O-ring seal; automatic pressure equalizer valve balances interior pressure and keeps water out; comfortable rubber over-molded handle; available with and without foam insert. Interior: 18.63" x 14.18" x 7.72". Exterior: 20.66" x 17.20" x 8.40".

1550 - \$239.99



ARSENAL DUFFEL BAG

29" x 13" x 13", 600 D polyester with PVC backing, heavy duty ribbed straps top and side, heavy duty #8 zippers, removable adjustable shoulder strap and strap grabber, (2) end zipper pockets. Available in black and red.

5020MP - \$24.99



ARSENAL GENERAL DUTY GEAR BAG

18" x 10" x 12", 600 D polyester main material, 1,680 D ballistic polyester base, heavy duty, PP webbing for structure and durability, water repellent backing on main material.

5116 18"x 10"x 12" - \$47.99

5115 14"x 9"x 10" - \$40.99



KLEIN TOOLS EXTRA-LARGE GEAR BAG

18" depth, 24" length, 10" width, orange vinyl-coated nylon fabric bag, bottom reinforced with 1/4" (6 mm) plywood, nylon-web handles extend around bag for extra support, wide-opening steel frame is securely riveted in top of bag, extra flap for storm protection.

5180 - \$116.99



FOX OUTDOOR JUMBO GEAR BAG / BACKPACK

35" x 13" x 14", rugged tactical polyester, (4) interior mesh pockets, concealed shoulder straps, (2) end pockets with fitted storm flaps and zippered closure, army digital.

54-697 - \$64.29

54-690 Olive Drab - \$64.29

54-691 Black - \$64.29



PMI RIGGERS BAG

24" length, 11" width, 12" height, jumbo main compartment, (6) zippered compartments, 1,000 D heavy coated Cordura, detachable shoulder strap, padded handles, clear ID holder.

RB44031 - \$96.00



FOX OUTDOOR IDF TACTICAL BAG

34" x 15" x 12", replica of Israeli Defense Forces Tactical Bag, (3) zippered outside pockets, (3) end pockets with velcro closure, vinyl waterproof bottom.

41-58 - \$48.79



GME SUPPLY DELUXE GEAR BAG

29" x 17" x 16", huge 4.5 cubic ft interior storage, (4) outside pockets, 600 D, PU coated, polyester duck fabric; back panel opens to reveal a mesh vent window, reflective trim along straps, clear business card holder, shoulder straps.

3025 Red - \$59.99

3050 Black - \$59.99

CUSTOMIZE WITH YOUR LOGO }



**ARSENAL
LARGE F & R
GEAR BAG**

16" x 21" x 15", 1,000 D nylon, double-coated polyurethane, Maltese cross, heavy duty #10 zippers, 2" webbing handle and shoulder straps, Grab 'n Go pull strap and removable shoulder strap.

5005 - \$66.99



**KLEIN TOOLS
VINYL EQUIPMENT
BAG**

24" x 20" x 10", large outside pocket with velcro fastening, adjustable/padded shoulder strap, double-stitched plastic bottom, rain flap, (2) heavy-duty, slide-action buckles; wide-opening, steel frame securely riveted to top of bag helps maintain bag's shape.

5181ORA - \$101.99

5182BLA Black- \$112.69



**ARSENAL WATER
RESISTANT
DUFFEL**

32" x 19" x 19", water resistant tarpaulin material with 1,000D polyester mesh, shoulder straps configured to carry as duffel or backpack, open design for maximum storage capacity, interior mesh pocket under flap, (4) compression straps and (2) haul handles, ID and document pockets on top of bag.

5030L 32" x 19" x 19" - \$124.99

5030M 28" x 17" x 17" - \$103.99

5030S 24" x 15" x 15" - \$92.99



**ARSENAL MOBILE
OFFICE BACKPACK**

14" x 8" x 20"; 1200 D ballistic polyester with water resistant backing; four main compartments including reinforced computer sleeve; two vertical side pockets with storm drain ventilation; crush proof top container; personal items pocket with headphones port; padded shoulder straps for increased comfort under heavy weight; cushioned back padding with airflow design for ventilation; YKK zippers.

5144 - \$191.95



**KLEIN TOOLS
TRADESMAN PRO
HIGH VISIBILITY
BACKPACK**

7" x 20" x 14-3/8"; 39 pockets for extreme tool storage; reflective shoulder straps with extra padding and handle; exterior tape thong and tape measure holder; fully-molded bottom protects from the elements.

55597 - \$146.99



NEW

**KLEIN TOOLS
TRADESMAN
PRO EXTREME
BAG**

17.5" x 14" x 10"; 78 pockets for extreme tool storage; lock bars keep bag propped open; hard molded pocket protects tools, meters and tech devices; wide center with removable pockets for easy access to tools; fully molded bottom protects from the elements; 1,680 D ballistic weave for durability.

5541718-14 - \$170.99



**KLEIN TOOLS
PRO ORGANIZER
BACKPACK**

39 pockets for tool storage, hard molded front pocket protects safety glasses, front zipper pocket for small parts and tools, taller bag and interior pockets allow for long screwdrivers, fully molded bottom protects from elements, orange interior for easy tool visibility, 1,680 D ballistic weave for durability; shoulder straps with extra padding and handles for easy carrying.

55421BP14 - \$96.99

55421BP14CAMO Camo - \$99.99



**ARSENAL
LARGE WHEELED
GEAR BAG**

30" x 14" x 14", 600 D polyester main material, 1680 D polyester base, molded wheels for safe and easy transport, (3) removable internal dividers for organization, molded retractable pull handle, padded and adjustable shoulder strap, heavy-gauge nylon stitching and heavy-duty zippers, material backing provides water protection.

5120 - \$122.99



**CUSTOMER
CHOICE**



CUSTOMER CHOICE VIDEO

PETZL VERTEX VENT

Ventilation holes with adjustable sliding shutters allow air to circulate in the helmet when needed, 6-point webbing suspension system conforms to the shape of the head for improved comfort, shock absorption is achieved through deformation of the outer shell, CenterFit adjustment system ensures centering and optimal stability, ANSI compliant.

- A10VWA White - \$114.95
- A10VRA Red - \$114.95
- A10VOA Orange - \$114.95
- A10VYA Yellow - \$114.95
- A10VYA Hi-Vis - \$114.95
- A10VBA Blue - \$114.95
- A10VNA Black - \$114.95



PETZL VERTEX BEST

Unventilated shell ensures protection against electrical risks and molten metal splash, 6-point webbing suspension system conforms to the shape of the head, CenterFit adjustment system ensures centering and optimal stability, ANSI compliant. Available in white, red, orange, yellow, blue, and black.

A10B - \$114.95



PETZL ALVEO BEST

Unventilated shell ensures protection against electrical risks and molten metal splash, lightweight helmet with comfort foam that is barely felt on the head, shock is absorbed by deformation of the expanded polystyrene liner, CenterFit adjustment system ensures centering and optimal stability, ANSI compliant.

A20B - \$114.95



VIDEO

PETZL ALVEO VENT

Lightweight helmet with comfort foam that is barely felt on the head, shock is absorbed by deformation of the expanded polystyrene liner, CenterFit adjustment system ensures centering and optimal stability, ventilation holes, side slots for mounting hearing protection, inserts for accepting a VIZIR face shield, (4) clips for mounting a headlamp with an elastic headband, (2) thicknesses of foam bands for customized fit, ANSI compliant.

- A20VWA White - \$114.95
- A20VRA Red - \$114.95
- A20VYA Yellow - \$114.95



PETZL VIZEN FACE SHIELD

Easy to mount on Vertex and Alveo helmets, ultra-wrap shield completely protects face against dangers of an electric arc, (2) positions: raised on top of helmet, lowered in working position, scratch / fog resistant, ANSI compliant.

A14 - \$69.95



PETZL VIZIR FACE SHIELD

Easy to mount on Vertex and Alveo helmets, (2) positions: raised on top of helmet, lowered in working position, scratch / fog resistant, ANSI compliant.

- A15A Vizir clear - \$56.95
- A15AS Vizir shadow tinted - \$61.95



PETZL ABSORBENT FOAM

Comfort foam absorbs perspiration and is machine washable.

- A10200 Vertex - \$11.95
- A20200 Alveo - \$11.95



PETZL REPLACEMENT FOAM

Regular foam for most head sizes and thick foam for smaller head sizes, easy maintenance.

- A10210 Vertex - \$8.95
- A20210 Alveo - \$8.95



PETZL REFLECTIVE STICKERS

(4) pre-cut reflective stickers for increased visibility.

- A10110 Vertex - \$11.95
- A20110 Alveo - \$11.95

KASH
helmets

KASK BA HELMET

High density ABS plastic outer shell, HD polystyrene inner shell, PA soft nylon headband, electric shocks protection, earmuffs fitting, removable front pad, Fast3Dry fabric for quick absorption of moisture, ANSI compliant. Available in white, red, yellow, and blue.

WHE00022-204 Red - \$94.95



KASK ZENITH COMBO HELMET

High density ABS plastic outer shell, HD polystyrene inner shell, PA soft nylon headband, electric shocks protection, ring to hook, provided zen visor attachment, luminescent clips, reflective stickers, earmuffs fitting, removable front pad, Fast3Dry fabric for quick absorption of moisture, ANSI compliant. Available in white, black, orange, hi-viz yellow, and hi-viz lime.

WHE00026-210 Black - \$284.95



KASK ZENITH HELMET

High density ABS plastic outer shell, Polystyrene inner shell, PA soft nylon headband, external lamp clips, Fast3Dry fabric for quick absorption of moisture, ANSI compliant. Available in white, red, orange, pink, yellow, blue, black, hi-viz white, hi-viz yellow, hi-viz lime (hi-viz +\$10.00). Limited quantities available in pink.

WHE00031-201 Blue - \$129.95



KASK SUPERPLASMA HELMET

High density ABS Plastic outer shell, Polystyrene inner shell, (10) vents for maximum airflow, high-tech fabric 2DRY for quick absorption of moisture, removable and washable padding, fully adjustable width and height, anti-intrusion grill prevents entry of debris, ANSI compliant. Available in white, red, orange, yellow, blue, black, and hi-viz lime (+\$10.00).

WHE00010 - \$129.99



KASK ZENITH ZEN VISOR

Made from polycarbonate material, scratch / fog resistant panoramic lens, cut proof edge, rubber drip proof upper contour, ANSI rated.

WVI00007-015 Clear - \$38.99

WVI00007-009 Smoke - \$45.99

WVI00007-055 Silver mirror - \$55.99



KASK SUPERPLASMA V2 VISOR

Made from polycarbonate material, scratch / fog resistant panoramic lens, cut proof edge, rubber drip proof upper contour, ANSI rated.

WVI00002-015 Clear - \$38.99

WVI00002-009 Smoke - \$42.99

WVI00002-055 Silver mirror - \$49.99



KASK ADAPTER SET FOR ZENITH VISORS

Installed directly onto Zenith helmets so that Zen Visors can be attached. This set is required for installing visor.

WAC00009 - \$24.95



KASK SILVER REFLECTIVE STICKERS

Pre-cut reflective stickers for better visibility.

WAC00001 Superplasma - \$19.99

WAC00014 Zenith - \$26.99



KASK INNER PADDING

Replacement padding for helmets. Sweatband and inner crown pieces attach directly to helmet.

WPA00003 Superplasma - \$19.99

WPA00006-000 Zenith - \$24.99



JSP DELUXE WHEEL RATCHET HARD HAT

High-density polyethylene shell, 6-point textile cradle suspension, 3D precision fitting, Revolution wheel ratchet adjustment, Chamlon sweatband with Egyptian cotton core and porous PU coating for maximum sweat absorption, universal accessory slots, chin strap, firmest fit available, short brim, ANSI compliant. Available in white, red, yellow, orange, and blue - vented or non-vented.

TW6151 - \$49.99



JSP DELUXE WHEEL RATCHET FULL BRIM HARD HAT

High-density polyethylene shell, 6-point textile cradle suspension, 3D precision fitting, Revolution wheel ratchet adjustment, Chamlon sweatband, provides extra protection to neck and ears, non-vented, ANSI compliant.

EV6161 - \$18.99



JSP MK8 EVOLUTION TYPE II HARD HAT

Side impact and penetration protection, Polystyrene impact liner, high-density polyethylene shell, strap suspension with micro fiber crown pad, wheel ratchet adjustment, ANSI compliant.

AHS150-10 - \$49.99

AHS240-10 With 4-point chin strap - \$59.99



JSP EVOLITE SKYWORKER HARD HAT

Strong ABS plastic shell, shock absorbing 6-point suspension with adjustable polyester straps, unique 3D adjustment for precise fit, side and rear ventilation, 4-point chin strap, sweatband, ANSI compliant.

AJS260 - \$61.94



JSP COMFORT PLUS TYPE I HARD HAT

High-density polyethylene shell, shock absorbing 6-point suspension with adjustable polyester straps, swiveling ratchet suspension, universal accessory slots, brushed nylon backed foam sweatband, ANSI compliant. Available in white, red, orange, yellow, blue, and green.

ML5151-10 - \$9.95



JSP RETRACTABLE SAFETY GLASSES

Clear polycarbonate 6-base curved lens, can be fully retracted into helmet shell, anti-fog and scratch resistant coatings, compatible with any JSP Deluxe 6100 helmet.

250-EVS-0000 - \$9.99



JSP REFLECTIVE STICKERS

This sticker kit gives full brim hard hats 360° reflective coverage. (7) pre-cut stickers.

281-CR2FB-10 Full brim - \$38.99

281-CR2-10 Cap style - \$45.99



JSP DELUXE 2-POINT CHIN STRAP

Helps keep hats and caps stable on the worker's head, attaches directly to shell, 2-point elastic with chin cup, great for work at-height.

281-CSD-2PT - \$5.19



MSA V-GARD FRAME FOR SLOTTED CAPS

Sloped design allows liquids, chips, and other materials to slide off frame and away from sight, ANSI compliant.

10115730 - \$10.99

10117750 Polycarbonate visor - \$5.99



MSA FAS-TRAC REPLACEMENT SUSPENSION

Ratcheting suspension liner includes headband, nape strap, sweatband, and crown straps; Designed for the V-Gard hat or cap shell.

10148708 - \$12.99

10153385 Suspension for Skullgard - \$16.99

MSA SKULLGARD FULL BRIM HARD HAT

Heavy-duty construction for use in steel mills and other heavy industries where elevated temperatures are common, resin shell with 4-point Fas-Trac ratcheting suspension, fits head sizes 6-8, ANSI compliant.

475407 - \$94.99

475395 Cap style - \$89.99



MSA V-GARD DIGITAL CAMOUFLAGE HARD HAT CAP STYLE

Fas-Trac 4-point suspension includes ratcheting system and perforated vinyl sweatband, polyethylene shell, top impact protection, ANSI compliant.

10103908 - \$31.99

10104254 Full brim - \$32.99



MSA V-GARD FULL BRIM HARD HAT

Fas-Trac 4-point suspension includes ratcheting system and perforated vinyl sweatband, polyethylene shell, top impact protection, ANSI compliant. Available in red, blue, green, yellow, orange, hi-vis orange, and white.

475310 - \$19.99



WESTERN OUTLAW COWBOY HARD HAT

6-point deluxe nylon suspension with adjustable ratchet, wide brim provides more UV protection, ANSI compliant. Available in white, black, and tan.

VCB200 - \$27.99



PMI ADVANTAGE NFPA HELMET

Made of Kevlar, fully adjustable ratchet headband and straps, three point chinstrap, headlamp retainer, goggle mount, clips to attach earmuffs, ANSI compliant. Available in red, orange, lime green, blue, white, and matte black.

HL33012 - \$178.50



MSA V-GARD HARD HAT CAP STYLE

Fas-Trac 4-point suspension includes ratcheting system and perforated vinyl sweatband, polyethylene shell, top impact protection, ANSI compliant. Available in red, blue, green, yellow, orange, hi-vis orange, and white.

475358 - \$11.99



PETZL NAO SELF-ADJUSTING HEADLAMP

Reactive lighting with brightness that adapts instantly to need, due to sensor; maximum brightness of 575 lms; (2) lighting levels, lithium-ion rechargeable battery.

E36AHR 2B - \$184.95



PETZL TACTIKKA HEADLAMP

200 lms of power and versatile lighting: comfortable proximity lighting for close-range work, focused lighting for distance vision when moving around, and red lighting to preserve night vision.

E93ACA - \$29.95



PETZL TIKKA PRO HEADLAMP

Compact; (2) lighting modes: a mode for proximity lighting (20 lms) and a mode for limited movement (100 lms); push-button for easy, quick lighting mode selection.

E93HN - \$34.95



PETZL PIXAX 2 HEADLAMP

Mixed beam, versatile and very durable, may be worn on head, mounted on helmet, or placed on ground; provides constant, stable light, (2) lighting modes.

E78BHB2UL - \$59.95



PETZL PIXAX 3 HEADLAMP

Multi-beam, adapted for close-range work, moving around and long-range vision, may be worn on the head, mounted on the helmet, or placed on the ground.

E78CHB2UL - \$74.95



bouton
OPTICAL
a clear vision of safety

BOUTON SUNBURST

This "sun" collection offers polarized and mirror plus lenses featuring an AR treatment to eliminate reflection, lightweight, full frame design for all day comfort, bayonet temples are rubber co-molded for a secure fit, non-slip rubber nose pads provide a comfortable fit, 8 base curve lens, 99.99% UV protection, black frame, silver mirror lens, anti-scratch, anti-reflective, reduces glare up to 15% more than tinted lenses alone, ANSI compliant.

- 250-47-0004 Black frame, red mirror lens - \$10.49
- 250-47-0005 Black frame, silver mirror lens - \$10.49
- 250-47-0006 Black frame, blue mirror lens - \$10.49
- 250-47-0007 Black frame, gold mirror lens - \$10.49
- 250-47-0020 Black frame, clear lens - \$8.49
- 250-47-0021 Black frame, gray lens - \$8.49
- 250-47-0041 Black frame, polarized gray lens - \$29.99
- 250-47-1008 Black frame, green mirror lens - \$10.49
- 250-47-1042 Brown frame, brown lens - \$8.49

✦ Discounted case packs available for all styles.
Additional lens options available in case packs.



MORE COLORS

CUSTOMER CHOICE VIDEO

BOUTON BLIZZARD
White frame, blue mirror lens, lightweight, anti-fog/anti-scratch, 8 base curve, rubber co-molded bayonet temples for a comfortable fit, ANSI compliant.
250-48-0006 - \$5.99

MORE COLORS

VIDEO

BOLLE SAFETY CONTOUR METAL
High impact 2.2 mm polycarbonate lens, anti-fog/anti-scratch, 8 base curve, 99.99% UVA/UVB light absorption, ANSI compliant.
40050 - \$18.99

MORE COLORS

BOUTON CAPTAIN
Black frame, gray lens, anti-fog/anti-scratch, 9 base curve, bayonet temples with end tips that curve out for ease of placement on face, ANSI compliant.
250-46-0021 - \$4.49

MORE COLORS

VIDEO

BOLLE SAFETY SLAM
High impact 2.3 mm polycarbonate lens, anti-fog/anti-scratch, 11 base curve, 99.99% UVA/UVB light absorption, ANSI compliant.
40081 - \$7.99

MORE COLORS

VIDEO

BOUTON COMMANDER
Gloss black frame, gray lens, anti-fog/anti-scratch, 9.5 base curve, bayonet style temples, adjustable rubber nose pads, ANSI compliant.
250-33-0021 - \$8.29

MORE COLORS

VIDEO

BOLLE SAFETY RUSH
High impact 2.2 mm smoke polycarbonate lens, anti-fog/anti-scratch, 10 base curve, 99.99% UVA/UVB light absorption, ANSI compliant.
40071 - \$7.99

MORE COLORS

BOUTON RADAR
Gray frame, gray lens, anti-fog/anti-scratch, 9 base curve, rubber co-molded bayonet temples for a comfortable fit, ANSI compliant.
250-45-0021 - \$5.49

CUSTOMER CHOICE VIDEO

BOLLE SAFETY HUSTLER
High impact 2.2 mm polycarbonate lens, anti-fog/anti-scratch, 8 base curve, 99.99% UVA/UVB light absorption, ANSI compliant.
40149 - \$14.99

BOUTON ANSER

Black frame, smoke lens, anti-scratch, semi-rimless design provides all day user comfort, sleek and sporty style with wraparound lens protection, bayonet temples with flexible rubber tips for comfortable and secure fit, soft rubber nose pads to keep glasses in place, adjustable neck cord, 9 base curve, 99.9% UV protection, ANSI compliant.

- 250-AN-10110 Black frame, clear lens - \$3.99
- 250-AN-10112 Black frame, gray lens - \$3.99
- 250-AN-10114 Black frame, I/O lens - \$4.19
- 250-AN-10115 Black frame, blue mirror lens - \$4.99
- 250-AN-10118 Black frame, IR Filter 3.0 lens - \$6.99
- 250-AN-10119 Black frame, IR Filter 5.0 lens - \$7.99
- 250-AN-10120 Black frame, amber lens - \$3.99
- 250-AN-10121 Camo frame, brown lens - \$6.99
- 250-AN-10123 Camo frame, gray lens - \$6.99
- 250-AN-10125 Black frame, silver mirror lens - \$4.99



COMPARE TO NEMESIS



250-AN-10110



250-AN-10112



250-AN-10114



250-AN-10119



250-AN-10120



250-AN-10121



250-AN-10123



250-AN-10125

SKULLERZ KVASIR

Polycarbonate lenses with scratch-resistant coating filter 99.9% of harmful UVA, rubber temples, temple accessory slot also improves air flow, ANSI compliant, MIL-PRF-32432 compliant.

53130 - \$13.99

MORE COLORS



SKULLERZ DAGR

Rubber co-injection temples and non-slip nose piece, polycarbonate lenses with scratch-resistant coating filter 99.9% of harmful UVA, ANSI compliant, MIL-PRF-32432 compliant.

52020 - \$12.99

MORE COLORS



SKULLERZ VALKYRIE

Polycarbonate lenses with scratch-resistant coating filter 99.9% of harmful UVA, smooth medium frame design with rubber temple, optional foam gasket insert to reduce debris entry, ANSI compliant, MIL-PRF-32432 compliant.

54092 - \$14.99

MORE COLORS



SKULLERZ ODIN

Rubber co-injection temples and non-slip nose piece, polycarbonate lenses with scratch-resistant coating filter 99.9% of harmful UVA, ANSI compliant, MIL-PRF-32432 compliant.

50030 - \$17.99

MORE COLORS



SKULLERZ NJORD

Polycarbonate lenses with scratch-resistant coating filter 99.9% of harmful UVA, ANSI compliant, MIL-PRF-32432 compliant.

55030 - \$11.99

MORE COLORS



SKULLERZ LOKI

These glasses convert to sealed goggle with interchangeable temples, elastic strap and removable foam gasket, ANSI compliant for both spectacles and goggles, MIL-PRF-32432 compliant.

56030 - \$14.99

MORE COLORS



BOLLE SAFETY SHADOW

High impact 2.0 mm red mirror polycarbonate lens, anti-scratch, 8 base curve, 99.99% UVA/UVB light absorption, ANSI compliant.

40159 - \$17.99

MORE COLORS



MORE COLORS



SKULLERZ THOR

Rubber co-injection temples for a secure fit, polycarbonate lenses with scratch-resistant coating filter 99.9% of harmful UVA, ANSI compliant, MIL-PRF-32432 compliant.

51330 - \$18.99

MORE COLORS & OPTIONS



12
PAIRS

SAFETYGEAR ZENON Z12

Gray polycarbonate lens and temples, anti-scratch/anti-fog, rimless design, molded nose bridge, 9.5 base curve, 99.9% UV protection, ANSI compliant.

250-01-0021 - \$17.69

250-01-0920 Clear lens and temples - \$17.69

MORE COLORS & DIOPTERS



SAFETYGEAR ZENON Z12R READERS

28 mm wide reading magnifier, lightweight, rimless design; rubberized temples, gray rubber co-molded temples, molded nose bridge design, 9.25 base curve, +1.50 Diopter, ANSI compliant.

250-27-0115 - \$2.99

MORE COLORS & DIOPTERS



SAFETYGEAR MAG READERS

30 mm wide curved top reading magnifier, +2.00 diopter, durable nylon frame with extra wide bridge pads and soft temple pads for added comfort, 8 base curve, ANSI compliant.

250-25-0020 - \$4.99



BOUTON SCOUT (VISITOR GLASSES)

Large frame that can be used alone or as an Over-The-Glass style to fit all personal eye wear, polycarbonate uni-lens, molded nose bridge design, indirect vent temples to reduce fogging, 4 base curve, ANSI compliant.

250-99-0900 - \$1.99

MORE COLORS



VIDEO

BOUTON BULLSEYE

Gray lens, lightweight, rimless design, flexible bayonet style temples provide a secure fit, molded nose bridge design to fit the vast majority of users, 9 base curve, anti-scratch/anti-fog coating, ANSI compliant.

250-31-0021 - \$4.99

MORE COLORS



VIDEO

BOUTON RECON

Gradient lens, lightweight, rimless design; rubber co-molded bayonet temples for a comfortable fit, non-slip rubber nose pads, anti-fog lens coating, anti-scratch, 10 base curve, ANSI compliant.

250-32-0031 - \$6.99



BOLLE NITRO

High contour lens with 180 degree distortion free viewing and superior optical quality, ultra-low profile design fits under hard hats, latex-free adjustable pivoting strap, anti-scratch/anti-fog, ANSI compliant.

40095 - \$19.99



**BOUTON 550
SOFTSIDES DIRECT VENT**

Provides protection from chips and flying particles, anti-scratch/anti-fog, direct side ventilation, soft vinyl body, fits over most prescription glasses, elastic headband, 99.9% UV protection, ANSI compliant.

248-5090-400B - \$3.95

MORE COLORS



BOLLE DUO

High impact double polycarbonate lens, anti-fog/anti-scratch, 99.99% UVA/UVB light absorption, 9 base curve, indirect lower vents, fog-free performance, TPR frame, adjustable strap, ANSI compliant.

40097 - \$31.99

MORE COLORS



BOLLE TRACKER

Protection from chemical and mechanical risks, upper and lower protection, removable foam reinforcement with indirect ventilation, removable adjustable strap, side ventilation, anti-scratch/anti-fog, ANSI compliant.

40085 - \$19.99

MORE COLORS



BOLLE ATOM

Extremely comfortable thermoplastic rubber (TPR) frame, overflow chute for liquids, ball-pivot, adjustable strap, fits over prescription glasses, anti-scratch/anti-fog, ANSI compliant.

40092 - \$17.49

MORE COLORS



BOUTON FUSELAGE

Clear lens, anti-scratch/anti-fog, temples and headband snap in/out to easily convert from safety glass to dust goggle, flame resistant soft foam padding, 8 base curve, 99.9% UV protection, ANSI compliant.

250-50-042 - \$8.49



3M N100 DISPOSABLE RESPIRATOR

NIOSH's highest rated filtration efficiency in a disposable respirator N100, CoolFlow valve helps keep wearer cool, comfortable foam face seal, adjustable buckle straps, compatible with a variety of protective eye wear and hearing protection, adjustable nose clip, individually packaged.

8223 N100 - \$9.99

8293 P100 - \$10.99



BOX OF 10

3M N95 DISPOSABLE RESPIRATOR

Used in applications involving metal fumes, carbon filter media reduces exposure to ozone/nuisance level of organic vapors, cake resistant filter media and flame resistant, comfortable foam face seal/fully adjustable straps, CoolFlow valve helps keep wearer cool.

8214 - \$32.99

8577 P95 - \$42.99



3M HALF FACE PIECE 6000 SERIES REUSABLE RESPIRATOR

Offers reliable, convenient respiratory protection when combined with 3M Particulate Filters or Cartridges, compatible and convenient respiratory protection. Available in sizes S-L.

6300 - \$14.99



3M FULL FACE 6000 SERIES RESPIRATOR

Quick and easy cleaning; large lens for wide field of view; silicone face seal for enhanced comfort and durability; air purifying respirator (APR), supplied air (SA) and powered air purifying respirator (PAPR) modes, helps provide respiratory protection against a wide variety of gases and vapors when used with approved cartridges and filters. Available in sizes S-L.

6900 - \$144.99



BOX OF 10

270-2050

N95 CONE RESPIRATOR

95% filtration efficiency against airborne particles, low breathing resistance and a soft inner lining ensure all-day comfort, adjustable outside nosepiece (with inside foam padding), flanged mask edge for better face seal, head straps, (10) masks.

270-2050 With valve (10) masks - \$8.49

270-2000 Without valve, (20) masks - \$9.69



BOX OF 10

270-3050

N95 FLAT FOLDED RESPIRATOR

95% filtration efficiency against airborne particles, flat design to easily fit inside pockets, soft and comfortable, adjustable nosepiece (with inside foam padding), adjustable head strap, (10) masks.

270-3050 With valve (10) masks - \$8.99

270-3000 Without valve, (20) masks - \$10.99

3M RESPIRATOR FILTERS



PART	FILTER TYPE	NIOSH APPROVED FOR	COMPATIBLE WITH	QTY	PRICE
2091	P100	Particulates	6000, 6500, 7500, & FF-400 Series	2	\$6.99
2291	P100	Particulates	6000, 6500, 7500, & FF-400 Series	2	\$7.99
2096	P100 with nuisance level Acid Gas	Particulates	6000, 6500, 7500, & FF-400 Series	2	\$8.99
2296	P100 with nuisance level Acid Gas	Particulates	6000, 6500, 7500, & FF-400 Series	2	\$9.99
2097	P100 with nuisance level Organic Vapor	Particulates	6000, 6500, 7500, & FF-400 Series	2	\$8.99
2297	P100 with nuisance level Organic Vapor	Particulates	6000, 6500, 7500, & FF-400 Series	2	\$9.99
5N11	Prefilter for N95	Non-Oil Particulates	6000, 6500, 7500, & FF-400 Series	10	\$14.99
5P71	Prefilter for P95	Particulates	6000, 6500, 7500, & FF-400 Series	10	\$17.99

3M RESPIRATOR CARTRIDGES

PART	CARTRIDGE TYPE	NIOSH APPROVED FOR	COMPATIBLE WITH	QTY	PRICE
60923	OV/AG/P100/Organic Vapor/Acid Gas/ P100	Certain Organic Vapors, Chlorine, Hydrogen Chloride, and Sulfur Dioxide or Hydrogen Sulfide or Hydrogen Fluoride & Particulates	6000, 6500, 7500, & FF-400 Series	2	\$21.99
60924	AM/MA/P100/Ammonia/Methylamine/P100	Ammonia and Methylamine & Particulates	6000, 6500, 7500, & FF-400 Series	2	\$24.99
60925	FM/OV/P100/Formaldehyde/Organic Vapor/P100	Formaldehyde and Certain Organic Vapors & Particulates	6000, 6500, 7500, & FF-400 Series	2	\$24.99
60926	MG/ V/P100/ Multi-Gas/Vapor/P100	Certain Organic Vapors, Chlorine, Hydrogen Chloride, Chlorine Dioxide, Sulfur Dioxide, Hydrogen Sulfide, Ammonia/Methylamine, Formaldehyde or Hydrogen Fluoride & Particulates	6000, 6500, 7500, & FF-400 Series	2	\$23.99
60926S	HG/P100/Mercury/P100	Mercury Vapor, Chlorine, Sulfur Dioxide & Certain Particulates	6000, 6500, 7500, & FF-400 Series	2	\$32.99



ELECTRONIC EAR MUFF WITH HEADBAND ADJUSTMENT & ACTIVE LISTENING

Active allows you to communicate with your colleagues, hear warning signals and other important information while protected from hazardous noise. The Level Dependent microphones provides perfect directional hearing and the Electronic Protection System limits all sounds to a safe sound level. Ergonomic design, replaceable headband and ear cushions contribute to high comfort and increased wear time. For optimal safety communication radios can be connected via the external sound input as well as MP3 players and other common devices. Includes (2) 1.5 V AA batteries for up to 1000 hours of use, external 3.5 mm sound input for MP3 players, etc; tested and CE approved against European and North American standards.

264-47002 - \$94.99



SECURE 1 PASSIVE EAR MUFF WITH ADJUSTABLE HEADBAND

Slim stirrup design, color coding, soft cushions with Smart "Snap-In" System, smooth size adjustment.

263-41001 NRR 23- \$11.99

263-41002 NRR 26 - \$16.99

263-41003 NRR 28 - \$19.99



HELLBERG ECONOMY HEADBAND EAR MUFF

Very lightweight, smooth and easy size adjustment, single-point attachment in combination with flexible sliders ensures that the pressure and seal is always distributed evenly around the ears, NRR 23.

263-11001 - \$4.59



CAP MOUNTED PASSIVE EAR MUFF

Soft cushions maintains a high level of comfort protection, color coding for easy selection and identification, smooth size adjustment.

263-42001 NRR 22 - \$12.99

263-42002 NRR 24 - \$16.99

263-42003 NRR 27 - \$19.99



KITS SAVE CASH

NEW

GME SUPPLY PPE KIT

Kit includes JSP Comfort Plus Hard Hat, Bouton Zenon Safety Glasses with anti-fog gray lens and black temple, MaxiFlex Ultimate Nitrile Coated Nylon Gloves, Howard Leight SmartFit Reusable Ear plugs.

Upgrades available: MSA V-Gard Full Brim Hard Hat (+\$6.00), JSP MK8 Evolution Hard Hat (+\$36.00), Bouton Bullseye Safety Glasses with blue lens and blue temple (+\$2.25), Bolle Rush Safety Glasses with smoke lens and smoke temple (+\$5.75), MaxiCut Ultra Gloves (+\$7.50), Ergodyne 817 ProFlex Thermal Utility Gloves (+\$18.50), Howard Leight Sperian Leightning L3 Earmuffs (+\$21.60), PIP Active Headband Ear Muff (+\$84.50).

99001 - \$14.99

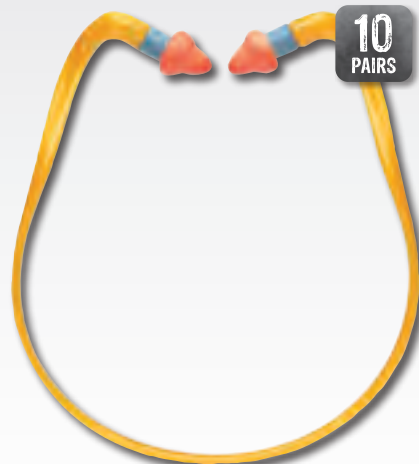

HOWARD LEIGHT INNER-AURAL EAR PLUGS

Smooth, ergonomic pods fit in the ear for maximum protection; patented band design prevents ear pods from touching dirty or contaminated surfaces, lightweight and portable – designed especially for environments with intermittent noise hazards, includes pair of replacement pods. Designed for people who are exposed to intermittent noise, NRR 25.

QB2HYG - \$40.99

QB200HYG Replacement pods - \$5.49



200
PAIRS

**3M E-A-R SOFT FX
UNCORDED EAR PLUGS**

Poly bag keeps each pair of earplugs clean before use. Bell shape allows easy insertion and removal. Noise Reduction Rating: 33 dB.

312-1261 - \$28.99

391-1012 Dispenser bottle - \$67.99



200
PAIRS

**3M NITRO
UNCORDED EAR PLUGS**

Bright-colored, tapered foam design for all day wear with great protection. Includes orange, red, pink and purple assortment. Ultra-soft foam is tapered for easy insertion. Noise Reduction Rating: 32 dB.

P1000 - \$26.99



200
PAIRS

**3M E-A-R TAPERFIT
UNCORDED EAR PLUGS**

Large size TaperFit 2 fits larger ear canals comfortably. Its smooth foam expands in the ear canal to help provide comfortable hearing protection. Poly bag keeps each pair of earplugs available or accessible for re-use. Soft polyurethane foam earplugs. Noise Reduction Rating: 32 dB.

312-1221 - \$30.99



200
PAIRS

**3M E-A-R SOFT FX
CORDED EAR PLUGS**

Soft, pliable foam offers comfort for wearing over an extended time. Bell shape allows easy fitting and removal. Slow recovery foam effectively seals the ear canal and provides reliable hearing protection. Noise Reduction Rating: 33 dB. Poly bag keeps each pair of earplugs clean before use.

312-1260 - \$49.99

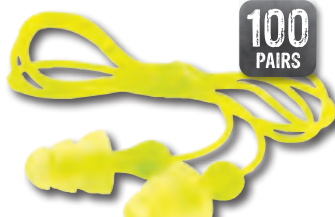

100
PAIRS

**3M TRI-FLANGE
CORDED EAR PLUGS**

Triple-flanged, premolded earplugs fit comfortably in a wide range of ear sizes. Soft, flexible flanges conform to the shape of the ear canal for comfortable noise reduction. Washable and reusable. Noise Reduction Rating: 26 dB. Cord allows earplugs to be stored conveniently around the neck in between uses.

P3000 - \$101.99

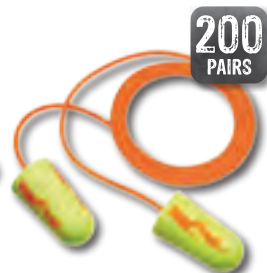

200
PAIRS

**3M E-A-R BLASTS
CORDED EAR PLUGS**

Soft, low-pressure solution with exciting flame graphics. Poly bag keeps each pair of earplugs clean before use. Regular size fits most ear canals. Soft foam earplugs are easy to roll down and insert, then expand within the ear canal for comfortable noise reduction. Noise Reduction Rating: 33 dB.

311-1252 - \$56.99

**3M ONE TOUCH PRO
EAR PLUG DISPENSER**

Dispenser makes it easy for workers to access earplugs. A simple turn of the hand drops earplug into a worker's hand one at a time. Drained catch tray, wind side shields and durable plastic construction safeguards earplugs in outdoor locations. Versatile design allows for placing on countertops or wall mounting. Bulk style dispenser eliminates waste from individually wrapped earplugs. Accepts 8 different 3M Earplugs in refill bottles.

391-0000 - \$78.00



200
PAIRS

**HOWARD LEIGHT MAX
EAR PLUGS**

Single-use, the world's most-used polyurethane foam earplug, bell shaped for maximum in-ear comfort, NRR 33.

MAX-1 - \$25.99

MAX-30 Corded - \$23.49



200
PAIRS

**PIP DISPOSABLE FOAM
EAR PLUGS**

Soft, smooth polyurethane foam expands gradually for a secure comfortable seal; tapered shape offers easy insertion and removal; individually wrapped pairs; NRR 32 dB.

265-200U Uncorded - \$27.99

265-100C Corded - \$25.99



200
PAIRS

**PIP DISPOSABLE FOAM
EAR PLUGS**

Disposable soft polyurethane foam, tapered design fits natural contour of the ear canal, X-Emboss at end of the plug reduces pressure, NRR 30.

267-HPF300 Uncorded - \$21.99

267-HPF300C Corded 100 pairs - \$21.99



200
PAIRS

**PIP DISPOSABLE FOAM
EAR PLUGS**

Disposable soft polyurethane foam, tapered design fits natural contour of the ear canal, X-Emboss at end of the plug reduces pressure, NRR 32.

267-HPF200 Uncorded - \$22.99

267-HPF200C Corded 100 pairs - \$19.99



1416 TILLMAN ECONOMY COWHIDE DRIVER GLOVES

Made from top grain pearl cowhide palm and bourbon cowhide split leather back, unlined, durable and comfortable, these gloves feature a keystone thumb and double stitching to provide extra strength. Available in sizes M-XL.

1416 - \$5.95



1464 TILLMAN WELDING DRIVER GLOVES WITH SPLIT COWHIDE PALMS

Made from top grain cowhide palm with added cowhide split palm, thumb, and index finger; cowhide split back with elastic for snug fit; features Kevlar thread for strength and heat resistance, a rollover index finger for spot welding, and a wing thumb for natural feel. Available in sizes M-XL.

1464 - \$11.99



1454 TILLMAN DRIVERS WITH KEVLAR LINING

Made from long lasting top grain cowhide palm and cowhide split back with elastic for best fit, Kevlar sock lined for added comfort and cut resistance, keystone thumb fits natural shape of hand. Available in sizes S-2XL.

1454 - \$19.95



1452 TILLMAN IMPACT PROTECTION DRIVERS WITH FOAM PADS

Made from long lasting top grain cowhide palm and split cowhide back with elastic below cuff for snug fit, features Kevlar sewn internal foam pads for added heat and impact protection, cotton lined back, unlined palm, and keystone thumb fits natural shape of hand. Available in sizes M-2XL.

1452 - \$12.50

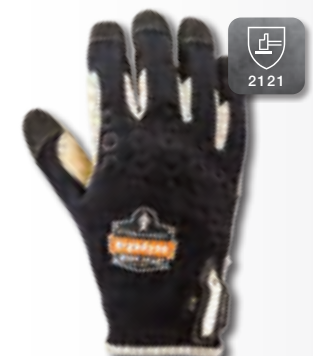

ERGODYNE 710LTR HEAVY-DUTY LEATHER-REINFORCED GLOVES

Made from genuine leather-reinforced palm and fingertips for a natural feel. Features technical hex-stretch knit construction, neoprene knuckle pad, low-profile molded hook and loop closure with ID space, and pull-on tab for easy on/off.

17142 S - \$32.99

17143 M - \$32.99

17144 L - \$32.99

17145 XL - \$32.99

17146 2XL - \$32.99

GLOVE RATINGS 101

Gloves are tested and rated in a few different ways. Next to many gloves you'll see a shield with four numbers. This is the EN388 shield. The EN388 standard is a great measurement of a glove's protection level. Use this guide to determine how your glove of choice stacks up in four important categories.

ABRASION – This is based on the number of cycles required to break down the glove. The protection is rated on a scale of 1 to 4. The higher the number, the better the glove.

CUT RESISTANCE – Based on the number of cycles required to cut through the glove. This scale is rated 1 to 5, with a Cut 5 glove providing the best protection.

TEAR – Rated 1 to 4 with 1 being the easiest to tear, and 4 being the most tear resistant.

PUNCTURE – Based on the amount of force required to pierce the material of the glove. 1 puncture easily, a 4 glove provides the most protection.



3 1 2 1

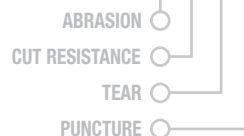

The American National Standards Institute (ANSI) has released a new edition of the ANSI/ISEA 105 Standard (2016 ed.) The changes include new classification levels, which includes a new scale to determine cut score, and a revised method for testing gloves to the standard. Look for the new ANSI Cut Score badge throughout the catalog.

Need help choosing the right hand protection? Give our Gear Experts® a call!



PETZL CORDEX PLUS RIGGING & RAPPELLING GLOVES

Ergonomic cut for high dexterity without being too tight; made of high quality goat skin for perfect balance between durability and dexterity; goat skin leather; carabiner hole to attach gloves to harness. Available in sizes M-2XL.

K53 - \$44.95



MAXIFLEX ULTIMATE BY ATG

Black micro-foam nitrile coated palm and fingertips, 15 gauge gray seamless knit nylon with Lycra liner, breathable coating keeps hands cool and dry, designed to produce minimal lint and dust, minimal penetration, silicone free, excellent dexterity, sensitivity and tactility. Used in applications which require a high degree of dexterity and sensitivity. (12) pairs, available in sizes 2XS-2XL.

34-874 - \$39.99



VIDEO 12 PAIRS 4131

G-TEK NYLON GLOVES WITH POLY GRIP

Seamless knit nylon shell offers increased comfort, finger dexterity and breathability. Polyurethane (PU) coatings offer great puncture and abrasion resistance while offering excellent tactile sensitivity. Breathable back for comfort. (12) pairs, available in sizes S-2XL.

33-GT25 - \$18.00

33-GT125 Touch screen compatible - \$19.00



12 PAIRS 4131

HEXARMOR RIG LIZARD THIN LIZZIE GLOVES

13-gauge high-performance polyethylene and glass fiber blend shell protects hands from cut hazards while allowing maximum dexterity; IR-X Impact Exoskeleton design for protection to back of hand and sandy nitrile palm for exceptional grip; hi-vis color; and washable. Available in sizes S-XL.

2090 - \$25.99



4543 A4

MAXIFLEX ENDURANCE BY ATG

Black micro-foam nitrile, fully coated including ribbed knit wrist, 15 gauge Nylon/Lycra liner. Unique NitrIDot technology on palm for excellent grip. SinAqua repels water and light oil. Actifresh impedes odors and eliminates germs. Designed to produce minimal lint and dust, excellent dexterity, sensitivity and tactility. (12) pairs, available in sizes S-2XL.

34-8745 - \$51.99



12 PAIRS 4131

MAXIDRY BY ATG 3/4 DIPPED

Ultra lightweight nitrile on fine gauge seamless knit nylon liner, 3/4 dipped coating, EN certified 100% low level chemical and oil repellent. Maximum finger tip tactile sensitivity. GripTech coating offers non-slip capabilities, locking cuff, LiquiTech Barrier Technology provides resistance to oils and liquids, silicone free. (12) pairs, available in sizes S-2XL.

56-425 - \$58.99

56-424 Dipped coating on palm and fingertips only - \$54.29



VIDEO 12 PAIRS 4121

MAXIFLEX ELITE BY ATG

Blue micro-foam nitrile coated palm and fingertips, blue seamless knit nylon liner. 30% thinner than traditional foam nitrile gloves. Patented micro-foam nitrile coating offers 360° breathability. Ultra lightweight liner creates smooth and rounded fingertips. Silicone free. (12) pairs, available in sizes XS-2XL.

34-274 - \$39.99



VIDEO 12 PAIRS 4121

MAXIFLEX ACTIVE BY ATG

Designed and developed as a breathable glove. Releases thousands of micro-encapsulated ingredients including aloe vera and vitamin E. MicroFoam Nitrile coatings are compatible with light oils and will provide a good grip and excellent abrasion resistance. 25% thinner than most foam nitrile gloves. 360 breathability, silicon free. (12) pairs, available in sizes XS-2XL.

34-824 - \$41.99



12 PAIRS 4131

SEAMLESS KNIT POLYESTER GLOVE WITH COATED GRIP

Seamless knit nylon shell offers increased comfort, finger dexterity and breathability. PU coatings offer great puncture and abrasion resistance with excellent tactile sensitivity. Breathable back for comfort. (12) pairs, available in sizes S-2XL.

33-G115 - \$8.00

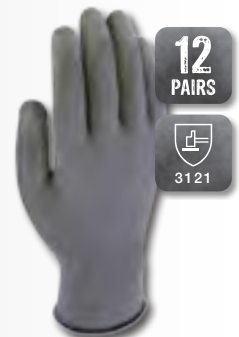

12 PAIRS 3121

PERSONAL SAFETY // HAND PROTECTION



PMI LIGHTWEIGHT RAPPEL GLOVES

Lightweight, pliable goatskin provides excellent finger dexterity while two extra layers of cowhide across the palm maximize protection where you need it most. Available in sizes S-2XL.

GL22004 - \$38.00

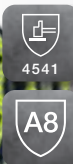

HEXARMOR CHROME SERIES GLOVES

Superior back-of-hand impact protection system utilizes an advanced design to dissipate forceful blows over a large area; durable TP-X palm for exceptional grip; elastic cuff with velcro closure; hi-vis color and reflective tape; and washable. Available in sizes M-XL.

4027 - \$40.99



PMI ROPE TECHNICIAN GLOVES

Synthetic leather (palm base layer), cowhide layer (finger wear points and palm), ergonomically shaped, two-way stretch spandex on top and fingers.

GL22303 M - \$38.00

GL22304 L - \$38.00

GL22305 XL - \$38.00



1414 TILLMAN COWHIDE DRIVER GLOVES

Made from top grain pearl cowhide palm and bourbon cowhide split leather back, durable and comfortable, these gloves feature a keystone thumb, double stitching to provide extra strength, and a rolled leather cuff. Available in sizes M-XL.

1414 - \$9.95



42 TILLMAN PIGSKIN WELDING GLOVES

Premium heavyweight top grain pigskin, great in wet and oily conditions, unlined palm for dexterity, cotton/foam lined back for added heat protection, 4" cuff, straight thumb with added reinforcement strap, lock stitching with Kevlar thread. Available in sizes M-XL.

42M M - \$13.49



K52 PETZL CORDEX BELAY & RAPPEL GLOVES

Lightweight, made from natural, high-quality leather, double layered in high-wear areas, breathable nylon back, neoprene cuff with velcro closure.

K52ST S - \$34.95

K52MT M - \$34.95

K52LT L - \$34.95

K52XLT XL - \$34.95



ERGODYNE 815 QUICKCUFF UTILITY GLOVES

Made from synthetic leather palm with a reinforced thumb saddle wear area. Features breathable poly mesh construction, quickcuff elastic gauntlet fit with ID space, and pull-on tab for easy on/off.

17202 S - \$17.99

17203 M - \$17.99

17204 L - \$17.99

17205 XL - \$17.99

17206 2XL - \$17.99



MAXIMUM SAFETY JOURNEYMAN GLOVES

Brown goatskin leather reinforced palm and back, hi-vis yellow knuckle protectors, split goatskin leather reinforced fingertips, internal foam padded palm, TPR molded knuckle guards, nylon spandex fabric, Sandy PVC thumb crotch and thumb reinforcement, micro cotton thumb, easy-on, easy-off design; hook & loop closure patch. Available in sizes S-2XL.

120-4200 - \$24.95

HEXARMOR RIG LIZARD GLOVES

Synthetic palm with unique stitching pattern offers unrivaled comfort and dexterity; IR-X Impact Exoskeleton protects against forceful blows to the back-of-hand; additional IR-X guard between thumb and index finger; exterior seams implement a double stitched core-spun thread; SlipFit cuff adds comfort and convenience; hi-vis color scheme increases visual awareness; launderable. Available in sizes M-XL.
2021 - \$34.99



HEXARMOR RIG LIZARD ARTIC GLOVES

Dynamic combination of H2X and Thinsulate interior liners for waterproof and cold-resistance; synthetic palm with unique stitching pattern offers unrivaled comfort and dexterity; IR-X Impact Exoskeleton protects against forceful blows to the back-of-hand; additional IR-X guard between thumb and index finger; SlipFit cuff adds comfort and convenience; hi-vis color scheme increases visual awareness; machine washable. Available in sizes M-XL.
2023 - \$43.49



HEXARMOR RIG LIZARD ARTIC GLOVES LEATHER PALMS

Thinsulate interior liner keeps hands warm; waterproof barrier; genuine goatskin leather palm with unique stitching pattern provide industry-leading cut and abrasion resistance; IR-X Impact Exoskeleton protects against forceful blows to the back-of-hand; additional IR-X guard between thumb and index finger; SlipFit cuff with Velcro closure; hi-vis color scheme increases visual awareness XT. Available in sizes M-XL.
2033 - \$53.99



ERGODYNE PROFLEX 710CR GLOVES

Armortex-backed palm for enhanced cut protection; padded palm with Tena-Grip reinforcement; technical hex-stretch poly knit construction; low-profile molded hook and loop closure; pull-on tab for easy on/off.
17122 S - \$41.95
17123 M - \$41.95
17124 L - \$41.95
17125 XL - \$41.95
17126 2XL - \$41.95



PIP G-TEK GP GLOVES

Latex crinkle grip coating palm and fingertips provides superior grip in wet and dry conditions; knit wrist helps prevent dirt and debris from entering the glove; seamless cotton/polyester knit shell is comfortable and flexible. Available in sizes S-XL.
39-1310 - \$15.15



HEXARMOR 2000 SERIES GLOVES

Shell is comprised of a 13-gauge high-performance polyethylene fiber and glass fiber blend; gray polyurethane palm dip increases abrasion resistance and provides exceptional grip; machine washable. Available in sizes M-XL.
2085 - \$12.99

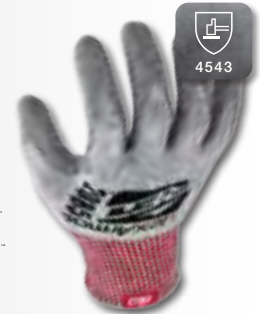

TILLMAN TRUEFIT ULTRA GLOVES

Made from top grain gold/pearl goatskin and nylon spandex; double reinforced finger tips; clute cut design; padding in palm for comfort; elastic cuff for support and protection; hook and loop top wrist closure for adjustability. Available in sizes S-XL.
1490 - \$16.95



TILLMAN TRUEFIT 1470 GLOVES

Made with top grain goatskin, leather, and spandex; reinforced thumb; elastic cuff with hook and loop closure for a secure fit; top grain leather side bolsters. Available in sizes S-XL.
1470 - \$12.25





12
PAIRS

**PIP TOP GRAIN
COWHIDE LEATHER
DRIVER**

Top Grain Cowhide leather construction provides comfort, durability, excellent abrasion resistance, and breathability; features slip-on styling, straight thumb increases comfort in closed-fisted work, elastic closure. (12) pairs, available in sizes XS-2XL.

68-101 - \$78.99



12
PAIRS

**PIP POLYESTER
JERSEY GLOVE**

Cotton/Polyester construction is breathable and decreases hand fatigue, knit wrist helps prevent dirt and debris from entering the glove, clute cut provides a roomy fit, straight thumb increases comfort in closed-fisted work, dark color hides the dirt and extends the wear. (12) pairs, one size fits most.

95-806 - \$4.99

95-806C Women's one size fits most - \$4.99



12
PAIRS

PIP SPLIT COWHIDE

Split Cowhide leather construction provides comfort, durability, excellent abrasion resistance, and breathability; split leather is economical and has a visible texture, features slip-on styling, straight thumb increases comfort in closed-fisted work, elastic closure. (12) pairs, available in sizes S-XL.

69-134 - \$44.99



12
PAIRS

**PIP CANVAS
SINGLE PALM**

Simple and reliable hand protection, multi-purpose fabric gloves, used for light protection in many general applications, natural cotton canvas keeps hands cool and protected, knit wrist helps prevent dirt and debris from entering the glove, clute cut provides roomy fit, straight thumb increases comfort in closed-fisted work. (12) pairs, one size fits most.

90-9081 - \$9.99



12
PAIRS

**PIP SPLIT LEATHER
PALMS WITH SAFETY
CUFFS**

Economy grade cowhide split leather palm glove, wing thumb, and knuckle strap; blue, black, and red striped fabric back; 2.75" rubberized safety cuff with cotton binding, elastic closure sewn inside glove for safety and comfort, cotton lined palm for extra comfort. (12) pairs, available in sizes S-XL.

85-7500 - \$19.99



VIDEO

12
PAIRS

**PIP B/C GRADE SPLIT
LEATHER PALM GLOVE
WITH FABRIC BACK**

Constructed of "B/C" grade shoulder split cowhide, cotton lined palm, gun cut pattern delivers excellent durability, wear, and comfort; wing thumb increases comfort in open-handed work, fabric back provides breathability and flexibility, rubberized safety cuff. (12) pairs, available in Men's XL.

85-7512 - \$24.99



12
PAIRS

4131

**G-TEK TOUCH
SEAMLESS KNIT**

Seamless knit polyester for great dexterity, polyurethane coated palm and fingers for abrasion resistance, breathable back for comfort, static wired thumb, index finger and middle finger allows user to operate touch screen phone or device without removing gloves. Used in construction, sanitation, law enforcement, fire, utilities, electronic and computer assembly, quality control, inspection and general assembly. (12) pairs.

33-GT125 - \$19.99



12
PAIRS

**AMBI-DEX FOOD
GRADE NON-LATEX
POWDER FREE**

Designed for medical and other applications to avoid concerns regarding latex proteins, excellent form-fitting grip, powder free to reduce allergic reactions, ambidextrous for quick and easy donning, food grade, smooth grip. (12) pairs, available in sizes S-XL.

64-346PF - \$54.99

MAXICUT ULTRA BY ATG

High performance yarns and fibres offer cut protection whilst maintaining high levels of comfort, reinforcement between the thumb and forefinger improves cut resistance and extends glove life in an inherently weak area, patented micro-foam nitrile coating offers 360° breathability, mimics the "hand at rest", reducing hand fatigue and increasing comfort; optimized grip delivered through our micro-cup finish, allows for a controlled grip; available in sizes XS-3XL.

44-3445 - \$11.99



MAXIFLEX CUT BY ATG

High performance yarns and fibres offer cut protection whilst maintaining high levels of comfort, reinforcement between the thumb and forefinger improves cut resistance and extends glove life in an inherently weak area, patented micro-foam nitrile coating offers 360° breathability, mimics the "hand at rest", reducing hand fatigue and increasing comfort; optimized grip delivered through our micro-cup finish, allows for a controlled grip; available in sizes XS-2XL.

34-8743 - \$6.49



HEXARMOR CHROME OASIS GLOVES

Advanced HexVent technology allows for a breathable heat-release system; printed PVC synthetic leather palm for exceptional grip; superior back-of-hand impact protection system utilizes an advanced design to dissipate forceful blows over a large area; reinforced index finger and thumb crotch; exterior seams implement a double stitched core-spun thread; hi-vis color.

4030-S S - \$40.49

4030-M M - \$40.49

4030-L L - \$40.49

4030-XL XL \$40.49

4030-XXL 2XL - \$45.99



GREAT WHITE 3GX

Dyneema Diamond and Lycra shell is lightweight and provides excellent dexterity, tactile sensitivity and cut resistance, Seamless construction offers increased comfort and breathability, polyurethane coated palm and fingertips for great abrasion resistance, excellent puncture resistance and outstanding wet/dry grip; available in sizes XS-2XL.

19-D322 - \$7.99

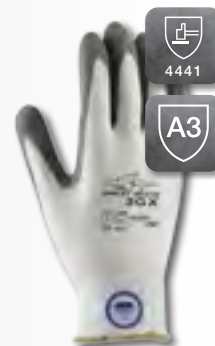

MAXICUT DYNEEMA

Innovative Dyneema engineered high performance yarn and fibers offer cut protection while maintaining high levels of comfort, micro-foam nitrile coatings are compatible with light oils and provide a good grip and excellent abrasion resistance, reinforcement between thumb and forefinger improves cut resistance and extends glove life in wear area, smooth and rounded fingertips improve sensitivity, micro-cup finish allows for controlled grip; available in sizes S-2XL.

19-D470 - \$21.99



G-TEK POLYKOR

High performance polyethylene fiber shell is lightweight and provides excellent dexterity, tactile sensitivity and cut resistance; polyurethane coated palm and fingertips for great abrasion resistance, excellent puncture resistance and outstanding wet/dry grip; washable; resistant to chemicals, water, and ultraviolet light; knit wrists helps prevent dirt and debris from entering glove, available in sizes S-2XL.

16-530 - \$5.75

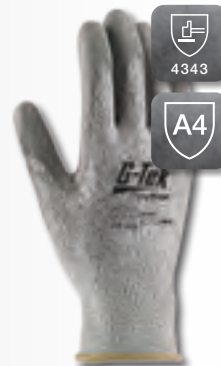

G-TEK KEVLAR

Kevlar and Lycra blend, 15 gauge, lightweight, cut resistant, seamless knit, Polyurethane coated for added abrasion resistance, Kevlar will not melt, ignite or conduct electricity. Dupont Kevlar brand fiber provides high tensile strength relative to its weight - up to five times stronger than steel; available in sizes S-2XL.

09-K1250 - \$3.99



G-TEK 3GX

High performance dyneema and spandex shell is lightweight and provides excellent dexterity, tactile sensitivity and cut resistance, seamless construction offers increased comfort and breathability, polyurethane coated palm and fingertips for great abrasion resistance, excellent puncture resistance and outstanding wet/dry grip, washable, resistant to chemicals, water, and ultraviolet light, knit wrists helps prevent dirt and debris from entering glove; available in sizes XS-2XL.

19-D330 - \$15.99

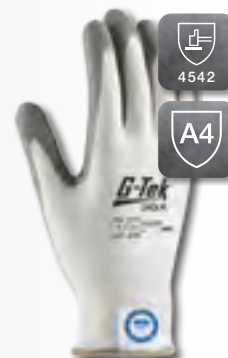

09-K1640



NITRILE FOAM COATING

CUT PROTECTION

TAKES A BOLD LEAP FORWARD



KEVLAR® – A UNIQUE COMBINATION OF HIGH STRENGTH, HIGH MODULUS, & THERMAL STABILITY.

From athletes to astronauts, first responders to industrial workers, Kevlar® enables anyone, with an imagination and a job to do, to Dare Bigger™. PIP, the leading provider of coated seamless knit gloves in America teamed up with DuPont™ to develop the new G-TEK® KEV™ series of cut resistant gloves.

The power of Kevlar® combined with metal core for maximum protection.

CALL (800) 262-5755 TO DARE BIGGER™.



Kevlar.

DARE BIGGER™



PIP'S NEW SERIES OF G-TEK® KEV™ CUT RESISTANT GLOVES

09-K1600



NITRILE FOAM COATING

09-K1630



NITRILE FOAM COATING

09-K1618



NITRILE FOAM COATING

09-K1218



NEOFOAM™ COATING

PROTECTIVE INDUSTRIAL PRODUCTS, INC.

BRINGING THE BEST OF THE WORLD TO YOU®

www.pipusa.com



FIRST AID 101

ANSI has set standards for minimum requirements for first aid kits and their contents. (ANSI Z308.1) These kits are classified by the assortment and quantity of first aid supplies to treat injuries and illnesses common to workplaces, such as major and minor wounds, minor burns, sprains and strains, and eye injuries.

This standard has been updated many times. For more information, give our Gear Experts® a call!

ANSI KIT CLASSES

This standard breaks kits into two classes. Class A and Class B. These are described below.

CLASS A KITS

These kits are designed to deal with the most common types of work place injuries.

CLASS B KITS

These kits are designed with a more varied type and quantity of supplies and are intended to deal with injuries in more complex or high-risk environments.

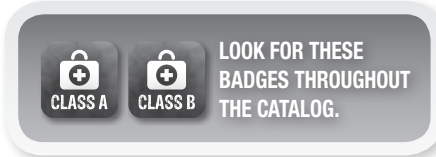

KIT CLASSIFICATIONS

Kit containers are also classified by portability, mounting options, resistance to water, and corrosion and impact resistance.

TYPE 1

Intended for use in stationary, indoor application.

Not intended to be portable and should have means to be mounted in a fixed position.

TYPE 2

Intended for portable, indoor applications. Should be equipped with a carrying handle.

TYPE 3

Intended for portable use in mobile indoor and outdoor settings. Should have means to be mounted and have a water resistant seal.

TYPE 4

Intended for portable use in mobile industries or outdoor applications where the potential for damage due to environmental factors and rough handling is present.



The new standard also specifies that the kits contain first aid supplies in uniform-sized, color-coded boxes as follows:



BLUE:
Antiseptic



YELLOW:
Bandages



RED:
Burn Treatment



ORANGE:
Personal Protective Equipment



GREEN:
Miscellaneous

ANSI Z308.1-2015: CLASSES OF FIRST AID KITS & REQUIRED SUPPLIES

FIRST AID SUPPLY	MINIMUM QUANTITY		MINIMUM SIZE OR VOLUME	
	CLASS A KITS	CLASS B KITS	U.S.	METRIC
Adhesive bandage	16	50	1 x 3 in	2.5 x 7.5 cm
Adhesive tape	1	2	2.5 yd (total)	2.3 m
Antibiotic application	10	25	1/7 oz	0.5 g
Antiseptic	10	50	1/7 oz	0.5 g
Breathing barrier	1	1	N/A	N/A
Burn dressing (gel soaked)	1	2	4 x 4 in	10 x 10 cm
Burn treatment	10	25	1/32 oz	0.9 g
Cold pack	1	2	4 x 5 in	10 x 12.5 cm
Eye covering (with means of attachment)	2	2	2.9 sq in	19 sq cm
Eye/skin wash	1 fl oz total	N/A	N/A	29.6 mL
	N/A	4 fl oz total	N/A	118.3 mL
First aid guide	1	1	N/A	N/A
Hand sanitizer	6	10	1/32 oz	0.9 g
Medical exam gloves	2 pairs	4 pairs	N/A	N/A
Roller bandage (2 in)	1	2	2 in x 4 yd	5 cm x 3.66 m
Roller bandage (4 in)	0	1	4 in x 4 yd	10 cm x 3.66 m
Scissors	1	1	N/A	N/A
Splint	0	1	4.0 x 24 in	10.2 x 61 cm
Sterile pad	2	4	3 x 3 in	7.5 x 7.5 cm
Tourniquet	0	1	1 in (width)	2.5 cm (width)
Trauma pad	2	4	5 x 9 in	12.7 x 22.9 cm
Triangular bandage	1	2	40 x 40 x 56 in	101 x 101 x 142 cm



NORTH MAJOR TRAUMA KIT

Assembled especially for use by those trained in rescue of injured victims, contains all the supplies necessary to treat a variety of wounds and other emergency medical needs. Kit includes adhesive tape, assorted bandages, hand wash, bloodstopper, facial dressing, eye wash, emergency blanket, rescue blanket, forceps, scissors, cold packs, first aid booklet, ABD pads, gauze pads, eye pads, Microshield CPR Mask, splint boards, gloves, wipes, hydrocortisone, all in a rugged nylon bag with carrying straps for easy transport.

148820 - \$220.99



PAC-KIT GME SUPPLY EMS BAG

Emergency kit includes adhesive bandages, emergency blanket, bottle of purified water, bloodborn pathogens and CPR mask, CPR mask with one way valve, body fluid spill clean up pack, small wound dressing pack, topical powder, stretch gauze bandage wrap, gauze pads, instant cold packs, sterile multi trauma dressings, scissors, gloves, burn gel, ammonia inhalants, tape, eye pads, alcohol cleansing pads, triangular bandage, triple antibiotic, pupil gauge, first aid booklet, all in a nylon case with carrying handles.

GMEEMS - \$110.00



PAC-KIT EMERGENCY CPR KIT

Emergency CPR kit includes mask, gloves, antiseptic wipes, emergency blanket and biohazard bag; zip up soft pouch with handles, (11) piece kit, bag size: 7.5" x 7" x 2".

3020 - \$21.95



PAC-KIT FIRST RESPONDER KIT

Durable Flambeau portable case, sold as a (98) piece kit, includes abdominal pads, fabric adhesive strips, assorted bandages, cloth adhesive tape, aluminized rescue blanket, antiseptic wipes, biohazard bags, cold packs, assorted gloves, sterile eye cup, eye wash, eye pads, forceps, trauma dressings, scissors, triple antibiotic ointment packets, water gel burn dressing. Case size: 17.5" x 12" x 13.5".

3100 - \$121.99



PAC-KIT TITANIUM BONDED SHEARS

These 7" shears are perfect for ER and EMS staff, or for use in rescue kits. Titanium bonded blades are able to cut through lanyards or harness webbing in the event of a rescue situation.

90292 - \$7.95



PAC-KIT ALL-TERRAIN FIRST AID KIT

For intense working conditions, contains essential supplies for common injuries on fracking, mining, oil/gas refinery, and power generation/utilities work sites; comes stocked with emergency supplies to combat severe burns, eye injuries, major wounds, snake bites, stings, and other on-site emergencies.

9000 - \$199.99



PAC-KIT EMS TRAUMA KIT

Emergency response trauma kit includes a full assortment of EMS grade first responder supplies, snap cover closure soft bag with organizer compartments inside, roomy but compact, (151) piece kit, bag size: 11.5" x 10.5" x 5".

3500 - \$132.99



PAC-KIT EMERGENCY RESPONSE BACKPACK

Emergency response backpack includes a full assortment of EMT grade first responder supplies, Soft sided zip up backpack with carrying straps, 91 piece kit; kit size: 12" x 16" x 5".

3300 - \$139.99



PIP FIRST AID KIT

Contains the supplies you need to treat minor injuries, plastic box is gasketed for weatherproof protection, convenient molded carry handle includes slots for wall mounting, lightweight kit is ideal for use in the office or vehicle, labels have first aid instructions in English and Spanish, meets ANSI Z308.1-2009 requirements.

299-13210 (10) person kit - \$13.99

299-13225 (25) person kit - \$18.99

299-13255 (50) person kit - \$34.99



PAC-KIT SOFT POUCH FIRST AID KIT

Zip up soft pouch first aid kit; 7.5" x 7" x 3"; contents meet or exceed those required items from ANSI Z308.1-2009; OSHA compliant pouch has easy carry handles or is wall mountable.

7082 (25) person - \$27.99

7088 (50) person - \$48.99



FIRST AID ONLY CLASS A+ BULK FIRST AID KIT

Class A+ Type 3 standard kit, weather resistant plastic case, includes carrying handle and slots for wall mounting, lightweight kit is ideal for use in the office or vehicle, meets ANSI/ISEA Z308.1-2015 requirements, 183 pieces, 9.5" x 10" x 3".

90565 (50) person kit - \$49.99

90617 (50) person refill - \$39.95



PAC-KIT WEATHERPROOF PLASTIC FIRST AID KIT

Weatherproof plastic; contents meet or exceed those required items from ANSI Z308.1-2009; gasket seal keeps contents free of dust and moisture; neat, orderly interior packaging makes contents easy to locate and use; OSHA compliant box has easy carry handle or is wall mountable.

6410 (10) person kit - \$16.99

6430 (25) person kit - \$20.99

6490 (50) person kit - \$29.99



FIRST AID ONLY CLASS B BULK FIRST AID KIT

Class B Type 3 standard kit, weather resistant plastic case, includes carrying handle and slots for wall mounting, lightweight kit is ideal for use in the office or vehicle, meets ANSI/ISEA Z308.1-2015 requirements, 199 pieces, 9.5" x 10" x 3".

90566 (50) person kit - \$79.95

90586 (50) person refill - \$69.95



PAC-KIT WEATHERPROOF VEHICLE FIRST AID KIT

Weatherproof steel, 4.5" x 7.5" x 2.75", contents meet or exceed those required items from ANSI Z308.1-2009; OSHA compliant box has easy carry handle or is wall mountable.

6400 (10) person kit - \$31.49

6420 (25) person kit - \$40.99

6450 (50) person kit - \$49.99



PAC-KIT 3 SHELF FIRST AID STATION REFILL

Completely refills your 3 shelf first aid kit, part number 6155, all contents meet or exceed ANSI Z308.1-2009, includes 493 items, contains supplies for treating traumatic wounds, cuts, abrasions, headaches, and burns.

PK-6155R - \$79.99



PAC-KIT 3 SHELF STEEL FIRST AID STATION

17.5" x 13.5" x 6"; (50) 1" x 3" heavy woven fabric strips; (10) heavy woven extra large strips; (25) heavy woven knuckle bandages; (25) heavy woven fingertip bandages; 12" sterile gauze bandages; 14" sterile gauze bandages; (10) 2" gauze pads; (10) 3" gauze pads; (10) 4" gauze pads; hema-seal trauma dressing; 22" tri-cut adhesive tape; (2) triangular bandages; (100) alcohol antiseptic wipes; (25) antiseptic towelettes; (25) first aid/burn cream packets; (25) triple antibiotic ointment packets; 14 oz eyewash, sterile eye cup, pads, strips; 14 oz burn spray; 14 oz antiseptic spray; (50) extra strength non-aspirin tablets; (100) cotton tip applicators; large instant cold pack; 14" elastic bandages; (100) exam gloves; scissors; forceps; and first aid guide.

6155 - \$158.99



PAC-KIT PHYSICIANS CARE FIRST AID KIT & EYE WASH STATION

Combination eyewash and first aid station, (25) person first aid kit provides essential supplies for most common workplace injuries, 16 oz eyewash for flushing or irrigating the eyes, includes eye cup for easily focusing the fluid stream into affected eye, wall mountable, includes mounting hardware, ANSI and OSHA compliant, FDA approved eyewash.

24-500 - \$43.99



PAC-KIT EYE WASH STATION

Twin bottle eye flush station with wall mount, used for flushing or irrigating the eyes, includes eye cup for easily focusing the fluid stream into affected eye, includes (2) 16 oz bottles of eye wash.

24-102 - \$21.99

24-300 (2) 32 oz bottles of eye wash - \$39.99

24-202 Single station with (1) 32 oz bottle of eye wash - \$19.99



PAC-KIT 16 OZ EYE WASH REFILL

Replacement bottles of sterile isotonic buffered solution for flushing or irrigating the eyes. Also available in cases of 12.

24-101 - \$8.99

24-201 32 oz bottles - \$13.99

**PIP CLEAR
FLAT CAP GEL
KNEE PADS**

Air-injected gel pads are ideal for work on hard surfaces, clear PVC cap features slip-resistant ridges to prevent sliding, flat kneeling surface prevents rocking to minimize fatigue, adjustable hook & loop closure strap.

291-130 - \$10.99



**PIP HARD
PLASTIC CAP
KNEE PADS**

Durable lightweight comfortable pads, abrasion resistant plastic knee cap, thick foam center padding, adjustable hook & loop closure straps.

291-100 - \$4.99



**PIP
NON-MARRING
KNEE PADS**

Ideal for delicate surfaces, extended rubber-like PVC cap won't damage surfaces, ergonomically designed to flex with knee movement, slip-resistant ridges prevent sliding on floors, adjustable hook & loop closure straps.

291-110 - \$8.95



**PROFLEX
350 GEL FOAM
KNEE PADS**

12 mm NBR gel padding and 20 mm EVA padding, hook and loop closure, gel comfort with slip resistant, puncture resistant soft cap.

18350 - \$38.99



**PROFLEX
EXTRA LONG
CAP INJECTED
GEL KNEE PADS**

Patented suspension design redirects pressure away from the patella, 100% Injected Gel and PU foam for long lasting comfort, wide/breathable lycra strap with hook and loop closure, unique fastening system uses calf muscle to eliminate straps behind knee, extended shin protection optimizes stability and comfort, adjusts to any calf size, silicone-free.

342 - \$73.99



**PROFLEX 357
SHORT CAP
LIGHTWEIGHT
GEL KNEE
PADS**

Lightweight gel and EVA foam for mobile comfort, innovative cap shape allows rocking and leaning, bottom webbing and top elastic straps, stitched-in plastic clip adjustment.

18358 - \$28.10



**PROFLEX
LOW-PROFILE
CAP GEL
KNEE PADS**

Gel and EVA foam for lightweight comfort, grooved cap design for added grip, low profile cap prevents rollover, upper and lower elastic straps with hook and loop closure, short cap design for lightweight and mobile protection, silicone-free.

367 - \$32.59



620 PROFLEX KNEE SLEEVE

Knee sleeve with Open Patella/Spiral Stays, contoured design conforms to the body's natural shape, neoprene four-way stretch fabric provides uniform support and warmth, ambidextrous.

16542 S (13-14") - \$22.99

16543 M (14-15") - \$22.99

16544 L (15-16") - \$22.99

16545 XL (16-18") - \$22.99

16546 2XL (18-20") - \$22.99



**PROFLEX
SINGLE STRAP
WRIST SUPPORT**

Limits downward (flexion) wrist movements, patented Open-Center Stay, elastic two-stage hook & loop closure, anti-odor treatment. Available in black or tan, sizes S-XL, left or right handed.

4000 - \$10.99





CHILL-ITS EVAPORATIVE COOLING BANDANA WITH ACTIVATED POLYMERS

Activated polymers bring cooling power where you need it most; activate by soaking in water for 2-5 minutes, re-usable: just soak in water to re-activate, tie closure. Available in lime and solid blue.

6700FR - \$5.99

6700MF Microfiber - \$4.99



CHILL-ITS EVAPORATIVE COOLING BANDANA WITH COOLING TOWEL

Advanced PVA material activates easily and quickly when run under water for one minute, re-usable: just soak to re-activate, tie closure. Available in stars and stripes, red western, navy western, lime, solid blue, camo, flames, and skulls prints.

6700CT - \$3.99



CHILL-ITS EVAPORATIVE COOLING BANDANA WITH COOLING TOWEL

Advanced PVA material activates easily and quickly when run under water for one minute, re-usable: just soak to re-activate, velcro closure. Available in stars and stripes, red western, navy western, lime, solid blue, camo, flames, and skulls prints.

6705CT - \$4.99



CHILL-ITS EVAPORATIVE COOLING TRIANGLE HAT WITH COOLING TOWEL

Advanced PVA material activates easily and quickly when run under water for one minute, re-usable: just soak to re-activate, tie closure. Available in stars and stripes, red western, navy western, lime, solid blue, camo, flames, and skulls prints.

6710CT - \$6.99



CHILL-ITS HIGH PERFORMANCE DEW RAG

Hi Cool moisture management performance fabric transports moisture away, comfortable to wear under hats, helmets or alone; absorbent terry headband, elastic band for a great fit. Available in stars and stripes, red western, navy western, lime, solid blue, camo, flames, and skulls prints.

6615 - \$5.99



CHILL-ITS EVAPORATIVE COOLING BANDANA WITH ACTIVATED POLYMERS

Activated polymers bring cooling power where you need it most; activate by soaking in water for 2-5 minutes, re-usable: just soak in water to re-activate, hook and loop closure. Available in stars and stripes, red western, navy western, lime, solid blue, camo, flames, and skulls prints.

6705 - \$1.99



CHILL-ITS EVAPORATIVE COOLING TOWEL

Dampen this synthetic space age towel to create a cooling aid significantly colder than ambient air, advanced PVA material holds water without feeling heavy, super-evaporative, wear for hours or wipe off for quick relief, simply re-wet the towel to reactivate, machine washable, comes with reusable container for storage. Available in hi-vis lime, orange, gray, blue, and pink.

6602 - \$7.99

6602MF Microfiber - \$8.99

12410 50 pack - \$249.99



CHILL-ITS EVAPORATIVE COOLING BAND

Dampen this synthetic space age towel to create a cooling aid significantly colder than ambient air, advanced PVA cooling technology, super-evaporative, activates fast and easy - run under cold water for one minute, 1/3 the size of the Chill-Its 6602 with the same cooling power, use as a neck wrap by pulling end of wrap through slit, wear for hours or for quick relief, simply re-wet to reactivate, machine washable.

6603 - \$3.29



CHILL-ITS LOW PROFILE HYDRATION PACK

420 D nylon shell stands up to long term wear and tear, zip-up cap cover keeps debris and contaminants at bay, closed cell insulation keeps water cool for hours, TPE polymer bladder for water that tastes like water, not plastic, big mouth opening for simple filling and cleaning, 70 oz (2 liter) capacity.

5155 Black - \$40.99

5155HV Hi-Vis - \$45.99



ERGODYNE 6000 SHAX HEAVY-DUTY COMMERCIAL POP-UP TENT

This tent is perfect for all outdoor activities, both hot and cold. This easy-to-setup tent will protect you from UV rays, or protect you from slightly less than desirable weather. Use it as a hydration station for those hot summer days. Add the optional 6098 Shax Side Panels to protect you from the wind or enclose more warmth during the winter. 10' x 10', peak height of 14', and weighs less than 50 lbs. Made from rugged 300 D polyester shell with PU coating. Double vented top for maximum air flow. Convenient wheel bag for easy storage and transport. ABS plastic sliders for convenient height adjustment. Heavy-duty ground stakes and ropes included. Meets CPAI-84 fire code.

12900 50 lbs - \$302.99

12910 44 lbs - \$196.99

CHILL-ITS WIDE MOUTH WATER BOTTLE

Portable water bottle to keep you hydrated while away from a water source, tough (BPA Free) impact resistant Tritan copolyester plastic, odor resistant with enhanced durability to high heat and humidity, wide mouth to easily fit ice cubes, dishwasher safe. Available in orange, gray, or lime.

5151 - \$9.95



CHILL-ITS EVAPORATIVE HI-VIS RANGER HAT WITH COOLING TOWEL

Wide brim and vented mesh side panels, lined with an advanced PVA material for the ultimate in cooling relief, easily activated by running under water for one minute, cooling sensation lasts for up to (4) hours, ANSI certified 150 D Oxford Polyester, 1" Level 2 ANSI-compliant tape with contrasting color. Available in size S/M or L/XL.

8935CT With cooling towel - \$14.99

8935 Without cooling towel - \$12.99

CHILL-ITS EVAPORATIVE COOLING HARD HAT PAD WITH COOLING TOWEL

Advanced PVA material activates easily and quickly when run under water for one minute, hook and loop closures, conveniently attaches to hard hat suspension headband, reusable, just resoak.

6715CT - \$4.59

6716 Liner - \$3.99

6717CT Pad with neck shade - \$8.69

CHILL-ITS EVAPORATIVE COOLING HARD HAT PAD WITH POLYMERS

Lightweight, cooling acrylic polymers, hook and loop closures, conveniently attaches to hard hat suspension headband, soak in water 2-5 minutes to activate, remains hydrated for up to (4) hours.

6715 - \$2.49

6716 Liner - \$3.99

6717 Pad with neck shade - \$3.79

CHILL-ITS HARD HAT NECK SHADE

Hook and loop allows for easy attachment, quilted nylon outer layer, activated, polymer-embedded fabric inside; water-repellent liner, 100% nylon, remains hydrated for up to 4 hours, soak in water 2-5 minutes to activate. Available in gray or lime.

6670CT - \$12.99



AMBI-DEX FOOD GRADE DISPOSABLE NITRILE GLOVE, 4 MIL

Economical puncture resistance, textured grip, no natural rubber latex proteins, ambidextrous and powdered, 21CFR, 170-199.

63-532 - \$6.49

63-532PF Powder free - \$6.99



AMBI-DEX INDUSTRIAL GRADE DISPOSABLE LATEX GLOVE, 5 MIL

Fully textured, beaded cuff adds strength and prevents liquid run off, ambidextrous and powdered, 21CFR, 170-199, ASTM A-3578.

62-322 - \$6.09

62-322PF Powder free - \$6.49



AMBI-DEX FOOD GRADE DISPOSABLE NON-LATEX GLOVE, 4 MIL

Look, fit, and feel of latex without concern of natural rubber; form-fitting textured grip, ambidextrous and powdered, 21CFR, 170-199.

64-346 - \$4.99

64-346PF Powder free - \$5.49



3M DISPOSABLE PROTECTIVE COVERALL WITH HOOD

Elastic waist, ankles, and wrists for convenience and freedom of movement. Two-way zipper with storm flap for convenience and to help provide additional protection. Anti-static coating on both sides helps reduce static build-up and prevent the risk of static discharge during use. Does not contain components made from natural rubber latex to help prevent reactions from users with latex sensitivities or restrictions. Available in sizes M-4XL.

4510 - \$6.99



3M DISPOSABLE PROTECTIVE COVERALL

Elastic waist, ankles, and wrists for convenience and freedom of movement. Two-way zipper with storm flap for convenience and to help provide additional protection. Anti-static coating on both sides helps reduce static build-up and prevent the risk of static discharge during use. Does not contain components made from natural rubber latex to help prevent reactions from users with latex sensitivities or restrictions. Available in sizes M-4XL.

4510CS - \$5.99



DUPONT TYVEK HOOD

Pullover hood design features elastic face opening for good fit around PAPR, extends over shoulders from provide full head protection, surged seams, one size fits most.

TY657S WH - \$5.99

Case pack (100) - \$89.99



3M DISPOSABLE PROTECTIVE OVERSHOE COVER

Offers a general barrier to non-hazardous substances, anti-static treated, universal size, elasticated ankle fitting. 150 pairs/case.

52562 - \$106.58

NATIONAL SAFETY APPAREL FR MODACRYLIC SWEATSHIRT

Inherently flame resistant; rib knit cuffs; reinforced front pockets; generous sizing for optimal movement; warmth without the weight; drawstring hood to fit over standard hard hat. NFPA and OSHA compliant. Available in sizes S-4XL.
C211G03 - \$107.99



NATIONAL SAFETY APPAREL FR CLASSIC COTTON HENLEY SHIRT

Soft, breathable fabric; convenient left chest pocket; 3-button front placket; rib knit cuff and collar; generous sizing for optimal movement. NFPA and OSHA compliant. Available in sizes S-4XL in khaki, gray, navy, and orange.

- C54PABSLS Khaki - \$68.99**
- C54PGBSLS Gray - \$68.99**
- C54PIBSLS Navy - \$68.99**
- C54PQBSLS Orange - \$68.99**



NATIONAL SAFETY APPAREL FR LEGACY FIELD COAT

Rugged outer shell with a soft, thin liner; heavy duty front zipper; larger hood to fit over standard hard hats; (2) lower front pockets; sporty styling; knit wrist cuffs. NFPA and OSHA compliant. Available in sizes S-3XL.
C55UPUKXLRG - \$152.99



NATIONAL SAFETY APPAREL EXPLORER FR UNLINED BIB OVERALLS

Durable water repellent finish; 26" covered FR zipper closure for easy entry; double bib pockets; (2) back pockets; (2) tool pockets on sides; quick disconnect adjustable buckles at each shoulder strap. NFPA and OSHA compliant. Available in waist sizes 30"40" and inseam sizes 30", 32", and 34".
BIB6DCM Caramel - \$119.99
BIB6DNV Navy - \$119.99



NATIONAL SAFETY APPAREL DRIFIRE PRIME

Inherently flame resistant; lightweight breathable fabric for maximum comfort; athletic design and cut; odor control technology; uses dri-release moisture management technology. NFPA and OSHA compliant. Available in sizes S-3XL.

- DF2-CM-762-PTP Long johns - \$74.99**
- DF2-CM-762-PBB Boxer briefs - \$31.99**



NATIONAL SAFETY APPAREL DRIFIRE PRIME SHIRTS

Inherently flame resistant; lightweight breathable fabric for maximum comfort; athletic design and cut; odor control technology; uses dri-release moisture management technology; tagless collar. NFPA and OSHA compliant. Available in sizes S-3XL.

- DF2-CM-762-PLS Long sleeve - \$72.99**
- DF2-CM-762-PTS Short sleeve - \$37.99**





**TRUEWERK
DOUBLE-STITCH
T1 WERKSHORT**

4-way stretch with stain resistant durable water repellent coating, board-short closure enables a great fit, 7 pockets, thigh and hip stash pockets with riveted corners, gusseted crotch to improve mobility and durability; Available in sizes S-XL

S16-0004 - \$59.00



TRUEWERK G2 WERKPANT

G270 & G300 WerkFabrics feature Cordura nylon blended with cotton for work-level abrasion resistance, stretch mobility and burn/not-melt performance. 10+ pockets including removable trick pockets and knee pad pockets. 3D fit from 2 way stretch, gusseted inseam, and articulated knees. 3M prismatic retro-reflective detailing improves day and night visibility. Available in sizes 30 W x 30 L, 32 W x 32 L, 34 W x 32 L, 36 W x 32 L, 38 W x 32 L, 40 W x 32 L, 32 W x 34 L, 36 W x 30 L, 34 W x 34 L, 34 W x 30 L, 36 W x 34 L.

GV-0001 - \$124.00

**TRUEWERK
EDO WERKPANT**

Engineered for performance for a wide range of applications. Articulated knees and a gusseted inseam ensure full range of motion. Features phone / tool pocket with 3M micro-prismatic reflective material, reinforced back cuffs and front pockets protect high-wear areas. Available in sizes 30 W x 32 L, 32 W x 32 L, 34 W x 32 L, 36 W x 32 L, 38 W x 32 L.

GV-0003 - \$99.00

**TRUEWERK
DOUBLE-STITCH
T3 WERKPANT**

Bonded grid-fleece lining layer for warmth, 4-way stretch with stain resistant durable water repellent coating, 7 pockets including no-snag pen & knife pockets and hip & thigh stash pockets with bonded zippers. Available in sizes S-XL in crete and grain.

F15-0003 - \$143.65

**TRUEWERK
DOUBLE-STITCH
T2 WERKPANT**

Single layer unlined fabric with 4-way stretch with stain resistant durable water repellent coating, detailed with "hooded" no-snag pen/knife pocket, thigh and hip stuff pockets with bonded zippers and riveted corners. Available in sizes S-XL.

S16-0003 Pants - \$93.00

**TRUEWERK T.5
WERKPOLO**

Made with K115 Werkfabric's Ultraviolet Protection Factor blocking more than 95% of UV rays. Werkfabric's ability to quickly absorb moisture and promote evaporative heat loss enhances the body's natural cooling, keeping you not only more comfortable but reducing fluid loss which leads to dehydration and the accompanying loss of physical performance and mental acuity. In contrast to the performance fabrics offered in the recreational and sport markets, the Werkfabric has been engineered to score 4.5+ out of 5 for pick resistance, making it tough enough to survive repeated encounters with tree bark, wire rope, and rough-sawn timber. Available in sizes S-2XL in viz green, wolf grey, and black.

S17-0005 - \$44.00



NEW

**TRUEWERK T.5
SHORT SLEEVE
WERKTEE**

Blocks more than 95% of UV rays. Absorbs moisture and promotes evaporative heat loss enhances the body's natural cooling. Tough enough to survive repeated encounters with tree bark, wire rope, and rough-sawn timber. Available in sizes S-2XL in black, wolf grey, and green.

S17-0002 - \$34.00

**S17-0001 Long
sleeve - \$36.00**



**TRUEWERK X1
WERKSHIRT**

High collar to protect the back of your neck from sun; front, side and arms are mapped with a lightweight stretch woven fabric featuring a ripstop pattern for additional abrasion and tear resistance; reflective bars on both arms and back of neck to increase visibility; extended shirt tail; deep zip promotes venting and enables donning or doffing with helmet on. Available in sizes S-2XL.

X1-0001 - \$69.00



NEW

**TRUEWERK
BLACK-TIE T2
WERKFLEECE**

Stretch grid fleece is durable, lightweight, breathable & compressible; Features quick drying and wicking, flat-lock seams for comfort and durability, deep snap front closure and tailored fit, and zipper front pocket for storage. Available in sizes S-2XL.

S16-0002 - \$59.00



**TRUEWERK T1
TECH HOODY**

UPF 20 fabric blocks more than 93% of UV radiation for advanced protection from the sun; Features quick drying and wicking, collar snap, flat-lock seams for comfort and durability, hood can be worn over or under helmet. Available in sizes S-2XL in wolf grey and cone orange.

S16-0001 - \$67.00



**TRUEWERK
LOGO
WERKTEE**

Designed with performance and comfort in mind. 60/40 Poly-Cotton blend provides the perfect balance between moisture wicking / quick dry performance, ultra-soft feel and durability. Quality fabric and construction holds size and shape. Available in sizes S-2XL.

F15-0006 - \$24.00



HI-VISIBILITY 101

UNDERSTANDING THE ANSI STANDARD

The ANSI / ISEA 107-2015 is the new standard for approved High-Visibility gear. These classes are based on hazards on the job site, based on complexity, vehicular traffic, and speed.

All compliant hi-vis safety apparel must be balanced in design, with specific material requirements to meet the standard. No less than 40% of the minimum required reflective and background material has to be present on both the front and back of the garment, ensuring visibility from the front and back.

REQUIRED MARKINGS

FREE
DOWNLOAD

- Manufacturer's name
- Item Number
- Size
- ANSI / ISEA Standard including year
- Indication of compliance of flame resistance
- If not flame resistant, must show: "This garment is not flame resistant as defined by ANSI / ISEA 107-2015"
- Pictogram showing garment type, class, and level of reflective performance
- Maximum number of wash processes (i.e.: Max 50.)

PERFORMANCE CLASSES

ANSI 107
01

Class 1 (Type O Only): Provides minimum amount of hi-vis material required to differentiate worker visually from backgrounds around non-complex work environments. These garments are considered "Non-ANSI apparel".

ANSI 107
P2

ANSI 107
R2

Class 2 (Type R & P): These provided additional hi-vis materials and may allow design opportunities to define the human form more effectively. Class 2 garments typically provide longer detection and identification distances, and increased conspicuity performance compared to Class 1.

ANSI 107
P3

ANSI 107
R3

Class 3 (Type R & P): These offer greater visibility to the wearer in both complex backgrounds through a full range of body movements. Mandatory placement requirements for background, retroreflective and combined-performance materials on sleeves and pant legs. Sleeveless garments or vests are never considered Class 3.

ANSI 107
E

Class E: Supplemental apparel such as bibs, shorts, and gaiters, which are not compliant when worn alone, though, when combined with Class 2 or Class 3 apparel, the combination satisfies the Class 3 requirements.

GARMENT CATEGORIES

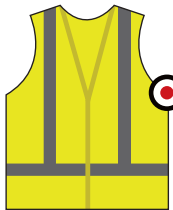

Type O - "Off Road"

Meant for off-road applications. This level of garment provides added visibility to workers who are not working around traffic. This level of Hi-Vis is common for parking lot attendants.



Type R - "Roadway"

These garments provide enhanced visibility for workers exposed to common highway traffic, working in more complex daytime and nighttime environments. This includes working in proximity to highway traffic, roadway temporary traffic control (TTC) zones, or from work vehicles and construction equipment within TTC zones.



Type P - "Public Safety"

This level of garment category is for emergency and incident responders, including law enforcement personnel. The standard requires less fluorescent background material to easily identify and distinguish personnel. It also permits shorter garments to make tactical access easier.

FABRIC & REFLECTIVE REQUIREMENTS BY TYPE & CLASS

GARMENT TYPE DESIGNATION	TYPE O	TYPE R		TYPE P	
PERFORMANCE CLASS	Class 1	Class 2	Class 3	Class 2	Class 3
BACKGROUND MATERIAL AMOUNTS	217 in ²	775 in ²	1,240 in ²	450 in ²	775 in ²
REFLECTIVE MATERIAL AMOUNTS	155 in ²	201 in ²	310 in ²	201 in ²	310 in ²
WIDTH MINIMUMS OF REFLECTIVE MATERIAL	1"	1.38"	2"	2"	2"



CUSTOMER CHOICE

ANSI 107
R2

SIZING CHART ONLINE



SAFETYGEAR CLASS 2 FOUR POCKET VALUE MESH VEST

Breathable polyester mesh, 2" silver reflective tape, zipper closure, (2) lower internal pockets, (2) upper chest pockets including (4) pen pockets, ANSI compliant. Available in sizes M-5XL in hi-vis lime and hi-vis orange.

302-MVGZ4P - \$8.99



ANSI 107
R3

SAFETYGEAR CLASS 3 FOUR POCKET VALUE MESH VEST

Breathable polyester mesh, 2" silver reflective tape, zipper closure, (2) lower internal pockets, (2) upper chest pockets including (4) pen pockets, ANSI compliant. Available in sizes M-5XL in hi-vis lime and hi-vis orange.

303-MVGZ4P - \$8.99



ANSI 107
R2

SAFETYGEAR TWO-TONE CLASS 2 SURVEYORS VEST

Durable solid polyester front and breathable mesh back, (6) pockets, zipper closure, 2" two tone tape for optimum visibility, ANSI compliant. Available in sizes M-5XL in hi-vis lime and hi-vis orange.

302-0500 - \$13.99



ANSI 107
R2

SAFETYGEAR CLASS 2 BREAKAWAY VEST

Breathable polyester mesh; 5 point breakaway; 2" two tone reflective tape; hook and loop closure; ANSI compliant; 2 upper chest pockets. Available in sizes M-5XL in hi-vis lime and hi-vis orange.

302-MV - \$14.99



ANSI 107
R3

SAFETYGEAR CLASS 3 BREAKAWAY VEST

Breathable polyester mesh; 5 point breakaway; 2" two tone reflective tape; hook and loop closure; ANSI compliant; 2 upper chest pockets; Available in sizes M-5XL in hi-vis lime and hi-vis orange.

303-5PMTT - \$14.99



GLOWEAR 8020HL NON-CERTIFIED STANDARD VEST

Made from polyester mesh with hook and loop closure. Available in hi-vis lime and hi-vis orange. Does not meet ANSI standards.

20040 - \$9.99



**PIP NON-ANSI
SHORT SLEEVE
T-SHIRT**

Made from 100% polyester birds eye mesh, durable lightweight performance wicking material, and (1) chest pocket. Available in sizes S-5XL in hi-vis lime and hi-vis orange. Non-ANSI garments are color enhanced and offer an additional level of safety for low risk activities, but do not meet ANSI standards. Available in sizes S-5XL in hi-vis lime and hi-vis orange.

310-CNTSN Short sleeve shirt - \$8.59
310-1100 Long sleeve shirt - \$11.49

ANSI 107
R2



2W CLASS 2 LONG SLEEVE SHIRT

Made from 100% polyester with (1) chest pocket. Available in sizes S-5XL.

TL125C-2 - \$12.99



ANSI 107
R2

**SAFETYGEAR
CLASS 2
SHORT SLEEVE
T-SHIRT**

100% polyester micro mesh, lightweight performance wicking material, left upper chest pocket, 2" silver reflective tape, grey collar, ANSI compliant. Available in sizes S-5XL in hi-vis lime and hi-vis orange.

312-1200 - \$13.49
313-1300 - Class 3 Long Sleeve \$16.79



ANSI 107
R3

**SAFETYGEAR
CLASS 3
SHORT SLEEVE
T-SHIRT**

100% polyester micro mesh, lightweight performance wicking material, left upper chest pocket, 2" silver reflective tape, ANSI compliant. Available in sizes S-5XL in hi-vis lime and hi-vis orange.

313-CNTSE - \$13.49



ANSI 107
R3

**SAFETYGEAR
CLASS 3 TWO-
TONE T-SHIRT**

100% polyester micro mesh, lightweight performance wicking material, left upper chest pocket, 2" silver reflective tape, ANSI compliant. Available in sizes S-5XL in hi-vis lime and hi-vis orange.

313-CNTSP - \$14.99



ANSI 107
R2

GLOWEAR 8295 TYPE R CLASS 2 POLO SHIRT

ANSI-compliant polyester breathable knit with moisture wicking treatment and split tail hem, 30+ UPF for protection against harmful UV, (1) outside chest pocket. Available in sizes S-5XL.

21642 - \$17.99

**TINGLEY ICON
LTE JACKET**

Polyurethane on 75 D ripstop polyester material. 2" silver reflective tape reflects light for 360° night time conspicuity. Lightweight, waterproof, mildew resistant, breathable material, while interchangeable liner options provide adaptability for all season comfort. Elastic cuffs with hook and loop take-up straps on sleeves. Roll-a-way adjustable hood in collar design, full-vented cape back, D-ring access, (4) pockets, exterior badge holder, 2 mic tabs. Available in sizes S-5XL.

J27122

S-XL - \$88.35

2XL-5XL - \$92.44



**TINGLEY ICON
LTE PANTS**

2" silver reflective tape reflects light for 360° night time conspicuity. Lightweight, waterproof, breathable material. Elastic waist pants with adjustable drawcord, hook and loop take-up straps on ankle cuffs, zippers at leg cuffs, and snap fly front. Available in sizes S-5XL.

P27122

S-XL - \$45.99

2XL-5XL - \$49.99

Overalls - 024122

S-XL - \$58.99

2XL-5XL - \$62.99



**PIP CLASS 3
RIPTOP
SOFTSHELL
JACKET**

Tri-laminate ripstop polyester softshell with fleece lining, removable fleece lined adjustable hood with zipper attachment, waterproof zipper closures, (4) outside pockets, (3) inside pockets, (2) mic tabs, drawstring waist adjustment. Available in sizes S-5XL.

333-1550 - \$69.99



**PIP CLASS
3 FULL ZIP
HOODED
SWEATSHIRT
WITH BLACK
BOTTOM**

ANSI/SEA 107 Class 3; 10 oz polyester fleece; zipper closure; water repellent shell treatment; 2" silver reflective tape; black bottom and cuffs to help hide dirt; front hand warmer pockets; left zippered chest pocket. Available in sizes M-5XL.

323-1370B - \$33.99

323-1350B Pullover - \$33.99

323-1330B 1/4 zip pullover - \$33.99



**PIP ANSI CLASS
E HEAVY DUTY
WATERPROOF
BREATHABLE BIB**

Waterproof breathable heavy duty 300 D 100% polyester shell, 3M Scotchlite reflective material, high-backed design, front fly opening with snap, front chest security pocket, adjustable cuffs. Available in sizes M-5XL.

353-2001 - \$34.99



**PIP ANSI CLASS 3
TWO-PIECE VALUE
RAINSUIT SET**

Class 3 apparel intended for workers requiring the highest level of visibility, lightweight polyester with waterproof PU coating and taped seams, 2" silver tape, zipper closure with storm flap, elastic waist pant with snap adjustable cuff, concealable hood for extra protection, ideal for rainy conditions in construction, municipalities, shipyards and anywhere hi-visibility is required and weather is a potential threat. Available in sizes S/M, L/XL, 2XL/3XL, 4XL/5XL.

353-1000 - \$40.99





GME SUPPLY "CLIMB HIGHER" T-SHIRT

Exclusive GME Supply "Climb Higher" design; quarter-turned to eliminate center crease; double-needle stitching throughout for increased durability; seamless rib at neck; taped shoulder-to-shoulder; pre-shunk short sleeve T-shirt; 100% cotton; available in sizes S-2XL.

10040 Red - \$12.99



GME SUPPLY "CLIMB HIGHER" FITTED HAT

Made from 98% cotton/ 2% spandex this FlexFit hat is made from cotton twill and offers an athletic, mid-profile design. The front of the hat displays "Climb Higher", and the side includes the GME Supply logo. Available in sizes: S/M (6-3/4" - 7-1/4") or L/XL (7-1/8" - 7-5/8").

12001 - \$24.99

{ SEE MORE GME SWAG
ON PAGE 208



GME SUPPLY "CLIMB HIGHER" HI-VIS SHORT SLEEVE T-SHIRT

Show your tower climbing pride with this custom designed "Climb Higher" T-shirt! Quarter-turned to eliminate center crease; double-needle stitching throughout for increased durability; seamless rib at neck; taped shoulder-to-shoulder; pre-shunk short sleeve T-shirt; 100% cotton; available in sizes S-2XL.

10090 - \$14.99



GME SUPPLY CUSTOM COMPANY LOGO SHIRTS

We've made outfitting your crew in identifiable, Custom Company Logo shirts easier than ever. These high-quality cotton work shirts include your one color (black) company logo on the chest and back for free. Whether you need shirts for one crew or your whole company, the price you pay will be significantly less than buying from your local T-Shirt shop. Ordering is simple. Choose your quantity and upload your logo. Need more than 200? Call for additional quantity discounts. A minimum order of 25 shirts is required for purchase. Available in short sleeve and long sleeve in sizes S-5XL in white, heather gray, hi-viz yellow, and hi-viz orange.

SEE PRICING BELOW

<p>STEP ONE CHOOSE STYLE</p>	<p>STEP TWO CHOOSE SHIRT COLOR Black logo on front and back of shirt</p>	<p>STEP THREE CHOOSE SIZES & QUANTITY Add \$2.00 per shirt in sizes 2XL-5XL</p>
<p><input type="checkbox"/> Short Sleeve <input type="checkbox"/> Long Sleeve</p>	<p><input type="checkbox"/> White <input type="checkbox"/> Hi-Viz Yellow <input type="checkbox"/> Heather Gray <input type="checkbox"/> Hi-Viz Orange</p>	<p><input type="checkbox"/> S <input type="checkbox"/> L <input type="checkbox"/> 2XL <input type="checkbox"/> 4XL <input type="checkbox"/> M <input type="checkbox"/> XL <input type="checkbox"/> 3XL <input type="checkbox"/> 5XL</p>

PART	DESCRIPTION	25 QTY	50 QTY	75 QTY	100 QTY	150 QTY	200 QTY
10300	WHITE SHORT SLEEVE	\$9.99	\$7.99	\$6.99	\$6.25	\$5.79	\$5.25
10310	HEATHER GRAY SHORT SLEEVE	\$10.99	\$8.49	\$7.49	\$6.99	\$6.25	\$5.99
10320	HI-VIZ YELLOW SHORT SLEEVE	\$11.49	\$8.75	\$7.75	\$7.25	\$6.49	\$6.25
10330	HI-VIZ ORANGE SHORT SLEEVE	\$11.49	\$8.75	\$7.75	\$7.25	\$6.49	\$6.25
10340	WHITE LONG SLEEVE	\$12.49	\$10.49	\$9.99	\$8.99	\$8.49	\$7.99
10350	HEATHER GRAY LONG SLEEVE	\$12.99	\$10.99	\$10.49	\$9.99	\$9.45	\$8.99
10360	HI-VIZ YELLOW LONG SLEEVE	\$13.49	\$11.49	\$10.99	\$10.49	\$9.99	\$9.49
10370	HI-VIZ ORANGE LONG SLEEVE	\$13.49	\$11.49	\$10.99	\$10.49	\$9.99	\$9.49

* Pricing per shirt



Try a pair of correctly fitted Oliver Boots for 30 days and, if you are not completely satisfied, return them for exchange or refund.



by Honeywell



OLIVER 6" LACE UP BOOT

Black water resistant full grain leather, comfort cushion system with poron, heavy duty dual density PU / rubber sole, heat resistant to 572° F, resists exposure to most acids and chemicals, nanolite footbed massages your feet as you walk to promote blood flow and reduce fatigue, poron XRD flexible internal metatarsal guard, qflex zero non-metallic penetration protection insole, tectuff toe bumper and heel protection, kevlar thread on critical seams, electrical hazard protection sole, natureform wide profile AS/NZS 2210.3 Type 1 toe cap protection, lace locking device, ASTM F2413-11 M I/75 C/75 MT/75 PR and EH. Available in sizes 6-15.

55-246 - \$139.99

OLIVER 8" LACE UP BOOT

Heavy duty all terrain dual density PU / rubber sole, heat resistant to 572° F, resists exposure to most acids and chemicals, natureform wide profile safety toecap, latex comfort liner to eliminate toe discomfort, nanolite footbed massages your feet as you walk to promote blood flow and reduce fatigue, comfort cushion impact absorption system with poron caustic and water resistant leather, poron XRD flexible internal metatarsal guard kevlar thread on critical seams, TPU safetycell for maximum protection and durability, anti-static sole, lace-in quick release zipper attachment, ASTM F2413-05 I/75 C/75 MT/75. Available in sizes 6-15.

65-392 - \$164.95

OLIVER 6" LACE UP BOOT

Heavy duty all terrain dual density PU / rubber sole, heat resistant to 572° F and resists exposure to most acids and chemicals, natureform wide profile safety toecap, latex comfort liner under the cap to eliminate toe discomfort, caustic and water resistant leather, kevlar thread on critical wear seams for maximum abrasion and chemical resistance, comfort cushion, nanolite footbed massages your feet as you walk to promote blood flow and reduce fatigue, superior slip resistance, exceeds SATRA Standards, integrated TPU safetycell, padded comfort collar, ASTM F2413-05 I/75 C/75. Available in sizes 6-15.

65-394 - \$139.99

OLIVER 6" LACE UP BOOT

Dual density nitrile rubber outsole with polyurethane midsole, comfort cushion uses cellular urethane and poron to protect the heel and ball of the foot, nanolite footbed massages your feet as you walk, water-resistant nubuck leather, outsole heat resistant to 572° F surface contact, heavy duty kevlar stitching across all critical seams, tectuff toe bumper and heel protection, lace locking device, excellent slip resistant sole, anti-static sole, superior cut, padded comfort collar and fully lined tongue, AS/NZS 2210.3 EN ISO 20345:2004, ASTM F2413-05. Available in sizes 6-15.

55-232 - \$129.99



TINGLEY FLITE SAFETY TOE BOOT WITH CLEATED OUTSOLE

Made from Aerex 1.5.5. — a proprietary, chemical-resistant, insulated, microcellular polymer, resulting in boots that are over 40% lighter compared to most steel toe PVC and rubber knee boots. Lightweight upper, cushioned heel, slip-resistant nitrile rubber outsole and composite toe provide superior comfort and safety. Tiny air bubbles trapped within the material keep feet warm in the cold and cooler in the heat. Composite safety toe meets ASTM F2413 M I/75 C/75 EH and will not set-off metal detectors. Available in sizes 5-15.

27251 - \$82.99



OLIVER SAFETY GUMBOOT

Heavy duty PVC / nitrile hard wearing sole, extra deep tread, open cleat sole for greater stability; gently raised surface of sole massages your feet as you walk to promote blood flow and reduce fatigue, outsole heat resistant to 266° F, steelflex steel midsole penetration protection, patented metprotect metatarsal protection, reinforced PVC design for greater ankle support and protection, sole resistant to solvents, mild acids, alkalis, some chemicals, oils and fats; superior cut, split and crack resistant sole; internal trouser grips, heel kick off spur, AS/NZS 2210.3. Available in sizes 6-14.

22-205 - \$99.99



NORTH AMERICAN SIGNAL 625 SERIES ST 2005 LIGHT

Bright, powerful, economical line of multi-voltage quad flash and double flash strobe lights, comes standard with a black ABS plastic base and fresnel lens, includes 75 lb pull magnet and 15' coiled cord and cigarette lighter plug with a built in ON/OFF switch. Lens color: amber, operating voltage: 12/24, rated current: 3 amperes, flashes per minute (FPM): 75 QF, joule rating - output energy: 10 joules, mounting: magnetic mount, diameter: 5.5", height: 6.25".

Q625HM-X - \$139.99



NORTH AMERICAN SIGNAL LED 400 SERIES HIGH POWER LED LIGHT

High impact LED warning light with a complete 360 degree display, flash pattern can be changed with button on base of light, (4) user-selectable patterns, universal mount aluminum flange base. Operating voltage: 12/24, rated current: 0.8 amperes, LED color: amber, lens color: amber, height: 5", diameter: 6.5", warranty: 5 years.

LED400-A - \$110.99



NORTH AMERICAN SIGNAL SAE CLASS 1 QUAD-FLASH MICROBURST LED WARNING LIGHT

Designed for vehicle applications where a small very bright light is required, features a conspicuous quad-flash pattern for a more attention-getting warning light. Operating voltage: 12/24, maximum current draw: 1.2 amperes, diameter: 4.6", flash pattern: 72 quad-flashes/min, warranty: 5 years, features: sonic-welded, polycarbonate housing; mounting: permanent mount, flange base; LED color: amber.

LEDQ375-A - \$119.99



NORTH AMERICAN SIGNAL LED TRAFFIC ASSIST

Designed to direct traffic around slow moving or stopped vehicles, features (16) LED lamp assemblies with (8) lamps in the body and (4) lamps each forming the arrows, (16) individual modes sequence from side to side in (3) different modes at (2) different speeds, (2) warning patterns for advance warning for oncoming traffic.

TA36L-A2 - \$749.99



NORTH AMERICAN SIGNAL LOW PROFILE LED MICRO-MINI BAR

Super low-profile all LED mini-bar with multiple patterns to choose from, including simulated revolving and random flash; polycarbonate dome, painted steel base, standard unit comes in 12 V, or 24 V unit, magnetic mount available on request, features "TRL" and "AGP" technology, maximizes LED light output.

MMBLEDLPR3-C/A - \$479.99



NORTH AMERICAN SIGNAL ECONOMY LOW-PROFILE LED MINI-BAR

Cycles thru (3) pre-programmed flash patterns, permanent mount. Operating voltage: 12/24 V, LED color: amber, dome color: clear, maximum current draw: 1.4 amperes, length of unit: 17.25", height: 2.75", depth: 9.4".

MMBSLEDFL-C/A - \$208.99



NORTH AMERICAN SIGNAL 4-LED SURFACE MOUNT LIGHT

Combines a small package with (4) high-impact 1-watt LEDs, chrome flange housing, weatherproof for indoor or outdoor use, (18) flash patterns to choose from. Also available in clear, blue, and red LEDs.

LED4001-X - \$64.99

CORTINA VINYL PENNANTS

60 pennants, 12" height, 9" width, 100' overall length, orange.

03-402 Orange - \$8.79

03-401 Red/white - \$7.79

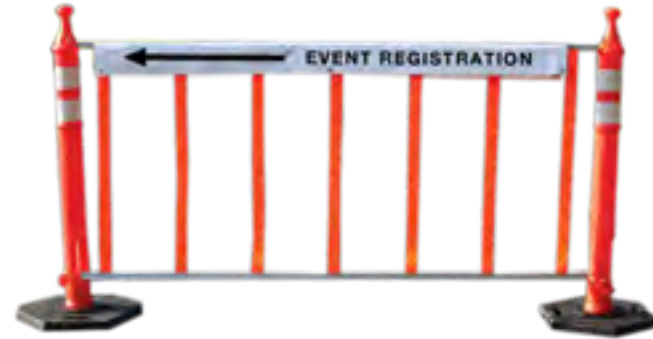

OMEGA ROLL UP SAFETY FENCE RUF PORTABLE BARRIER

First of its kind pedestrian safety barrier, innovative solution to protect dangerous work sites and pedestrian traffic zones. Stores in a fraction of the space of alternative products, constructed from high strength, lightweight aluminum, highly portable, can be moved quickly for emergency access, low wind resistance, more effective than caution tape or a single bar, bright international safety orange. 42" x 6'6".

RUF-6 - \$88.00

RUF-3 Roll up fence 3'3" - \$62.00

RUF-DT42-12 42" Delineator Post with 12 lb. Base - \$36.00

RUF-DT42-18 42" Delineator Post with 18 lb. Base - \$42.00



WORK AREA 42" CHANNELIZER CONE

High-impact, low density polyethylene with reinforced loop handle, (4) Hi-Intensity reflective stripes, includes CB16 16 lb base.

CC42 4-4HIP W/ CB16 - \$44.99



CORTINA 42" FLARED DELINEATOR POST

10 lb rubber base, (2) 3" reflective collars, EZ-Grab handle, 100% impact-resistant low-density polyethylene construction.

03-734RBC - \$39.99

03-732 Post - \$28.99

03-730 Base - \$12.99



JOHNSON "CAUTION" WARNING TAPE

High-visibility colors, easy to read black print, made from durable plastic.

3321 Yellow "CAUTION" 300' x 3" - \$6.95

3324 Yellow "CAUTION" 1,000' x 3" - \$12.95

3322 Red "DANGER DO NOT ENTER" 300' x 3" - \$6.95



CORTINA TRIANGLE WARNING KIT

Highway triangle warning kit, meets FMVSS 125, SAE-W4-74DOT, acrylic plastic strip reflectors, effective even for daytime use, impervious to dust and moisture, easy to unfold and mount on base, exceeds 40 mph wind test, custom hard plastic storage case included, fits under most vehicle seats.

95-03-009 - \$39.99



CORTINA VINYL FLAT

Handheld warning flag, 18" flag with 36" wooden dowel, reinforced heavy duty warning flag, fluorescent red-orange, ideal for directing traffic or warning motorists of upcoming construction.

03-229-3405 - \$3.39



CORTINA WARNING DIAMOND MESH FENCING

4' x 100', orange polyethylene, highly visible, UV stabilized, rugged and reusable, 23 lbs per roll, made in the USA.

03-901 - \$74.99

Qty 10+ - \$59.95



DICKIE SAFETY 18" STOP/SLOW PADDLE

High intensity reflective plastic, ABS orange 12" handle, meets all MUTCD specifications, unique snap together handle.

P18HIA 12" Handle - \$48.49

P51A 5' Handle extension - \$14.99

P61A 6' Handle extension - \$15.99

P52AT Telescoping handle - \$24.99



AERVOE 28" COLLAPSIBLE TRAFFIC SAFETY CONE

2.5 lb weighted base, 2 reflective stripes, blinking red LED beacon, includes storage case.

1191 1 pack - \$32.99

1192 3 pack - \$90.99



WORK AREA 28" TRAFFIC SAFETY CONE

6" and 4" reflective collars, 7 lb overall weight, all vinyl construction, ultraviolet stabilized color, high density base, low center of gravity for maximum stability, stackable.

28PVCTLS-6CC4CC - \$24.99



WORK AREA 12" TRAFFIC SAFETY CONE

12" fluorescent orange color, made from PVC, high density base, low center of gravity for maximum stability, stackable.

12PVCS-271452 - \$6.99



AERVOE YELLOW RECHARGEABLE SUPER LED ROAD FLAIR

Double the light output of standard LED Flair, does not produce flame, or smoke, 24 LEDs are visible for more than 7 miles, intrinsically safe design, 7 flashing patterns, submersible up to 50 feet, includes 120 V wall charger, 12 V car charger, storage bag.

1164 - \$49.99

1165 Safety Orange - \$49.99



NO PARKING CONE SIGN

Firmly mounts to top of cone, two sided, fits in any flexible traffic cone, rugged plastic sign, weather and fade resistant, safety orange with black text. 10" x 14".

FBC756 - \$39.99

FBC737 'Sidewalk Closed' - \$12.95



AERVOE SURVEY MARKING PAINT

Marking paint that will last up to 6 months, non-freezing, exceptional quality in terms of initial color brightness, color retention, adhesion, durability, and color consistency, formulated with superior quality raw materials, container size 17 oz. Aerosol, non-clogging, lead free, APWA/OSHA Colors, toluene free.

AV-207 White - \$4.99

AV-222 Fluorescent orange- \$4.99

AV-226 Fluorescent yellow - \$4.99

AV-229 Fluorescent pink - \$4.99



BONE SAFETY HI-INTENSITY REFLECTIVE SIGNS

3M Roll-Up Hi-Intensity Sign Sheeting Series RS30 consists of retroreflective microprisms formed on a flexible glossy and UV-stabilized polymeric film, provides higher nighttime sign brightness, protective film on the facing side, backed with a heavy duty vinyl coated fabric, bone corner pockets, anti-kiting devices, storage strap, reversible snaps and heavy duty fiberglass rib with anti-blooming.

36" x 36" - \$97.99

48" x 48" - \$145.99

BONE SAFETY NON-REFLECTIVE SIGNS

Constructed of a fabric reinforced UV stable vinyl, will not delaminate, provides excellent durability and fluorescence stability, suitable for maintenance and moving operations, intended for daytime use only, bone corner pockets, anti-kiting devices, storage strap, reversible snaps and heavy duty fiberglass rib with anti-blooming. Sign overlays options available.

36" x 36" - \$45.99

48" x 48" - \$69.99



CUSTOMIZABLE JOB SITE SAFETY SIGN & PORTABLE BASE

48" x 48" safety sign with 33-3/4" x 14-1/2" base, quickly and easily display OSHA 1910 and 1926 Subpart G required safety signs, made of Premium mesh material to ensure a long life, fade and tear resistant, one banner replaces (12) safety signs, includes custom logo.

2058 With logo - \$229.95

2057 No logo - \$209.95

MANY MORE
OPTIONS
AVAILABLE



BONE SAFETY RUBBER BASE SIGN STAND

100% recycled rubber, tough and lightweight, stackable, double grab handles, quick disconnect mast attachment, changing accessories takes less than 10 seconds; 38 lbs.

RBS - \$96.99

BONE SAFETY DUAL COIL SPRING SIGN STAND

Easy storage, pull pin and kick release of legs, (3) separate height adjustments for uneven terrain, bright orange legs for extra visibility on curbs and sidewalks, outdoor UV powder-coated and zinc plated for maximum corrosion resistance; 31 lbs.

412-2S - \$138.99

BONE SAFETY SINGLE SPRING SIGN STAND

Lightweight, pull pin and kick release of legs, (3) separate height adjustments for uneven terrain, bright orange colored legs for extra visibility on curbs and sidewalks, powder-coated and zinc plated for maximum corrosion resistance; 23 lbs.

412-S - \$101.99

BONE SAFETY SPRINGLESS SIGN STAND

Lightweight, oversized pull pins and kick release of legs, (3) separate height adjustments for uneven terrain, bright orange colored legs for extra visibility on curbs and sidewalks, powder-coated and zinc plated for maximum corrosion resistance; 20 lbs.

412 - \$96.99



RADIO FREQUENCY NOTICE SIGN

Available in aluminum or adhesive vinyl, features black lettering on a white background, 'Notice' at top in white lettering with blue background, post sign to warn workers to use caution where radio frequency could exceed the FCC rules for human exposure; 18" H x 12" W.

GW1218 Aluminum - \$19.99

GM1218 Adhesive Vinyl - \$9.99



RADIO FREQUENCY CAUTION SIGN

Available in aluminum or adhesive vinyl, features black lettering on a white and yellow background, post sign to warn workers to use caution where radio frequency could exceed the FCC rules for human exposure; 18" H x 12" W.

GCA121 Aluminum - \$19.99

GMC121 Adhesive Vinyl - \$9.99



RADIO FREQUENCY WARNING SIGN

Available in aluminum or adhesive vinyl, features black lettering on a white and orange background, post sign to warn workers to use caution where radio frequency could exceed the FCC rules for human exposure; 18" H x 12" W.

GMW121 Aluminum - \$19.99

GWA121 Adhesive Vinyl - \$9.99



NOTICE SIGN FOR RADIO FREQUENCY ENVIRONMENTS

Available in aluminum or adhesive vinyl, features black lettering on yellow background, sign serves to notify those working in an area where radio frequency is or could be present; 8" H x 12" W.

GMA812 Aluminum - \$12.99

GMV812 Adhesive Vinyl - \$5.49



CUSTOMIZABLE JOB SITE INFO SIGN

Customizable adhesive vinyl sign, Display company or carrier information, site ID, and phone number, features black lettering on white background with green top, sign notifies workers who operates the site and provides contact information; 8" H x 12" W.

GMIN81 Adhesive Vinyl - \$5.49



DANGER NO SMOKING STAINLESS STEEL SIGN

Made from durable stainless steel, four corner holes for easy mounting, hang sign to notify of a no smoking area; 14" H x 20" W.

GMN142 - \$85.99



DANGER FLAMMABLE LIQUIDS STAINLESS STEEL SIGN

Made from stainless steel for durability, four corner holes for easy mounting, hang sign to warn where flammable liquids are present; 14" H x 20" W.

GMS142 - \$85.99

QUANTITY DISCOUNTS AVAILABLE FOR ALL SIGNS! CALL (800) 940-6762.

SEE MORE BANNERS
ON PAGE 208



MOTIVATIONAL WORKPLACE BANNER

4' x 2' vinyl banner; designed to remind and encourage safety in any workplace; high contrast signs are easy to read and visible from a distance; made of premium extra-heavy duty UltraFlex 15 oz PVC material; capable of withstanding harsh outdoor environments; fade, tear, fungus, and scratch resistant; stable down to -20°F; grommets allow for convenient hanging; many designs available or customize your own!

- 2074 "Safety Is No Accident" - \$29.99
- 2083 "American Tower Climbers" - \$29.99
- 2070C Custom design, submit your print ready artwork - \$49.99



CUSTOMIZABLE JOB SITE SAFETY BANNER WITH POCKETS

5' x 3.5' vinyl safety sign banner, quickly and easily display OSHA required safety signs, (3) heavy duty pockets for convenient display of documents, made of premium extra-heavy duty UltraFlex 15 oz PVC material, capable of withstanding harsh outdoor environments, fade and tear resistant, outstanding scratch resistance, stable down to -20°F, treated for fungus resistance, grommets allow for convenient hanging.

- 2025 With logo - \$149.99
- 2020 No logo - \$129.99



CUSTOMIZABLE JOB SITE SAFETY BANNER

Vinyl safety sign banner, quickly and easily display OSHA required safety signs, made of premium extra-heavy duty UltraFlex 15 oz PVC material, capable of withstanding harsh outdoor environments, fade and tear resistant, outstanding scratch resistance, stable down to -20°F, treated for fungus resistance, grommets allow for convenient hanging.

- 2000 4' x 2' No logo - \$29.99
- 2005 4' x 2' With logo - \$49.99
- 2010 6' x 3' No logo - \$49.99
- 2015 6' x 3' With logo - \$99.99



FOLD UP JOB SITE SIGN

25" x 45" portable sign is made from 100% premium grade plastic for durability, made for outside use at the job site, molded handle allows for easy portability, weighs 21 lbs and can be weighed down internally with an additional 5 lbs of sand, sign area 24" x 36", many designs available or customize your own!

- 2301 "Danger Workers Above / Caution" - \$149.99
- 2304 "Do Not Enter" - \$149.99
- 2310 Custom Logo Tower - \$174.99
- 2313 Custom design, submit your print ready artwork - \$174.99



BOTTOM FEED CABLE TO VERTICAL PIPE DOWN

PART	WIRE SIZE	PIPE SIZE	WELD METAL	PRICE
VSC-1V-V3C	2 Strand	1-1/4"-4"	#45	\$103.00
VSC-1T-V3C	2 Solid	1-1/4"-4"	#45	\$103.00
VSC-1T-V5C	2 Solid	4"-6"	#45	\$103.00
VSC-2G-V3C	2/0	2"-4"	#90	\$103.00
VSC-2Q-V3C	4/0	2"-4"	#115	\$103.00

TOP FEED CABLE TO VERTICAL PIPE UP

PART	WIRE SIZE	PIPE SIZE	WELD METAL	PRICE
VFC-1V-V3C	2 Strand	1-1/2"-4"	#65	\$103.00
VFC-1T-V3C	2 Solid	1-1/2"-4"	#65	\$103.00
VFC-1T002-V3C	2 Solid 45°	1-1/2"-4"	#65	\$103.00

ANGULAR CABLE DROP TO VERTICAL STEEL SURFACE

PART	WIRE SIZE	WELD METAL	PRICE
VSC-1T	2 Solid	#65	\$103.00

OVERHEAD VERTICAL TAP TO VERTICAL STEEL SURFACE

PART	WIRE SIZE	WELD METAL	PRICE
VFC-1T	2 Solid	#45	\$103.00

WIRE TO VERTICAL PIPE STRAIGHT DOWN

PART	WIRE SIZE	PIPE SIZE	WELD METAL	PRICE
VBC-1V-V3C	2 Strand	1-1/4"-4"	#65	\$103.00
VBC-1T-V3C	2 Solid	1-1/4"-4"	#65	\$103.00
VBC-2G-009	2/0	1-1/4"-3-1/2"	#90	\$103.00
VBC-2Q-003	4/0	1-1/4"-3-1/2"	#115	\$103.00

HORIZONTAL WIRE TO HORIZONTAL PIPE

PART	WIRE SIZE	PIPE SIZE	WELD METAL	PRICE
HAA-1T-162C	2 Solid	1-1/4"-2"	#45	\$103.00
HAA-1T-350C	2 Solid	3"-4"	#45	\$103.00

CABLE TO TOP OF GROUND ROD

PART	WIRE SIZE	ROD	WELD METAL	PRICE
GRC-161T	2 Solid	5/8"	#65	\$103.00

HORIZONTAL CABLE TO HORIZONTAL BUS BAR

PART	WIRE SIZE	WELD METAL	PRICE
LJC-EG1V	2 Strand	#65	\$103.00
LJC-EG1T	2 Solid	#65	\$103.00
LJC-EG2G	2/0	#90	\$103.00
LJC-EG2Q	4/0	#65	\$103.00

THROUGH CABLE TO TOP OF GROUND ROD

PART	WIRE SIZE	ROD	WELD METAL	PRICE
GTC-161T	2 Solid	5/8"	#90	\$103.00
GTC-181T	2 Solid	3/4"	#90	\$103.00
GTC-162G	2/0	5/8"	#115	\$103.00
GTC-162Q	4/0	5/8"	#115	\$103.00

CABLE TO CABLE PARALLEL SPLICE

PART	WIRE SIZE	WELD METAL	PRICE
PTC-1T1V	2 Solid to 2 Strand	#65	\$103.00
PTC-1T1T	2 Solid to 2 Solid	#65	\$103.00
PTC-2G1T	2/0 to 2 Solid	#90	\$103.00
PTC-2G2G	2/0 to 2/0	#115	\$103.00
PTC-2Q1T	4/0 to 2 Solid	#150	\$103.00
PTC-2Q2Q	4/0 to 4/0	#200	\$103.00

HORIZONTAL END TO END

PART	WIRE SIZE	WELD METAL	PRICE
SSC-1T	2 Solid	#32	\$103.00
SSC-2G	2/0	#65	\$103.00

RUN AND TAP OR 3-WAY

PART	RUN WIRE	TAP WIRE	WELD METAL	PRICE
TAC-1T1T	2 Solid	2 Solid	#45	\$103.00
TAC-2G2G	2/0	2/0	#90	\$103.00

MOLD SEALER

Ideal for sealing hot or cold molds to retard leakage.

T403 - \$19.99

ELECTRONIC IGNITER

Initiates the reaction of the metal crucible, includes a 6' lead that attaches to the ignition strip and 8 AA batteries.

PLUSCU - \$133.99

HANDLE CLAMP

Used for most molds, includes flint igniter. Offset handle reduces labor time and can fit in a smaller hole.

L160 - \$57.99

CHAIN HANDLE CLAMP

Secure molds to vertical pipe, 20" chain for pipes up to 4", includes flint igniter, can be used with or without chain.

B160V - \$114.99

B-158 20" extension chain - \$16.35

FLINT IGNITER

Available separately, but included with each handle clamp.

T320 - \$6.99

T320A Replacement flints (10 pack) - \$5.95

ADAPTER SLEEVES

Changes 2 stranded molds to 6 stranded, 25 pack.

B112 - \$6.99

B140A Wrap sleeves (50 pack) - \$17.95

MOLD CLEANING BRUSH

Useful in removing slag from molds, especially vertically split.

T394 - \$7.79

Many more options available. Call a gear expert for more information.

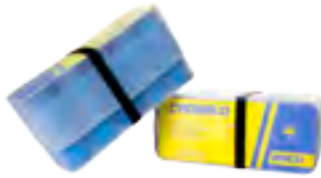

WELD METAL

Cadweld weld metal is a mixture of copper oxide and aluminum, packaged by size in plastic tubes. Each tube contains the starting powder at the bottom of the plastic tube, with the weld metal on top. These containers are packaged, with metal disks, in polyethylene boxes. The welding metal cannot ignite spontaneously. They can be handled and stored without danger and can be shipped with no special packaging or marking.

PART	WELD METAL	CASE QTY	PRICE
#32-CASE	#32	20	\$55.00
#45-CASE	#45	20	\$79.00
#65-CASE	#65	20	\$90.00
#90-CASE	#90	10	\$65.00
#115-CASE	#115	10	\$85.00
#150-CASE	#150	10	\$110.00
#200-CASE	#200	10	\$135.00

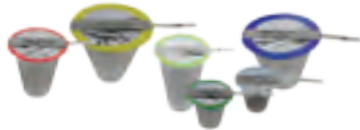

PLUS WELD METAL

Cadweld Plus weld metal consists of disposable, moisture resistant weld metal cup. Weld metal, disk, and ignition source are located inside package. No need for disks, starting materials, igniters etc. Reduce installation time by 20%. Use ordinary Cadweld molds and get perfect results every time. Using the electronic ignitor, welds are made with the installer 6 feet away.

PART	WELD METAL	CASE QTY	PRICE
#32PLUS-CASE	#32	20	\$59.85
#45PLUS-CASE	#45	20	\$82.25
#65PLUS-CASE	#65	20	\$102.35
#90PLUS-CASE	#90	10	\$71.25
#115PLUS-CASE	#115	10	\$89.25
#150PLUS-CASE	#150	10	\$111.75
#200PLUS-CASE	#200	10	\$138.65



CABLE TO CABLE MOLD

Forms a permanent low resistance connection and provides molecular bond; exothermic connections are rated with the same current capacity as the conductor and can be visually inspected; portable installation equipment with no external source of power required.

PTP-1T1T - \$136.99

**KITS
SAVE
CASH**



CADWELD PLUS ELECTRONIC EXOTHERMIC WELDING DELUXE KIT

Kit includes PLUSCU Cadweld electronic control unit, L160 standard handle with flint igniter, B160V chain handle with flint igniter, #45 case weld metal (20 shots), (2) #65 cases weld metal (40 shots), #90 case weld metal (10 shots), PTC-1T1T 2 solid parallel splice mold, TAC-1T1T solid "T" mold, LJC-EG1T 2 solid bus bar mold, GTC-161T 2 solid through 5/8" ground rod mold, VSC-1T-V3C 2 solid vertical down from pipe mold, VFC-1T-V3C 2 solid vertical up from pipe mold, HAA-1T solid horizontal to flat steel mold, T394 mold cleaning brush, T403 mold sealer.

8075 - \$1,168.99



CADWELD EXOTHERMIC WELDING DELUXE KIT

Kit includes L160 standard handle with flint igniter, B160V chain handle with flint igniter, #45 case weld metal (20 shots), (2) #65 cases weld metal (40 shots), #90 case weld metal (10 shots), PTC-1T1T 2 solid parallel splice mold, TAC-1T1T solid "T" mold, LJC-EG1T 2 solid bus bar mold, GTC-161T 2 solid through 5/8" ground rod mold, VSC-1T-V3C 2 solid vertical down from pipe mold, VFC-1T-V3C 2 solid vertical up from pipe mold, HAA-1T solid horizontal to flat steel mold, T394 mold cleaning brush, T403 mold sealer.

8051 - \$999.99



CADWELD 8025 WELDING STARTER KIT

Kit includes L160 EZ-change 3" handle clamp, PTC-1T1T solid parallel splice mold, TAC-1T1T solid "T" mold, LJC-EG1T solid bus bar mold, GTC-161T solid through 5/8" ground rod mold, #45 case weld metal (20 shots), #65 cases weld metal (40 shots), #90 case weld metal (10 shots), T394 mold cleaning brush, T403 mold sealer.

8025 - \$649.99



CADWELD 8035 WELDING STARTER KIT

Kit includes B160V chain handle with flint igniter, VSC-1T-V3C solid vertical down from pipe mold, VFC-1T-V3C solid vertical up from pipe mold, #45 case weld metal (20 shots), #65 cases weld metal (40 shots), HAA-1T solid horizontal to flat steel mold, T394 mold cleaning brush, T403 mold sealer.

8035 - \$519.99

ERICO

ERICO is the pioneer of the CADWELD Exothermic Welding Process for permanent Cathodic Protection connections. Specifying the CADWELD process in your construction plans will dramatically extend the lifespan of infrastructure systems. CADWELD connections are made with a semi-permanent graphite mold, which holds the conductors to be welded. Weld metal (a mixture of copper oxide and aluminum) is dumped into the top of the mold. The mold is covered and the weld metal ignited. The exothermic reaction produces molten copper, which results in a permanent, high conductivity connection. A CADWELD Connection has current carrying capacity equal to that of the conductor, is permanent with a low resistance connection that cannot loosen or corrode, uses lightweight, inexpensive equipment, requires no external source of power or heat, and can be easily checked for quality.

INDUSTRIAL COATINGS 101

COLD GALV

Cold galvanizing compound is a single-component zinc coating used to protect bare steel from rust and corrosion. Although it is applied like paint, it is not. It gives the same protection as hot dip galvanizing. The higher the zinc content, the higher the protection against the elements from rust and corrosion. The zinc bonds to the steel to form the protective layer, and the higher the zinc content, the better the coverage and protection.

SURFACE PREP

The surface must be clean, dry steel. Use a steel brush to remove any existing rust on the surface for the entire area that will be covered in cold galvanizing compound. Also, remove any chemicals, dirt, grease, oil, silicon, etc. from the surface before applying cold galv.

APPLICATION

Cold galv can be painted on using traditional brushes, rolled, and even sprayed using a thinner. Aerosol coatings are also available. We recommend a disposable brush like the 3" chip brush. Be sure to review the conditions for your particular brand of cold galv, but most of the compounds can be applied in a wide variety of weather conditions. Humidity can even intensify the anodic action and acceleration of the protective formation.

SHIPPING

Cold galvanizing compound can only be sent via ground or LTL. It is not allowed in the air system due to its category 3 classification for flammable liquids.

TOWER PAINT

TowerPlex coatings are designed and formulated to be durable, long-lasting protection for galvanized towers and other metal surfaces. They're 100% acrylic and meet all federal standards for aviation safe colors.

The alkalinity of the paint etches into the zinc in galvanized surfaces unlike other ordinary enamel paints, so it actually forms a chemical bond to the tower.

PRIMER

The paint works best with its matching primer. You'll want to prime any rusted areas. If you plan to spray on the paint, a full coat of primer is recommended.

APPLICATION

Before applying prep the surface in a similar fashion to cold galv. The paint can be applied between 50° and 110° Fahrenheit. Coverage is different for every situation, but theoretical coverage is 588 sq/feet per gallon at 1 mil dry.

It can be applied using a brush, mitt, or spray. Ideally a full wet coat is applied overlapping 50% each pass to avoid dusting. The paint should dry overnight, and avoid painting if a freeze or rain is possible in the next 24 hours.

COMPLIANCE

Use a color chart to test whether your tower needs to be painted. They are specially designed charts calibrated with color swatches which meet the FAA guidelines for aviation safe colors.

All products referenced in this article can be found on [pages 164-165](#).



WATCH THE VIDEO ON OUR
YOUTUBE CHANNEL

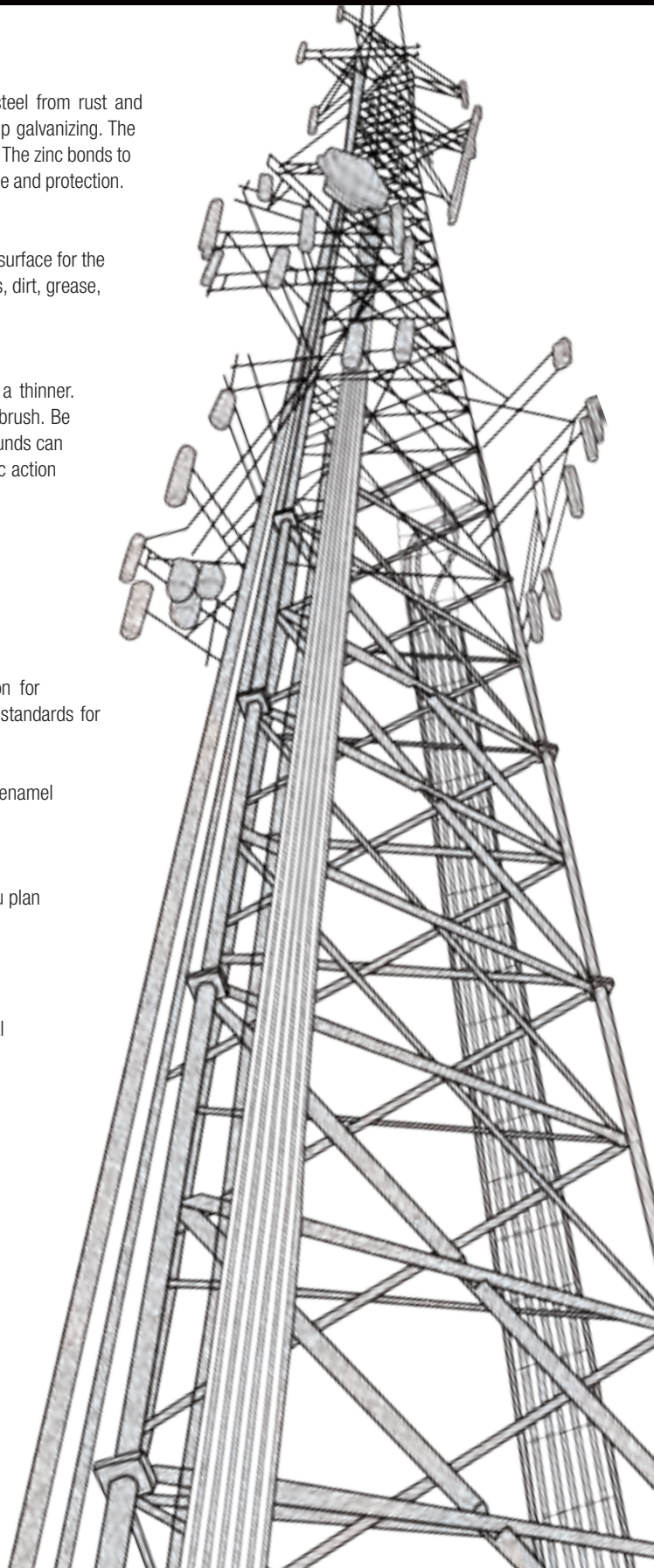



CROWN BRITE COLD GALVANIZING COMPOUND

Bright, glistening finish with 65% pure zinc in a dry film, can be easily sprayed, brushed, or dipped onto any metal surface, meets performance requirements of ASTM A-780-93A, good film integrity after 336 hours salt spray, designed for permanent protection, stops rust and corrosion on any iron or steel surface for protection equal to or better than hot-dipped galvanizing with the bright look of hot-dipped surfaces.

- 7008G 1 gallon - \$124.99
- 7008VG Low VOC 1 gallon - \$206.99
- 7008Q Quart - \$34.99
- 7008 12 pack aerosol - \$96.99



CROWN COLD GALVANIZING COMPOUND

Light gray, matte finish with 93% pure zinc in a dry film, can be easily sprayed, brushed, or dipped onto any metal surface, meets performance requirements of MIL-P-46105(MR), MIL-P-21035B, and DOD-P-21035A, withstands 2000 hours of 5% salt spray testing, designed for permanent protection, provides protection equal to or better than hot-dipped galvanizing, outstanding weld-through primer.

- 7007G 1 gallon - \$118.99
- 7007VG Low VOC 1 gallon - \$189.99
- 7007Q Quart - \$34.99
- 7007 12 pack aerosol - \$79.99



ZRC GALVILITE GALVANIZING REPAIR COMPOUND

Shiny finish with 95% pure zinc in dry film, low VOC, withstands 3,000 hours salt spray testing, designed specifically for field and shop repair of hot dip galvanizing, silver finish closely blends with the color of new hot dip galvanizing, meets or exceeds galvanizing repair specifications, single-component, apply by brush, roller, or spray; passes 9-year subtropical testing, resists intermittent dry-heat temperatures of up to 750°F, also available in clog-free aerosol form.

- 20013 1 gallon - \$159.99
- 20012 Quart - \$41.99
- 20010 24 pack aerosol - \$259.99

ANCHOR STAINLESS STEEL SHOE HANDLE WIRE BRUSH

Heavy-duty industrial brush, unsurpassed wire fill and length, designed to outwork and outlast so called "economy" brushes.

387SS - \$2.79

3" WOOSTER CHIP BRUSH, 12 PACK

Chip brush head features white Chinese bristle; natural wood handle is lightweight for comfortable use; tin-plated steel ferrule; brush is disposable, and easy to use, sold in packs of 12.

1117 - \$9.79



ZINGASOLV

Zingasolv is the recommended thinner to be used with Zinga for spray application, can also be used for cleaning equipment, it's recommended to dilute by 0 to 5% for conventional spraying and 0 to 25% for airless spraying. (1) Liter.

- ZSOL1 1 Liter- \$18.00
- ZSOL5 5 Liter - \$80.00



ZINGA ZINC FILM COLD GALVANIZING COATING

96% zinc in the dry film - the highest zinc purity in the world, provides cathodic protection to steel, dry to touch in 10 minutes, (1) gallon.

- Z10 1 Gallon - \$349.99
- ZC (12) pack aerosol - \$298.00
- Z5 1/2 gallon - \$183.00
- Z1 12.5 ounces - \$44.99



ZRC COLD GALVANIZING COMPOUND

Flat finish with 95% pure zinc in dry film, low VOC, withstands 3,000 hours salt spray testing, (1) gallon.

- 10003 1 Gallon - \$149.99
- 10000 24 pack aerosol - \$257.99
- 10002 Quart - \$41.99

TowerPlex



**COMPLIES WITH
FAA STANDARD**

GME
Supply Co



INDUSTRIAL SUPPLIES // TOWER PAINT

**TOWERPLEX AVIATION
WHITE TOWER PAINT**

100% acrylic emulsion coating formulated for use on galvanized antenna towers, dries quickly and has excellent weathering properties, meets Federal Standard 595 color #17875 White and complies with National Bureau of Standards report NBS1R75-663 and F.A.A. A/C70/7460-1H.

CC2919 (1) gallon - \$38.99
(5) gallons - \$177.99

TOWERPLEX ACRYLIC BONDING PRIMER

100% pure acrylic emulsion maintenance/shop primer that develops barrier corrosion resistance, normally associated only with solvent-borne primers. This primer offers excellent adhesion to various substrates such as structural steel, aluminum, galvanized, concrete, masonry, and wood.

CC2925 (1) gallon - \$61.99
(5) gallons - \$287.99

**TOWERPLEX AVIATION
ORANGE TOWER PAINT**

100% acrylic emulsion coating formulated for use on galvanized antenna towers, dries quickly and has excellent weathering properties, meets Federal Standard Color #12197 Orange and complies with National Bureau of Standards report NBS1R75-663 and F.A.A. A/C70/7460-1H.

CC2920 (1) gallon - \$48.99
(5) gallons - \$227.99



**FAA IN-SERVICE ORANGE
COLOR RANGE CHART**

By visually comparing the chart to the tower by way of the window on each page, one can determine whether it is necessary to repaint the tower or obstruction to bring the markings back into compliance. The chart is comprised of 18 technically matched and certified color blocks (nine per page) which represent the minimum and maximum color saturation, as well as limits for lightness, darkness, redness and yellowness compliances.

AA-4200 - \$59.99

**WOOSTER PAINTER'S
HAND MITT**

This lined glove is ideal for painting cellular communication towers, cell monopoles, angle steel, pipes, ornamental iron, hand railing, and more both quickly and efficiently. For use with all paints. Can also be used for cleaning, polishing, dusting.

R044 - \$4.99



**DUPONT TYVEK
COVERALL PAINT SUIT**

Offers an inherent barrier to particles down to 1 micron in size, attached hood with elastic around face opening, designed to cover neck and chin and fit around respirator face mask, available in sizes XL and 2XL.

TY127S - \$7.39



(800) 940-6762

165



KIDDE ABC HOME FIRE EXTINGUISHER

Designed to fight basic fires common to the home, including those involving fabrics, plastics, wood, flammable liquids, and electrical equipment; U.S.C.G. DOT approved, UL rated 1-A:10-B:C, unit weight 2.5 lbs, diameter 3.25", height 13.75", discharge time 8-12 seconds, discharge range 6-8', operating pressure 100 psi.
466142 - \$28.99



KIDDE PRO 20 MP FIRE EXTINGUISHER

Multipurpose dry chemical, UL listed, UL rated 6-A:80-B:C, supplied with wall hanger, monoammonium phosphate, 6 year limited warranty, suitable for use on most common fires, unit weight 30 lbs, diameter 7", height 21.6", discharge time 19-22 seconds, discharge range 20', operating pressure 195 psi.
466206 - \$119.99



KIDDE PRO 10 MP FIRE EXTINGUISHER

Multipurpose dry chemical, UL listed, UL rated, 60-B:C, supplied with wall hanger, monoammonium phosphate, 6 year limited warranty, suitable for use on most common fires, unit weight 16 lbs, diameter 5.21", height 19.52", discharge time 19-21 seconds, discharge range 20', operating pressure 195 psi.
466204 - \$69.99



KIDDE PRO 5 MP FIRE EXTINGUISHER

Multipurpose dry chemical, UL listed, UL rated 3-A, 40-B:C, supplied with wall hanger, monoammonium phosphate, 6 year limited warranty, suitable for use on most common fires, unit weight 9 lbs, diameter 4.5", height 16.31", discharge time 13-15 seconds, discharge range 12-18', operating pressure 195 psi.
466112 - \$49.99



KIDDE FIRE EXTINGUISHER BRACKET

Durable steel construction, metal retention strap to hold extinguisher, wall bracket for dry chemical fire extinguisher, fits variety of Kidde extinguisher models.
408-466401 - \$7.99



KIDDE FIRE EXTINGUISHER BRACKET

Manufactured with the highest quality, durable, high strength metal; mounts on wall or work truck; versatile and fits many Kidde Fire Extinguishers; secure fire extinguisher so it's ready at a moment's notice in an emergency.
408-292474 - \$56.60



ACCUFORM ADHESIVE VINYL FIRE EXTINGUISHER SIGN

Fire extinguisher signs identify the location and sometimes the type of fire extinguisher to aid with deployment in case of emergency. 4" x 12".
MFxG543VS - \$5.86



GENERAC XP SERIES 6500E PORTABLE GENERATOR

Full panel GFCI protection, idle control, integrated lifting eye, 120/240 V, electric start, Generac's OHVI engine, durable construction with hardened 1.25" steel tube cradle and cast metal corners, TruePower technology, low oil pressure shutdown, on/off switch, fuel shut-off and choke controls, covered outlets, locking, folding handles and never-flat wheels are included; maintenance kit included, 6,500 watt.
5930 - \$2,039.00



GENERAC GP SERIES 7500E PORTABLE GENERATOR

Electric start, Generac's OHV engine, large-capacity steel fuel tank, low-oil level shutdown, hardened steel tube cradle, fold-down handle, never-flat wheels; CSA and CARB certified, 7,500 watt.
5943 - \$999.00



GENERAC GP SERIES 6500 PORTABLE GENERATOR

Generac's OHV engine, large-capacity steel fuel tank, low-oil level shutdown, hardened steel tube cradle, fold-down handle, never-flat wheels; CSA and CARB certified, 6,500 watt.
5940 - \$799.00
5941 Electric start - \$899.00



GENERAC GP SERIES 3250 PORTABLE GENERATOR

Generac's OHV engine, large-capacity steel fuel tank, low-oil level shutdown, hardened steel tube cradle, fold-down handle, never-flat wheels; CSA and CARB certified, 3,250 watt.
5982 - \$439.00



GENERAC GP SERIES 1800 PORTABLE GENERATOR

Generac's OHV engine, large-capacity steel fuel tank, low-oil level shutdown, hardened steel tube cradle, fold-down handle, CSA certified, 1,800 watt.
5981 - \$359.00



GENERAC XP SERIES 8000E PORTABLE GENERATOR

Full panel GFCI protection, idle control, integrated lifting eye, 120/240 V selector, Generac's OHVI engine, durable construction with hardened 1.25" steel tube cradle and cast metal corners, TruePower technology, low oil pressure shutdown, on/off switch and fuel shut-off, covered outlets, handle and wheel kit, maintenance kit included, 8,000 watt.
5931 - \$2,449.00



SOUTHWIRE 1,000 WATT TWIN HEAD WORK LIGHT

16,000 lms; twin head lamps rotate 360-degrees; fixture telescopes up to 42" tall; 4' 18/3-gauge cord and cord storage bracket; all metal construction with hinged face; UV protected tempered safety glass; one weatherproof power switch per lamp for individual control.

L13SW - \$26.50



MILWAUKEE M18 CORDLESS FLOOD LIGHT

Up to 30% brighter than corded 250 halogen lights; up to 8 hours of run-time; octagonal shape allows light to be used at multiple angles; integrated EMT hanger, key hole hanger, cross bar hanger, handle hanger for hands-free use.

495-2361-20 - \$98.99



STREAMLIGHT DOUBLE CLUTCH USB HEADLAMP

Flexibility of shifting between beams and modes to fit your task, as well as choosing your battery source. Use even with gloves, just a quick twist of the facecap turns the light on and off, or changes the output from spot to flood.

61602 - \$56.99



RAYOVAC VIRTUALLY INDESTRUCTIBLE FLASHLIGHT

High performance LED, (2) modes: 120 lumens, 19 lumens, beam distance: 160 meters, 70 meters, battery run time: up to 40 hours, 30' drop test performance, lifetime warranty.

DIY3AAA-B - \$29.99



MILWAUKEE M12 LED LANTERN / FLOOD LIGHT

10.6" length; 400 lms; 180°-360° adjustable beam allows user to select between area and task lighting; 4 light settings; impact resistant lens and withstands 6' drops; 2 stainless steel hooks.

495-2362-20 - \$100.00



SOUTHWIRE IN-LINE GFCI TRI-SOURCE

2' length, 120 V rating, 15 amp, rainproof, SJTW-A wire type, Reset and manual test buttons, NEMA 5-15 to NEMA 5-15R.

26020008-6 - \$24.96

MILWAUKEE M18 ROCKED LED TOWER LIGHT

Rotating and pivoting head extends from 4'-7'; compact 26" footprint with low center of gravity; 2,000 lms; 3 optimal output modes for optimal brightness and runtime; low battery indicator alerts users when battery is nearing end of charge; impact resistant; reinforced legs.

495-2130-20 - \$249.99



RAYOVAC BATTERIES

PART	BATTERY TYPE	QUANTITY	PRICE
ALAA-24	AA	24	\$11.99
ALAAA-24	AAA	24	\$11.99
ALC-12	C	12	\$10.99
ALD-12	D	12	\$14.99
AL9V-12	9V	12	\$23.99



SOUTHWIRE EXTENSION CORDS

PART	GA/COND	LENGTH	125 V RATING	PRICE
2587SW8802	12/3	25'	15A	\$20.99
2588SW0002	12/3	50'	15A	\$49.99
2589SW0002	12/3	100'	15A	\$69.99
2688SW8802	10/3	50'	15A	\$99.99
2689SW8802	10/3	100'	15A	\$129.99



18509



FE7220



FE3224



FS1510

LITTLE GIANT AERIAL SAFETY CAGE LADDER

The only aerial access equipment constructed of nonconductive, high strength fiberglass. Self-enclosing platform is a versatile, safe environment. Safe over uneven surfaces, stairs. Complies with upper-floor weight limitations. Adjusts in one-foot increments.

- 18503 3'-5' - \$1,379.99
- 18509 5'-9' - \$1,987.99
- 18515 8'-14' - \$2,578.99

LOUISVILLE EXTENSION LADDER

Non-conductive fiberglass extension ladder carries a 300 lb load capacity; features fully serrated D-shaped rungs for a slip resistant surface, non-marring rail end caps, full metal boot, and aluminum plate connection rungs.

- FE7220 20' - \$324.99

LOUISVILLE EXTENSION LADDER

Extra heavy-duty extension ladder can hold up to 300 lbs and made from non-conductive fiberglass; Comes equipped with outside slide guides, D-shape rungs, non-marring rail end caps, QuickLatch rung lock, and swivel safety shoes.

- FE3216 16' - \$195.99
- FE3224 24' - \$249.99
- FE3232 32' - \$399.99

LOUISVILLE STEP LADDER

Extra heavy-duty, the step ladder can hold up to 300 lbs and made from non-conductive fiberglass; Comes equipped with Da Boot for slip resistant footing, a molded top with hardware tray, paint can holder, handyman's tool slots, pipe holder, and a magnet to secure small steel parts.

- FS1506 6' - \$102.99
- FS1508 8' - \$134.99
- FS1510 10' - \$198.99



LADDER STEP GUARD SAFETY SIGN

11" X 14" sign made from 3 mm PVC acrylic with a laminated cover for durability, English and Spanish safety notices, mounting holes can be custom drilled by end user to fit every ladder, easily attach sign using zip ties, sign can be trimmed for smaller ladders.

- 2801 - \$14.99
- 2802 10 signs - \$129.99

GUARDIAN SAFE-T LADDER EXTENSION

Designed to attach over the top of the ladder and provide a safe and easy transition from the ladder to a second surface, requires no tools.

- 10800 - \$169.99



GUARDIAN LADDER HOOK

Adjusts to fit between top (2) ladder rungs, fits single or extension, wood, fiberglass, and aluminum ladders with round or "D" rung styles.

- 2480 - \$21.99



LADDER LOCK

Helps prevent accidents and property damage, easy to use, constructed of steel with a strong spring for holding power, clamps onto gutters, metal roofs, piping, plywood and much more.

- LADDERLOCK - \$36.99





ACCUFORM GROUP LOCKOUT JOB TAGS

5 pack of nearly indestructible laminate lockout job tags; withstands tough, abusive conditions; hard-sealed by thick laminate on both sides; tear-proof, weather proof; chemical-resistant; withstands dirt, grease, liquid splashes, etc; 3/8" hole with reinforced pull-proof metal grommet; 5-3/4" x 3-1/4".

MDT251LTM 5 Pack - \$12.49

MDT251LTP 25 Pack - \$54.99



MASTER LOCK ZENEX 10 LOCK PADLOCK STATION

Covered padlock station with (10) of the 410RED Zenex padlocks, keyed differently; (2) 420 hasps and (2) bags (12/pack) of 497A Danger Do Not Operate lockout tags, lockable translucent cover, 15-1/2" high, 22" wide, 1-3/4" deep.

1483BP410 - \$269.99



MASTER RED ZENEX THERMOPLASTIC SAFETY PADLOCK

1-1/2" wide, 1-3/4" tall Thermoplastic black body, shackle with 1-1/2" clearance, key retaining - ensures that padlock is not left unlocked.

410RED - \$12.99



MASTER LOCK GRIP TIGHT CIRCUIT BREAKER LOCKOUT

Fits wide or tall breaker toggles typically found on hi-voltage/hi-ampereage breakers, great strength with universal fit.

491B - \$8.19

493B Standard Toggle - \$6.98



MASTER LOCK 1" STEEL LOCKOUT HASP

Lockout by multiple workers at each lockout point, control cannot be turned on until last worker's safety padlock is removed from hasp, heavy gauge steel jaw with red vinyl coated handle, 1-3/4" x 4-1/2" with 1" inside jaw diameter, holds up to (6) safety padlocks.

420 - \$5.19



MASTER LOCK ELECTRICAL LOCKOUT / TAGOUT KIT

(3) Zenex padlocks, keyed alike, (1) circuit breaker padlock, (1) lockout hasp, (1) labeled snap-on red lockout hasp, (2) Grip Tight circuit breaker lockout devices, (3) Grip Tight circuit breaker lockout devices, (1) universal wall switch lockout device, and (1) Bag (12/Pack) of lockout tags.

1457E410KA - \$151.99



STOPOUT CINCH CABLE LOCKOUT

Lockout contains internal cable spooling feature to quickly, simply and neatly extend and loop the 6' nylon-coated, steel cable through several devices to lock them out; insert the cable end back into cinch lock device for it to "cinch" tight and unmovable.

KDD630 - \$35.99



STOPOUT DISPOSABLE PADLOCK SEAL

Cost-saving, single-use lock device for operation-wide plant and facility lockout shutdown and turnaround; eliminates the hassle of misplaced locks and keys; band can only be broken or cut for removal; 10 pack.

TLS202 - \$26.99



EQUIPMENT STATUS TAGS

Identify clearly and alert staff to cautions with durable safety tags that work effectively in extreme environments. Available in three materials (5 pack or 25 pack).

TRS307 - Starting at \$3.26

SAFETY CAN COLOR CODING



GASOLINE



DIESEL



KEROSENE



OIL



JUSTRITE SURE-GRIP EX FLAMMABLE SAFETY CABINET

Designed to meet OSHA and NFPA standards, constructed of sturdy 18-gauge thick double-wall, welded steel with 1-1/2" of insulating air space for fire resistance, High-performance, self-latching doors close easily and securely; fail-safe closing mechanism, 43" width x 44" height x 18" depth, 30 gallon capacity, yellow.

893000 Yellow - \$670.99

893001 Red - \$670.99

893003 Gray - \$670.99

893005 White - \$670.99

JUSTRITE TYPE I STEEL SAFETY CAN WITH TRIGGER HANDLE

Single spout for filling and pouring, sealed lid features automatic positive-pressure relief that vents between 3 and 5 psig to guard against rupture or explosion, made from high-grade coated steel, 100% leakproof construction, tough powder-coat finish resists chemicals, equipped with a stainless steel flame arrester which dissipates heat to stop flashback ignition, certified by FM, UL/ULC, and TUV, meets OSHA and NFPA requirements, 10 year warranty, 1 gallon.

10301 Red - \$41.99



JUSTRITE TYPE I STEEL SAFETY CAN

Single spout for filling and pouring, sealed lid features automatic positive-pressure relief that vents between 3 and 5 psig, made from high-grade coated steel, 100% leakproof construction, tough powder-coat finish resists chemicals, equipped with a stainless steel flame arrester which dissipates heat to stop flashback ignition, certified by FM, UL/ULC, and TUV, meets OSHA and NFPA requirements, 10 year warranty, 5 gallon. Available in red, blue, yellow, and green.

7150100 5 gallon, Red - \$47.99

7125100 2.5 gallon, Red - \$46.99

7120100 2 gallon, Red - \$53.99

7110100 1 gallon, Red - \$39.99



JUSTRITE TYPE II ACCUFLOW STEEL SAFETY CAN WITH 5/8" METAL HOSE

Safe-Squeeze trigger for safe and controlled pouring, made from high-grade coated steel, pressure tested to ensure quality, tough powder-coat finish resists chemicals and stands up to demands of rigorous use, sealed lid features automatic positive-pressure relief that vents between 3 and 5 psig to protect against explosion, ergonomic lift lever opens the self-closing spout wide for easy filling, 10 year warranty, 5 gallon. Available in red, blue, yellow, and green.

7250120 5 gallon, Red - \$83.99

7225130 2.5 gallon, Red - \$79.99

7220120 2 gallon, Red - \$79.99

7210120 1 gallon, Red - \$74.99



JUSTRITE OILY WASTE CAN

Lid opens to no more than 60 degrees and stays closed when not in use, round construction and elevated base allow circulation of air around can to disperse heat and reduce moisture build-up, durable steel construction with a powder-coat finish, 10 year warranty, 6 gallon.

09100 Red - \$57.99

09101 Yellow - \$57.99



JUSTRITE POLYPROPYLENE FUNNEL FOR TYPE I STEEL SAFETY CANS

For use with steel Type I Justrite safety cans 1 gallon (4 liters) and above.

11202Y - \$10.99





HMD904 SPECIFICATIONS
Electrical System: 115 V, 50/60 Hz - 9 A, 1035 W 230 V, 50/60 Hz - 4.5 A, 1035 W
Motor: 8 A (115 V), 4 A (230 V) 450 RPM
Diameter: 7/16" - 1-1/2" (12 mm - 38 mm)
Depth: 2" (50 mm)
Cutter/Mount: Rotabroach, Copperhead & Fusion cutters, 3/4" (19 mm) shank
Dimensions: 7-13/16" H x 6-1/2" W x 11-11/16" L

HOUGEN VERSATILE PORTABLE MAGNETIC DRILL

Large 1-1/2" x 2" capacity, positive slug ejection, more durable and powerful magnet, many accessories are available for a portable machine shop including: drill chucks, tapping, countersink, and more; feed handles quickly change from side to side, lift detector safety system, gravity fed coolant system, carrying case included, one year warranty, precisely line up your pilot with the holes center location, one stroke lock and unlock handle, great for horizontal, overhead, tight areas, and getting out over another piece of steel.

HMD904 - \$995.00

HMD904S With swivel base - \$1125.00

BEST
ALL-AROUND



HMD130 SPECIFICATIONS
Electrical System: 115 V, 50/60 Hz - 9 A, 1035 W 230 V, 50/60 Hz - 4.5 A, 1035 W
Motor: 8 A (120 V), 4 A (240 V) 450 RPM
Diameter: 1/2"-1-3/8" (12 mm - 35 mm)
Depth: 1" (25 mm)
Cutter/Mount: RotaLoc with push and turn style shank
Dimensions: 6-11/16" H x 6-3/4" W x 14-11/16" L

HOUGEN LOW PROFILE RIGHT ANGLE DRILL

Lightweight at only 23.8 lbs, patented quill feed arbor for smooth cuts and minimal maintenance, uses RotaLoc Plus annular cutters which requires no tools for installation or removal, positive slug ejection, high torque gearing, lift detector safety system, feed handle switches easily from side to side, ratchet can be used in place of feed handle, rear mounted controls, carrying handle, carrying case included, one year warranty.

HMD130 Ultra low profile (6-11/16" height, 23.8 lbs) - \$985.00



HOUGEN ROTAMAGIC SUPER CONCENTRATED CUTTING FLUID

Water soluble, biodegrade cutting lubricant that yields a 10:1 ratio when mixed with water; extends tool life and improves cutter performance, (1) pint bottle.

11741 - \$3.25

11742 (1) gallon bottle - \$47.25



HOUGEN 1" ROTALOC PLUS ANNULAR CUTTERS (FOR HMD150)

1" depth of cut; more sizes available; use with pilot 17470.

17801 RotaLoc Plus Kit including 9/16", 11/16", 13/16" diameter plus (3) pilots and case - \$126.99

17218 9/16" / .5625" - \$36.50

17222 11/16" / .6875" - \$39.75

17226 13/16" / .8125" - \$44.80



HOUGEN 2" 12,000 SERIES ANNULAR CUTTERS (FOR HMD904)

2" depth of cut; copperhead carbide tips and more sizes available.

12214 7/16" / .4375" - \$36.19

12216 1/2" / .5000" - \$39.85

12218 9/16" / .5625" - \$45.19

12220 5/8" / .6250" - \$48.75

12222 11/16" / .6875" - \$54.05

12224 3/4" / .7500" - \$59.39

12226 13/16" / .8125" - \$62.95

12228 7/8" / .8750" - \$66.75



HOUGEN D.O.C. PILOT BITS

For 12,000 series annular cutters.

10532 2" D.O.C. for use with 7/16" - 9/16" - \$6.89

10528 2" D.O.C. for use with 5/8" and above - \$7.95

For RotaLoc Plus annular cutters

17470 1" D.O.C. for use with 7/16" and above - \$5.95



HOUGEN SLICK STICK LUBE

Softer than other stick lubricants for easy application, superior adhesion to the tool assuring thorough coverage.

11745 - \$10.59



MILWAUKEE FUEL LITHIUM-ION 2-TOOL COMBO KIT

Includes M18 Fuel 1/2" hammer drill / driver, M18 Fuel 1/4" hex impact driver, (2) M18 Redlithium XC 5.0 extended capacity battery packs, M18 & M12 multi-voltage charger, belt clip, carrying case, side handle. M18 Fuel features a power state brushless motor, Redlink Plus electronic intelligence and Redlithium battery technology, this results in longer motor life, more run time and more power. The power state brushless motor works harder and lives longer than all leading competitors, while reducing noise and cooling more rapidly.

2897-22 - \$399.00

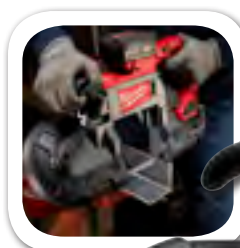

MILWAUKEE M18 FUEL DEEP CUT BAND SAW KIT

Cuts faster than its corded counterparts, provides the same legendary durability of a Milwaukee corded band saw, and delivers up to 2X more run time than other cordless options, power state brushless motor, CPT constant power technology, over 90% same parts as Milwaukee's Corded Deep Cut Band Saw, Jobsite Armor Technology, Redlink Plus, all metal direct drive, tool-free locking adjustable shoe, industry's largest cutting capacity, LED light. Includes M18 Fuel deep cut band saw kit, (2) M18 Redlithium XC 5.0 extended capacity battery pack, M18 & M12 multi-voltage charger, blade, and carrying case.

2729-22 2 batteries - \$579.00

2729-21 1 battery - \$479.00



MILWAUKEE M18 CORDLESS LITHIUM-ION 6-TOOL COMBO KIT

Includes M18 cordless lithium-ion 1/2" hammer drill/driver, Sawzall M18 cordless Lithium-ion recip saw, M18 cordless Lithium-ion 6-1/2" circular saw, M18 1/4" hex compact impact driver, M18 cordless Lithium-ion 4-1/2" cut-off / grinder, (2) M18 XC high capacity Redlithium batteries, M18 & M12 multi-voltage charger, M18 work light, contractor bag. Also available with Fuel option with Part # 2796-26.

2696-26 - \$649.00

2696-24 4-piece kit includes M18 cordless lithium-ion 1/2" hammer drill/driver, Sawzall M18 cordless Lithium-ion recip saw, M18 1/4" hex compact impact driver, batteries, charger, M18 work light, contractor bag. - \$429.00

MILWAUKEE DEEP CUT VARIABLE SPEED BAND SAW KIT

Best in class amp motor, high cut visibility, industry's largest cut capacity, 14.5 lbs, includes deep cut variable speed band saw and carrying case.

6232-21 - \$299.00



MILWAUKEE M18 LITHIUM-ION 2-TOOL COMBO KIT

Includes M18 cordless lithium-ion 1/2" hammer drill/driver, M18 1/4" hex compact impact driver, (2) M18 Redlithium XC extended capacity batteries, M18 & M12 multi-voltage charger, and contractor bag.

2697-22 - \$299.00



MILWAUKEE 40 PIECE SHOCKWAVE DRILL & DRIVE BIT SET

Includes (4) hex bits, (10) Phillips bits, (3) slotted bits, (6) square bits, (7) Torx bits, (1) 1/2" socket adapter, (1) 1/4" magnetic nut driver, (1) 1/4" Shockwave hex drive bit, (1) 1/8" drill bit, (1) 3/16" Shockwave hex drive bit, (1) 3/8" magnetic nut driver, (1) 3/8" socket adapter, (1) 5/16" magnetic nut driver, and (1) Shockwave compact magnetic bit holder.

48-32-4006 - \$27.99



MILWAUKEE 29 PIECE THUNDERBOLT BLACK OXIDE DRILL BIT SET

Includes 11/32", 1/16", 11/64", 1/2", 13/32", 13/64", 1/4", 15/32", 15/64", 17/64", 1/8", 19/64", 21/64", 23/64", 25/64", 27/64", 29/64", 3/16", 31/64", 3/32", 3/8", 5/16", 5/32", 5/64", 7/16", 7/32", 7/64", 9/32", 9/64".

48-89-2802 - \$59.99





MILWAUKEE M18 JOBSITE RADIO

7.70" length x 15.80" width x 7.75" height; 10.34 lbs; high performance audio system with dual speakers and passive radiators delivers loud, clear sound with deep accurate bass; durable design protects from drops and other harmful job site conditions and features a weather sealed auxiliary compartment; digital AM/FM tuner with 10 station presets; USB charger for electronic devices; powered by all M18 batteries or AC outlet (battery not included); up to 12 hours run time with M18 battery.

2890-20 - \$119.00



MILWAUKEE M18 WET / DRY VACUUM

Works on all Milwaukee 18 V slide-on Redlithium or NiCd batteries, powerful motor to provide strong suction and air flow, tool box style for easy transport and storage, on-board accessory and hose storage, HEPA filter, and built-in blower port, ideal for both wet and dry applications.

0880-20 - \$99.00



MILWAUKEE 6 PIECE SCREWDRIVER SET

Includes 3" cabinet 3/16" screwdriver, 3" Phillips #1 screwdriver, 4" Phillips #2 screwdriver, 4" slotted 1/4" steel cap screwdriver, 6" cabinet 3/16" screwdriver, 6" slotted 5/16" steel cap screwdriver.

48-22-2006 - \$34.99



MILWAUKEE 6 IN 1 COMBINATION PLIERS

Revolutionary dual head design for wire stripping and needle nose functionality, reaming head to smooth out rough edges of metal pipe.

48-22-3069 - \$33.99



MILWAUKEE FASTBACK SPRING ASSISTED SERRATED KNIFE

Spring-assisted opening for one-handed operation, black oxide-coated stainless steel serrated blade to cut through tough materials, secures the blade in the open position with liner lock, small and compact to store easily yet withstands job site abuse, reversible wire-form belt clip.

48-22-1995 - \$24.00



MILWAUKEE FASTBACK FLIP UTILITY KNIFE WITH STORAGE

Features magnetic blade storage, press-and-flip operation for one-handed opening, tool-free blade change, durable all-metal body, gut hook, wire stripper, and wire-form belt clip. Includes Fastback II flip utility knife with storage, (2) utility knife blades.

48-22-1903 - \$14.99

48-22-1901 Without storage - \$12.99



MILWAUKEE INKZALL BLACK FINE POINT MARKER

Inkzall Jobsite Markers feature clog resistant tips and the ability to write through dusty, rough, wet or oily surfaces. Ink dries quickly to reduce smearing markings, without drying out quickly when the cap is left off. Built-in hard hat clip for easy storage and access.

48-22-3104 4 Markers - \$4.60

48-22-3100 1 Marker - \$1.25

Milwaukee

GME
Supply Co

TOOLS // MILWAUKEE



MILWAUKEE 9-PIECE SHOCKWAVE 1/2" DRIVE THIN WALL DEEP IMPACT SOCKET SET

Chromoly steel and custom heat treatment for maximum durability, drives on flats to reduce stripping and breakage, thin wall construction for impact strength in tight clearance applications; Shockwave impact sockets included: 3/8", 7/16", 1/2", 9/16", 5/8", 11/16", 3/4", 7/8"; also includes 1/4" hex to 1/2" square adapter.

49-66-4484 - \$75.49



MILWAUKEE SAWZALL M18 FUEL RECIP SAW KIT

Includes Fuel Sawzall recip saw, (2) M18 Redlithium XC 4.0 extended capacity battery pack, M18 & M12 multi-voltage charger, blade, and carrying case.

2720-22 - \$399.00

MILWAUKEE 9 PIECE SAWZALL BLADE SET

Includes New wood blades featuring nail guard and fang tip and durable storage case. Nail guard combines an aggressive 5 TPI pattern for faster cutting, with a unique design that protects against tooth fractures. The fang tip design bites into wood on first contact for faster plunging. Jobsite durable storage case adjusts to hold up to 9" blades.

49-22-1145 - \$19.99



MILWAUKEE SHOCKWAVE 1/4" HEX TO 3/8" SQUARE SOCKET ADAPTER

Proprietary steel and heat treat process for maximum strength and durability, and heavy duty construction for fastening capabilities in all impacts.

48-32-5031 - \$4.99



MILWAUKEE SHOCKWAVE 1/4" HEX TO 1/2" SQUARE SOCKET ADAPTER

Proprietary steel and heat treat process for maximum strength and durability, and heavy duty construction for fastening capabilities in all impacts.

48-32-5032- \$6.79



MILWAUKEE 9" 18 TPI "THE TORCH" SAWZALL BLADES (5 PACK)

Grid Iron honeycomb pattern increases blade rigidity to resist blade buckling, tough neck ribs strengthen the blade tang and minimize breakage.

48-00-5788 9" - \$19.99

48-00-5784 6" - \$19.99



MILWAUKEE M18 CORDLESS LITHIUM-ION 4-1/2" CUT-OFF / GRINDER KIT

Includes M18 Cordless Lithium-ion 4-1/2" cut-off / grinder, M18 XC high capacity Redlithium battery, M18 & M12 multi-voltage charger, contractor bag, side handle.

2680-22 - \$349.00



MILWAUKEE CUT-OFF WHEEL

4-1/2" x .045" x 7/8; A60T Type 27 comprehensive offering for general purpose to specialized high performance applications; consistent performance from wheel to wheel through superior manufacturing processes; tested for balance, resulting in smooth, vibration free grinding and cutting.

49-94-4505 - \$2.49



MILWAUKEE DUAL TEMPERATURE HEAT GUN

1.8 lb heat gun offers 570 degree and 1,000 degree temperature ranges, stay cool handles and heat shields, unique impact resistant heating element, three position rocker switch - off, high and low.

8975-6 - \$114.00



MILWAUKEE M18 FUEL 1/2" HIGH TORQUE IMPACT WRENCH WITH PIN DETENT KIT

Includes M18 Fuel 1/2" high torque impact wrench with pin detent, (2) M18 Redlithium XC 5.0 extended capacity battery packs, M18 & M12 multi-voltage charger, carrying case.

2762-22 - \$429.00

(800) 940-6762

175

KLEIN TOOLS

KLEIN ERECTION WRENCH

Forged from select alloy steel to withstand high-leverage and heavy loads, extra-heavy duty head area gives maximum strength and durability, continuous taper of handle makes lining-up bolt holes easy and works on a range of bolt and/or hole sizes without binding, extra-large hub area works on larger diameter holes than other wrenches.

- 3219 1/2" regular nut - \$33.99
- 3221 5/8" regular nut - \$35.99
- 3222 3/4" regular nut - \$40.99
- 3223 7/8" regular nut - \$51.99
- 3224 1" regular nut - \$57.99
- 3210 1/2" heavy nut - \$33.99
- 3211 5/8" heavy nut - \$35.99
- 3212 3/4" heavy nut - \$40.99
- 3213 7/8" heavy nut - \$51.99
- 3214 1" heavy nut - \$57.99
- 3212TT 3/4" heavy nut with tether hole - \$41.99
- 3213TT 7/8" heavy nut with tether hole - \$50.99
- 3214TT 1" heavy nut with tether hole - \$57.99



KLEIN TOOLS ADJUSTABLE SPUD WRENCH

Eliminates the need for carrying several fixed-size wrenches; tether hole for tool tether connection; corrosion resistant, 16" length, fits all nuts and bolts to 1-1/2".

- 3239 - \$75.99
- 3227 10", fits up to 1-5/16" - \$47.99

KLEIN TOOLS 1/2" DRIVE RATCHETING CONSTRUCTION WRENCH

Accepts 1/2" square-drive hex socket, reversible ratchet, industrial black finish for corrosion resistance.

- 3238 - \$79.99

KLEIN TOOLS BROAD-HEAD BULL PIN

1-1/4" top diameter, 13-3/4" length.

- 3255 - \$23.99
- 3246TT Round - \$71.99
- 3243 Hex - \$80.42

KLEIN TOOLS CONNECTING BAR WITH TETHER HOLE

7/8" diameter, 36" length.

- 3256 1-1/16" top diameter, 10" length - \$22.99
- 3255TT 1-1/4" top diameter, 13-3/4" length with tether - \$27.99
- 3256TT 1-1/16" top diameter, 10" length with tether hole - \$25.99



KLEIN TOOLS ERECTION WRENCH HOLDER

Leather construction for long life, tool-slots for two erection wrenches, holds Erection Wrenches and the Adjustable Head Construction Wrench (Cat. No. 3239).

- 5460 - \$17.39



KLEIN TOOLS ERECTION WRENCH HOLDER

Riveted leather construction for long life, slots for two erection wrenches, and holds erection wrenches and adjustable head construction wrench Cat. No. 3239.

- 5459T - \$18.99



KLEIN TOOLS CONNECTING BAR HOLDER WITH LOCK COLLAR

Made of leather, designed for use with Klein Tools 7/8" round connecting bars (Cat. Nos. 3248 and 3246), tunnel loop allows for weight distribution on belt, and fits belts up to 3-1/2" wide.

- 5459SLVR - \$19.99





KLEIN TOOLS BARREL-TYPE DRIFT PIN

Machined from quality alloy steel, tapers are uniform and blend into body diameter, 8" length, 13/16" max diameter.

3261 - \$6.99

3262 15/16" max diameter - \$7.99

KLEIN TOOLS STANDARD BULL PIN

1-3/16" top diameter, 15" length.

3252 - \$16.15

3259 1-5/16" top diameter, 12" length - \$20.99

3259TT 1-5/16" top diameter, 12" length with tether - \$32.99

3259TTS 1-5/16" top diameter, 12" length, stainless steel with tether hole - \$88.99



KLEIN TOOLS SLIM REBAR WORK PLIERS

9" length. Twists and cuts soft annealed rebar tie wire. Includes split ring for tethering when working at height. Spring loaded action for self opening. Induction hardened cutting knives. Heavy duty knurled jaws. Unique handle tempering helps absorb the "snap" when cutting wire. Hook bend handle.

D201-7CSTT With tether ring - \$67.99

D201-7CST Without tether ring - \$56.99

KLEIN TOOLS DIAGONAL CUTTING PLIERS FOR REBAR WORK

9" length. Includes split ring for tethering plier while working at height. High leverage design for greater cutting and gripping power. Induction hardened cutting knives.

D248-9STT With tether ring - \$47.99

D248-9ST Without tether ring - \$38.99

KLEIN TOOLS PUMP PLIERS

Quick-adjust rivet allows one-handed fast, easy adjustment. Includes split ring for tethering plier while working at height. 7/8" maximum parallel jaw opening for a range of applications. Smoothly adjusts between five machined tongue and groove jaw positions. Robust teeth for sure gripping action. Induction hardened jaws.

D502-6TT 6-1/2" length - \$34.99

D502-10TT 10" length - \$41.99

D502-12TT 12" length - \$48.99



SCOTCH 35 VINYL COLOR CODING ELECTRICAL TAPE

7-mil thick polyvinyl chloride (PVC) color-coding tape, outstanding electrical and mechanical properties make this tape excellent for use in phase identification, color coding of motor leads and piping systems. Available in white, red, blue, green, yellow, orange, brown, gray, and violet; 66'.

35 - \$4.69



TEMFLEX GENERAL USE VINYL 1700 ELECTRICAL TAPE

Good quality, economical general purpose vinyl insulating tape; has excellent resistance to abrasion, moisture, alkalies, acid, copper corrosion and varying weather conditions, 66'.

1700 - \$0.99



SCOTCH SUPER 33+ VINYL ELECTRICAL TAPE

Quality, general-purpose vinyl insulating tape with excellent resistance to: abrasion, moisture, alkalies, acid, copper corrosion and varying weather conditions, 66'.

33+ - \$4.95





CRESCENT TOOLS 2-PIECE ADJUSTABLE WRENCH SET

Includes an 8" and 12" adjustable wrench, each wrench has a hex jaw design with an extra wide grip for comfort, made of alloy steel and topped off with a chrome finish, opening sizes of 1-1/8" and 1-1/2", laser etched scale, wider knurl, handle is 70% and jaws open 25% wider than conventional wrenches.

AC2812VS - \$40.99



WISS HI-VIS MULTIMASTER LONG CUT AVIATION SNIPS

Blade design for straight cuts, non-slip grips, great for making long, fast cuts in several types of material including paper, plastic, sheet metal, aluminum, vinyl siding, screening, and much more; hi-visibility, non-slip, rubber grips on handle and serrated jaws, 10-1/2" long with 3" cut, twice as long as standard snips.

M300 - \$18.99



RIDGID 12" PROHACK HACK SAW

Superior strength and maximum control in a lightweight professional hack saw, casting provides both greater strength and improved access, blade replacement is easy with the large tensioning knob and the rubberized hand grips fore and aft ensure a controlled and speedy cut, provides (2) positions for mounting the blade: 45 or 90 degree.

20238 - \$22.99



KLEIN TOOLS RATCHETING CABLE CUTTER

High leverage ratchet mechanism for single-handed cutting of copper and aluminum cables, leaving no burrs or sharp edges. Patented two-step ratchet mechanism requires fewer strokes per cut. Quick release opens blades easily. Hardened steel cutting blades for lasting strength and sharpness. Locking lever keeps handles closed for easy transport.

63750 - \$354.99



KLEIN TOOLS CABLE CUTTER

Lightweight, replaceable hook-jaw blades grab and hold cable while shear-cutting action makes clean cuts, heavy-duty pins in head serve as blade-stops, jaws are forged tool steel with black-oxide finish for long life, 25.5"

63041 - \$135.99

63045 32" - \$155.99



ANCHOR BOLT CUTTER

Has a compound action blade made from hardened and tempered forged alloy steel; 18" length, straight cutting direction, center cut type, forged alloy steel jaw material

39-018 - \$16.99



CRESCENT TOOLS 5-PIECE LOCKING JAW PLIER SET

Crescent locking pliers are made to a standard that results in long-term performance and durability; this set includes (3) curved jaw locking pliers (5", 7", and 10"), and (2) long nose locking pliers (6" and 9"); each plier features a patented angled tooth pattern for a better grip and an integrated wire cutter, nickel plated to resist rust and corrosion, non-slip locking grip.

CLP5SET - \$34.99



IRWIN INDUSTRIAL TOOLS 30-PIECE FASTENER DRIVE TOOL SET

Includes most popular insert bits, double ended bits, and nut setters; (4) magnetic nut setters in most popular sizes, (21) contractor grade insert bits and (4) double-end power bits, powerful magnetic bit case with rubberized grip and sliding latch, (30) piece driving set for secure hardware attachments.

357030 - \$24.99



SEE BAGS WITH CONNECTION POINTS ON PAGE 114



SQUIDS TRIPLE-LOCKING CARABINER

Stretch cord surrounded by tubular nylon webbing, lock stitching at both ends, heavy-duty (8 kN) triple-locking carabiner, 360° swivel captive-eye, adjustable barrel lock for tool attachment, holds up to 15 lbs, 35" - 42".

3109 35" to 42" - \$32.99

3109EXT 42" to 54" - \$33.99



SQUIDS LOCKING CARABINER

Stretch cord surrounded by tubular nylon webbing, lock stitching at both ends, heavy-duty (500 KGF) self-locking carabiner, adjustable barrel lock for tool attachment, holds up to 10 lbs, 28" - 35".

3108 - \$20.99



SQUIDS STAINLESS STEEL CARABINER

Stretch cord surrounded by tubular nylon webbing, lock stitching at both ends, stainless steel carabiners for corrosion resistance, screw gate on carabiner for locking connection, holds up to 15 lbs, 35" - 42".

3101 - \$13.99

3101EXT 42" to 54" - \$20.99



SQUIDS WRIST TOOL LANYARD

Holds up to 5 lbs, polyester webbing cuff secures to wrist, ribbed pull cord.

3115SM S/M 5-7" wrist - \$2.99

3115LXL L/XL 7-9" wrist - \$2.99



SQUIDS TOOL LANYARD

Holds up to 10 lbs, aluminum carabiner, adjustable barrel lock, 35" to 42", lime or black.

3100 35" to 42" - \$9.99

3100EXT 42" to 54" - \$9.59



SQUIDS DUAL CARABINER TOOL LANYARD

Holds up to 10 lbs, aluminum carabiner on each end, 35" to 42", lime or black.

3110 35" to 42" - \$9.99

3110EXT 42" to 54" - \$10.99



SQUIDS DETACHABLE WITH CARABINER

Holds up to 5 lbs, aluminum carabiner, quick-connect buckle, 35" to 42".

3102 - \$8.99



SQUIDS DETACHABLE LOOPS

Includes (3) elastic loops that attaches to 3102 for quick exchanges of multiple tools.

3103 - \$4.19



SQUIDS ELASTIC LOOP TOOL TAILS

Retrofit attachment points, can also be used on belt or harness, pack of (3), 15 lb max, 11".

- 3703 - \$9.99
- 3703EXT 15 lb max, 18" - \$11.49
- 3713 10 lb max, 11" - \$12.49



SQUIDS TOOL SHACKLE

Stainless steel shackles connect to tools with tapered mid sections or tools with captive holes, creating clean, secure attachment points for tethering. 15 lb capacity. 2 Pack.

- 3790S S - \$8.99
- 3790M M - \$9.99
- 3790L L - \$10.99
- 3790XL XL - \$12.99



SQUIDS COLD SHRINK TRAP

Requires no heat source, no additional tools needed for attachment, uses no adhesives, can be removed and replaced without a mess, EPDM rubber material resists acids, alkalies, and extreme temps, for tools ranging from .75" to 2.5" in diameter; 3" length, 5 lb capacity.

- 3723 3" length, 5 lb capacity - \$8.65
- 3724 4" length, 10 lb capacity - \$10.35
- 3726 6" length, 15 lb capacity - \$14.95



3700 SQUIDS WEB TOOL TAILS 6-PACK

Web tool tails provide retrofit attachment points to a variety of tools and equipment up to 2 lbs using Squids Tool Traps.

- 3.5" Black - \$7.15
- 4.5" Orange - \$7.15
- 5.5" Black - \$7.15
- 6.5" Orange - \$7.15
- 8.5" Black - \$7.15
- Variety 5-Pack Orange/Black - \$7.15



SQUIDS HEAT TAPE TRAP

Captures Squids Tool Tails securing a safe connection to tools like no other tool attachment tape, quickly wraps on a variety of hand tools, power tools, and other equipment, leaves no residue. 15 lb capacity.

- 3750 12' roll - \$16.99
- 30' roll - \$38.99



SQUIDS RETRACTABLE LANYARD

Stainless steel carabiners, lanyard will lock into place at a desired length of up to 48" to secure your tools and prevent tangling, technora cord, modular quick connecting buckle. Maximum capacity: 1 lb.

- 3000 - \$29.99
- 3001 Elastic Loop style - \$26.99

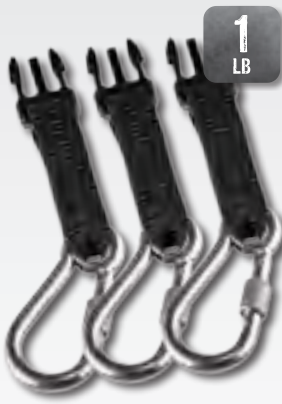

SQUIDS RETRACTABLE ACCESSORY 3-PACK

Includes 3 stainless steel carabiners that attach to retractable lanyards for quick exchange of multiple tools, modular quick connecting buckle. Maximum capacity: 1 lb.

- 3025 - \$21.65
- 3026 Elastic Loops - \$9.99



SQUIDS TAPE MEASURE TRAP

Tape measure trap securely wraps around most popular standard tape measures, D-ring connection point attaches to lanyard to prevent drops, 1,200 D and 600 D polyester main material, iron belt clip. Maximum capacity: 2 lbs.

- 3770 - \$14.99



DBI SALA HOOK2LOOP BUNGEE TETHER

Built from custom abrasion-resistant webbing for durability and longevity, features a twist-locking carabiner, 31" - 52".

1500049 - \$29.99



DBI SALA HOOK2HOOK COIL TETHER

Made from vinyl-coated braided steel coil, self-locking aluminum carabiners, relaxed length of 5" and stretched length of 62", this tool lanyard is designed to stay out of the way when not in use.

1500063 - \$16.99



DBI SALA HOOK2LOOP BUNGEE TETHER

Versatile extension for use with any tool under 10 lbs., locking carabiner and choker loop, 5/8" tubular webbing, 32" to 47".

1500047 - \$14.99



SQUIDS POWER TOOL TRAP

Wraps around the battery portion of drills, impact drivers, and other cordless power tools, D-ring connection points attaches to a lanyard to prevent drops, two hook and loop straps secure trap to power tool battery, 1,000 D nylon construction. Max capacity: 6 lbs

3780 - \$13.35

S fits batteries up to 3.5"L x 2.75"W x 2.5"H - \$13.35

L fits batteries up to 5"L x 3.5"W x 3.5"H - \$14.95



T-REIGN 902 SERIES HEAVY DUTY RETRACTABLE TETHER LANYARD

Rugged 48" Kevlar cord; includes a lock that takes tension off the tether, allowing the cord to remain extended; rugged polycarbonate case, weather-proof materials safe to use in any environment, carabiner connector.

OTRG-241 - \$24.99



T-REIGN PROHOLSTER POUCH

Open-top protective case with a retractable tether, designed for two-way radios, GPS devices or small cameras that need some protection, but are ruggedly built and need to be within easy reach; rugged, 36" Kevlar tether is strong and durable, preventing drops or loss of gear; patent-pending hook and latch closure system allows quiet, one-handed access to gear; constructed with rugged 600 denier nylon, tether cord can stretch to accommodate up to a 6" tall device, 2" wide x 1.1" deep.

908471 - \$29.99



JOHNSON BIG J STAINLESS STEEL CASE POWER TAPE

Extra wide 1-3/16" Big J blade for maximum extension, blade-guard nylon coated blade resists abrasion, double duty 2-sided printed 2-color blade, impact resistant ergonomic co-molded rubberized and stainless steel case, (4)rivet self-adjusting blade plate and extra wide flared tip with 2-sided hook.

1807-0025 - \$14.99



JOHNSON JOB SITE OPEN REEL FIBERGLASS TAPE MEASURE

Durable steel end hook with loop, 2-color blade: white inch scale, yellow engineer's scale, comfortable non-slip rubberized hand grip, rugged, high impact ABS Case.

1808-0100 100' - \$14.99

1808-0300 300' - \$40.99



KLEIN TOOLS FISH TAPE

Permanent, laser etched 1" increments, polypropylene case/handle, raised finger grips, 1/8".

56002 65' - \$35.99

56003 125' - \$50.99

56004 240' - \$70.99



LUFKIN AUTO-LOCK 25' TAPE MEASURE

1" wide blade length, automatic blade lock holds the blade in extended position, recessed lock release to reduce chance of accidental retraction, non-slip co-molded rubber grip, durable clear coat blade protection for longer blade life, steel reinforced end hook for longer service life.

182-AL725 - \$9.99



JOHNSON MAGNETIC ALUMINUM REINFORCED TORPEDO LEVEL

Aluminum reinforced frame, rubber magnetic working edge allows for hands-free use on ferrous metal surfaces, V-groove frame fits on pipe and conduit, tapered ends assure an easy fit into tool belts, tool pouches or work pant pockets, surround view vials reflect ambient light for easy-read, oversized frame, Multi-Pitch vial reads slope in 1/8" increments.

1401-0900 9" length - \$9.99

1401-1200 12" length - \$11.99



JOHNSON DIGITAL BOX LEVEL WITH ROTATING DISPLAY & GLOW VIEW REG TECHNOLOGY

Surround view vials reflect ambient light for easy-read, Quick horizontal and vertical calibration, automatic digit inversion for overhead measurements, hold function locks measurement on LCD, extremely accurate with 0.05° at 0° and 90°, angle inclination in 5 construction languages - units of measure (degrees, percent, in/ft (fractional), in/ft (decimal, mm/m), working range on angle measurement 4 x 90°, IP 65 dust and waterproof.

1880-2400 24" length - \$164.99

1880-4800 48" length - \$194.99



JOHNSON MAGNETIC TORPEDO LASER LEVEL

(3) vials read plumb, level, and cross check; projects laser dot, horizontal and vertical lines for versatile use; interior range up to 100', accurate to +/- 3/8" at 50' for great precision, durable molded housing is impact resistant, magnetic edge holds the tool securely to non-ferrous metals, includes (2) "AAA" batteries.

40-0915 - \$19.99



JOHNSON MAGNETIC DIGITAL LEVEL

5 units of measure (degrees, percent, mm/m, in/ft in decimal, in/ft in fractional), automatic digit inversion for overhead measurements, backlight for easy-read in dimly lit work environment, powerful grip tight rare earth magnets hold to ferrous metal surfaces, push button calibration, audible indicator at 0° and 90°. Includes (3) "AAA" alkaline batteries, instruction manual, and soft-sided pouch.

40-6060 - \$130.00



STANLEY 48" TOP READ ALUMINUM LEVEL

An ideal lightweight, professional grade aluminum level for construction use; top-read center vial designed for easy readability, yellow vial covers for high visibility and easier reading vials, shock-absorbing end caps hold up to heavy use and prevent denting, hang hole simplifies storage, limited lifetime warranty.

680-42-076 - \$13.99

**TIMES
MICROWAVE
LMR300 & 400
CRIMP TOOL
.324" & .429"**

Ratcheting crimper for LMR300 and LMR400 cables with corresponding crimp-style connectors has a fixed die set, the die set has 2-cavities, crimping to 0.324 and 0.429 inch hex; rated at 50,000 cycles, yellow handles make this cable crimping tool easy to locate.
CT-400/300 - \$124.99



**ECLIPSE
RATCHETED
MODULAR
PLUG
CRIMPER**

Ratcheted modular plug crimper for crimping RJ11, RJ12, RJ45 modular plugs; cuts and strips silver satin flat telecom cable, cuts and strips CAT5/6 UTP cable.
902-360 - \$14.99



**THOMAS &
BETTS COLOR-
KEYED MANUAL
CRIMP TOOL**

Color-Keyed compression tool, comfort crimp ergonomic design, shure-stake ratchet, rotating die wheel, color-coded die nests, die code embossment, works on #8-#2 copper and #10-#6 aluminum lugs and splices, also for green 54705-54727 C-taps and MD2.
TBM45S - \$265.99



**GREENLEE
CRIMPING
TOOL 8-1
AWG**

Small size and light weight make this an ideal tool for crimping small lugs and splices, easily fits in tool pouches, full-cycle mechanism assures that crimps are complete, jaws can be opened in mid-cycle if necessary to adjust connector, wide grips make crimping easy on the hands.
K111 - \$304.99



**WEATHERFLOW
WIND METER**

WeatherFlow's Wind Meter is small enough to fit in your pocket, and works with your smartphone to collect real time wind, temperature, humidity, and pressure readings. This handheld anemometer is compatible with your iPhone, iPad, iPod and Android devices. With corresponding app, plug the wind meter into your device's audio jack and measure wind speed, direction, and location. Measures wind speed (avg., gust., apparent, true), wind direction (magnetic and true), crosswind and headwind/tailwind; operating range: 2 mph - 125 mph; accuracy: +/- 0.5%; Plugs into 3.5 mm smartphone audio jack.
WFANO-01A-MC Wind Meter - \$39.99
WFANO-02 Weather Meter - \$79.95



**KESTREL 3000
WEATHER
METER**

Rugged anemometer, measures air/water/snow temperature, wind chill, current/average/maximum wind speeds, impeller-mounted in a high-performance polyamide for strength and durability, low startup speed and precise wind readings, protective over molded case, replaceable impeller, large backlit LCD, waterproof, drop tested, accurate NIST-Traceable measurements, includes replaceable CR2032 coin cell battery, lanyard; made in USA, includes 5 year warranty.
0830 - \$199.99



**COMMSCOPE
1-1/4" TORQUE
WRENCH FOR
7/16 DIN
CONNECTOR HEX
COUPLING NUT**

ANDREW 1-1/4" torque wrench for 7-16 DIN coupling nut, designed with a mechanism to audibly notify the installer that proper torque has been reached.
244377 - \$94.99



**COMMSCOPE
TORQUE WRENCH
FOR 7/8" EZFIT
CONNECTORS
1" OPENING**

ANDREW torque wrench for 7/8" 780 EZfit connectors, for use with FXL-780 and AVA5 cable, audible click when torque has been reached.
TW-78-EZFC - \$97.99



**COMMSCOPE
TORQUE WRENCH
FOR COUPLING
TORQUE
OF TYPE-N
CONNECTORS
13/16" OPENING**

ANDREW 13/16" torque wrench for Type-N coupling nut for Andrew Cable, audible click when the proper torque has been reached.
244379 - \$83.25



**JMA TORQUE
WRENCH 7/8"
8 FT LB, DIN
CONNECTOR**

PPC click-style torque wrench for Andrew 7-18 DIN coupling nut, pre-set to 8' lb. OAL is 11-1/4" blue handle.
315460 - \$220.00





PETRILLA 8 PIECE LOW PIM ADAPTER KIT

This kit includes the following adapters, which can also be purchased individually: DIN Female to N Female; DIN Male to N Female; DIN Male to N Male; DIN Female to N Male; DIN Female to DIN Female; DIN Male to DIN Male; N Female to N Female; N Male to N Male.

PET-ADPKIT-DN - \$499.99



COMMSCOPE TELETILT BOTTOM SMART BIAS TEE

Injects AISG power and control signals onto a coaxial cable line, reduces cable and site lease costs by eliminating the need for AISG home run cables, AISG 1.1 and 2.0 compliant, operates at 10-30 VDC.

ATSBT-BOTTOM-FM-4G - \$462.99



COMMSCOPE WAVEGUIDE FLARING TOOL KIT

Made for use with Helix EWP63S, EWP63, and EW63 elliptical waveguide cable, produces consistently accurate waveguide flares for connector and splice attachments, includes major-axis flaring tool, minor-axis flaring tool, and a rugged carrying case.

EWFTK-63 - \$1,132.00



COMMSCOPE EASIAX PLUS CABLE PREPARATION TOOL FOR 1-5/8\"/>

Automated cable preparation tool, prepares cable for connector attachment, includes (2) cutting blades and jacket blades, cutting blade life of (150) cable preparations.

CPT-158U For 1-5/8\"/>

CPT-78U For 7/8\"/>

CPT-12U For 1/2\"/>



COMMSCOPE 7/8\"/>

Automated cable preparation tool, prepares cable for connector attachment, includes (2) cutting blades, cutting tool body, FXL-780 cutting bit, and hex wrench.

780-EZPT - \$356.99



COMMSCOPE 1-1/4\"/>

Automated cable preparation tool, prepares cable for connector attachment, includes cutting tool body, FXL-1480 cutting bit, FXL-1480 flaring bit, and hex wrench, for 1-1/4\"/>

1480-PT - \$364.99



COMMSCOPE 1/2\"/>

Automated cable preparation tool, prepares cable for connector attachment, includes (2) combination blades, cutting blade life of (150) cable preparations.

CPT-F4B - \$123.99



TIMES MICROWAVE LMR-195 & LMR-200 CABLE PREP TOOL

All-in-one strip tool, combination allows for prep of crimp or clamp connectors, built-in debur tool.

CST-195-200 - \$99.95



TIMES MICROWAVE LMR-240 PREP TOOL FOR VIRTUALLY ALL CONNECTORS

All-in-one combination prep tool for prep of LMR240 cables for crimp or clamp connectors.

CST-240A - \$110.00



TIMES MICROWAVE LMR-400 PREP TOOL FOR VIRTUALLY ALL CONNECTORS

Made for use with 3/8 inch LMR-400 coaxial cable using crimp and clamp-style connectors; this cable hand prep tool joins a cable stripper tool and a cable trimming tool into one easy-to-use device.

CST-400 - \$98.99



JMA WIRELESS HALF TOOL KIT

The JMA Wireless Complete Compression Tool Kit is for 1/2" CC connectors. Kit Includes: 1/2" Frame set, (2) Inserts, (2) Batteries, Battery Charger, Gator Crimp frames, cable cutters, cable prep tools (SP-1/2-LDF4D, SP-12S), case, TQ-114-F18 DIN torque wrench.

KIT-CC-HALF - \$4,090.00



JMA WIRELESS COMPLETE TOOL KIT

The JMA Wireless Complete Compression Tool Kit is for 1/2", 7/8", and 1-5/8" CC connectors. Kit Includes: (3) Frame sets, (2) Inserts, (2) Batteries, Battery Charger, Gator Crimp frames, cable cutters, cable prep tools (SP-1/2-LDF4D, SP-12S, SP-78, SP-158), case, TQ-114-F18 DIN torque wrench.

KIT-CC-FULL - \$5,799.99



3M SLIM LOCK CLOSURE 716

Protects RF connections at the antenna and remote radio units. Displaces air around the cable and connector. Clamshell-like design of the closure allows re-entry, enabling repeated use of the closure. 1/2" jumper coax cable with DIN 716 connections. Used with cables with 0.53" - 0.63" in diameter. RoHS 2011/65/EU compliant.

3M-SLC-716 - \$24.99



KATHREIN USA INC. PORTABLE CONTROL ADAPTER

SCALA Portable Control adapter, (1) 8 pin connector according to IEC 60130-9, female, conforms to AISG; includes PCA, external power supply, USB cable, AC power cable, CD-ROM (with PCA software, drivers, and manual), installation guide, and carrying case.

860-10046 - \$550.00



COMMSCOPE CONTROL UNIT INTERFACE ADAPTER KIT

Carried from site to site for RET antenna setup and optimization, supports up to 32 RET actuators operating in a mix of AISG modes, LED display indicates the presence of input power, output power, and data communication, equipped with USB and serial connectors, power supply efficiency is Energy Star Level IV rated.

ATC200-LITE-USB - \$585.00



COMMSCOPE RET-MASTER

Portable battery operated controller; wireless interface between a smartphone or tablet and remote electrical down tilt devices for setup, optimization, and troubleshooting; control via Wi-Fi connection between RET master and portable devices; USB connector.

RET-MASTER - \$2,895.00



COMMSCOPE ALUMINUM PREP TOOL FOR FSJ4-50B COAX

Grounding kit preparation tool prepares cable for grounding kit attachment, 150 cable preparations cutting blade life, (1) cutting blade included, 8.7" x 2.5" x 2.2", 1.08 lb.

302977 - \$139.46



COMMSCOPE 1/2" & 7/8" COMBO TOOL FOR EZFIT CONNECTORS

Combination tool aids in field installation of connectors, rugged steel construction, for use with 1/2 inch and 7/8 inch connectors, wrench opening: 20 mm, 17 mm, 34 mm; 2.6" x 9.4", 1.03 lb.

372829 - \$70.35



ODM TTK 650 COMPLETE INSPECTION & SINGLE MODE TEST KIT

USB connectivity to included 8" tablet allows for automated and manual fiber end face inspection. Comprehensive pass/fail analysis compliant with IEC 61300-3-35 industry standard. Optical power meter with archiving ability and live-streaming data to tablet or laptop via USB. Included laser light source provides standard wavelengths for testing loss in single mode systems. Red laser allows observation of bends and breaks in fibers under test. Includes all patchcords and adapters necessary, cleaning tools and closeout report software.

TTK 650 - \$3,895.00



ODM TTK 720 FULL SINGLE MODE FTTA TEST KIT

VIS 300C-PM-02-V test platform provides full control over all parameters for fiber end-face inspection, insertion loss, and visual fault location tests. HD inspection scope with interchangeable inspection tips, analysis button, and ODM's unique external focus mechanism. Optical power meter with Germanium detector provides insertion loss (dB) and power level (dBm) results in simple pass/fail format. 635 nm red laser VFL for identification of excessive bends and breaks in SM fiber. Includes all patchcords and adapters necessary, cleaning tools and closeout report software.

TTK 720 - \$3,695.00



ODM TTK 500 GENERAL TEST & INSPECTION KIT

USB connectivity allows simple plug-and-play image saving for closeout reports. Comprehensive pass/fail analysis compliant with IEC 61300-3-35 industry standard. Optical power meter with archiving ability and live-streaming data via USB. Two included light sources provide standard wavelengths for testing loss in single mode and multi mode systems. Includes all patchcords and adapters for SC and LC connector systems, cleaning tools, closeout Report Software.

TTK 500 - \$3,595.00



ODM OTR 700 OPTICAL TIME DOMAIN REFLECTOMETER CONTRACTOR MODEL

850/1300/1310/1550 nm long range single mode and multi mode. Event table with pass/fail analysis. Bi-directional averaging - unit performs all necessary calculations automatically. Short event dead zone - ideal for short-link installations. Bluetooth-compatible for precision control with Android smartphones and tablets. Schematic view of fiber link for quick and simple trace analysis.

OTR 700-Q - \$5,895.00

ACCESSORIES

CLEANING TOOLS



TEST JUMPERS & BULK HEADS



INSPECTION TIPS & OTHER ADAPTERS





WILTON BASH SLEDGE HAMMER

Unbreakable technology steel core eliminates breaking during overstrikes, hi-vis drop forged 46 HRC steel head endures the most demanding applications, safety plate secures head to handle preventing head dislodging, ergonomic handle shaped and thickened for improved comfort and less vibration, no-slip grip, lanyard hole. More options available.

PART	HEAD	HANDLE	PRICE
20212	2-1/2 lbs	12"	\$42.99
20412	4 lbs	12"	\$48.99
20416	4 lbs	16"	\$57.99
20616	6 lbs	16"	\$70.99
20836	8 lbs	36"	\$102.99
21024	10 lbs	24"	\$106.99
21436	14 lbs	36"	\$143.99

WILTON BASH BALL PEIN HAMMER

Safety plate prevents head from dislodging, anti-vibe neck with tapered design eliminates vibration from striking, no-slip grip made from vulcanized rubber ensures a secure hold, patented unbreakable technology made from spring steel rods throughout allows hammer to take maximum abuse with minimal wear and tear.

PART	HEAD	HANDLE	PRICE
32414	24 oz	14"	\$38.99
33214	32 oz	14"	\$44.99
34014	40 oz	14"	\$50.99

WILTON BASH CROSS PEIN HAMMER

Safety plate prevents head from dislodging, anti-vibe neck with tapered design eliminates vibration from striking, no-slip grip made from vulcanized rubber ensures a secure hold, patented unbreakable technology made from spring steel rods throughout allows hammer to take maximum abuse with minimal wear and tear.

PART	HEAD	HANDLE	PRICE
30216	2 lb	16"	\$44.99
30316	3 lb	16"	\$54.99



JOBBOX ON-SITE STEEL CONSTRUCTION STORAGE CHEST

42" L x 23 3/8" H x 20" W. Superior strength to resist break-ins; bolt cutter free locking system; super-duty hinge resists forced entry; extra-strong bottom bolsters for heavy loads; rain drain system protects contents; grip rite channels resist damage

653990 - \$479.99

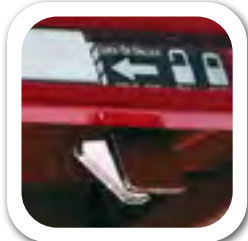
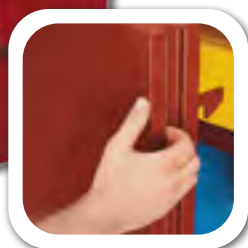

AMES TRUE TEMPER PICK MATTOCKS

36" fiberglass handle with guard, 5 lb; forged steel head for added strength; handle guard ensures that shaft is secured from coming loose.

1195100 - \$29.99



AMES TRUE TEMPER HERCULES HEAVY POST HOLE DIGGERS

Blade made from steel, handle made from white ash. 9-1/2" blade length, 6-1/2" blade width, 12 gauge blade thickness, 6-1/4" spread, 48" handle length.

1706100 - \$49.99



AMES TRUE TEMPER KODIAK WOOD SHOVEL

11-1/2" X 8-3/4" round point blade, 47" in white ash straight handle; extended blade socket for stronger connection between handle and blade.

1303900 Wood - \$29.99

1558300 Fiberglass - \$32.99



STERLING 9/16" ATLAS RIGGING LINE

9/16" arbor rigging line is made with a polyester sheath for great durability in all conditions. Its braided nylon core provides smooth handling and the ability to absorb dynamic forces. Works with a Port-a-Wrap, capstan winch or rigging blocks. The Atlas is spliceable or can be ordered with a sewn eye termination for knotless rigging.

LENGTH	DIAMETER	COLOR	STRENGTH	PART	PRICE
150'	9/16"	Blue	MBS 10,386 lbs	AT135060046	\$154.55
200'	9/16"	Blue	MBS 10,386 lbs	AT135060061	\$204.95
600'	9/16"	Blue	MBS 10,386 lbs	AT135060183	\$602.55
150'	9/16"	White	MBS 10,386 lbs	AT135000046	\$154.55
200'	9/16"	White	MBS 10,386 lbs	AT135000061	\$204.95
600'	9/16"	White	MBS 10,386 lbs	AT135000183	\$555.90
150'	9/16"	Yellow	MBS 10,386 lbs	AT135090046	\$154.55
200'	9/16"	Yellow	MBS 10,386 lbs	AT135090061	\$204.95
600'	9/16"	Yellow	MBS 10,386 lbs	AT135090183	\$602.55



STERLING SCION ARBOR CLIMBING LINE

The Scion's ability to absorb dynamic forces makes this rope ideal for DdRT, and SRS. The Scion is a double-braid featuring a burly polyester 24-strand sheath, yet engineered to have decreased elongation, soft handling and easy knotability. The durable sheath is designed to handle mechanical devices and run efficiently through hardware. The Scion can be hand spliced and is also available with sewn terminations.

LENGTH	DIAMETER	COLOR	STRENGTH	PART	PRICE
120'	11.5 mm	Blue	MBS 5,417 lbs	AC115060037SET	\$147.55
150'	11.5 mm	Blue	MBS 5,417 lbs	AC115060046SET	\$175.75
200'	11.5 mm	Blue	MBS 5,417 lbs	AC115060061SET	\$222.90
120'	11.5 mm	Orange	MBS 5,417 lbs	AC115070037SET	\$147.55
150'	11.5 mm	Orange	MBS 5,417 lbs	AC115190046SET	\$175.75
200'	11.5 mm	Orange	MBS 5,417 lbs	AC115070061SET	\$222.90
120'	11.5 mm	Green	MBS 5,417 lbs	AC115190037SET	\$147.55
150'	11.5 mm	Green	MBS 5,417 lbs	AC115070046SET	\$175.75
200'	11.5 mm	Green	MBS 5,417 lbs	AC115190061SET	\$222.90



STERLING 7/16" HTP STATIC

Maximum strength with low stretch. A multiuse rescue and rappel rope perfect for rope rescue, rope access and efficient ascending/descending. Low-stretch properties and high-moisture resistance allow the 7/16" to operate consistently in wet and dry conditions. Also available in our BiColor pattern, which provides an added safety measure for arbor climbing SRS systems.

LENGTH	DIAMETER	COLOR	STRENGTH	PART	PRICE
150'	11 mm	Black	MBS 6,856 lbs	P110040046	\$159.55
165'	11 mm	Black	MBS 6,856 lbs	P110040050	\$173.35
200'	11 mm	Black	MBS 6,856 lbs	P110040061	\$211.55
300'	11 mm	Black	MBS 6,856 lbs	P110040092	\$315.85
600'	11 mm	Black	MBS 6,856 lbs	P110040183	\$621.90
660'	11 mm	Black	MBS 6,856 lbs	P110040200	\$679.70



STERLING MARATHON LANYARD

A 10.7 mm non-adjustable dynamic rope cowtail for work positioning and back-up belay connection. Stitched-end terminations provide accurate lengths and eliminate bulky knots. Clear rubber shrink tube provides protection against abrasion. MBS 3,822 lbs.

SC106NYLY020 50 cm - \$20.05

SC106NYLY024 60 cm - \$20.50

SC106NYLY031 80 cm - \$21.45

SC106NYLY039 100 cm - \$21.85



STERLING RIT 9 MM PRUSIK

The 9 mm sewn cord products eliminate bulky knots, saves time in the field and maintain strength. The 9 mm cord is manufactured using Twaron, a heat and abrasion resistant material. These products are designed to work together as part of the arborist Tree Pulling Kit.

SC09APBLP016 16" - \$17.85

SC09AP2E028 28" - \$23.95

SC09AP2E032 32" - \$23.95

SC09AP2E036 36" - \$23.95



STERLING RIT 8 MM EYE TO EYE

Provides consistent friction in a wide variety of situations thanks to firmer/tight Twaron sheaths. The 8 mm version is made from RIT 500 cord which provides a firm feel and solid durability. ANSI compliant.

SC08AN2E028 28" - \$21.85

SC08AN2E032 32" - \$21.85

**ELVEX 91 SERIES PROCHAPS
CHAIN SAW LEG PROTECTION**

Chaps meet F-1897-2008 ASTM standard of leg protection for chain saw users, made from 1,000 denier and nylon materials, prolar protective padding, water resistant, front pocket with zipper, wrap-around calf protection style, and quick-connect leg buckles.

JE-9133 33" length - \$125.60

JE-9136 36" length - \$125.60

JE-9139 39" length - \$129.45

JE-9143 43" length - \$129.45



**PETZL SEQUOIA SRT
ARBORIST SEAT HARNESS**

Harness designed for ascents on single rope, extra-wide semi-rigid waist belt and leg loops give excellent support, attachment bridge is linked to (2) gated rings for length adjustment, facilitates carrying and organization of tools with multiple equipment loops and slot for attaching caritool tool holders.

C69BFA1 - \$444.95

C69BFA2 - \$444.95



**PETZL AVAO SIT FAST
ARBORIST SEAT HARNESS**

Harness designed for positioning and suspension, wide semi-rigid waist belt and leg loops give excellent support and allows for easy adjustment, facilitates carrying and organization of tools with multiple equipment loops and slot for attaching caritool tool holders.

C79AFA0 - \$299.95

C79AFA1 - \$299.95

C79AFA2 - \$299.95



SILKY ZUBAT 13" HAND SAW

Made from rubber and SK4 high carbon steel, 6.5 PPI teeth per inch, 13 in and 18.5 length, 1.4 mm blade thickness, 1.5 mm kerf, curved design allows for increased cutting speed with less effort required. Available in black and silver.

270-33 - \$101.95



SILKY TSURUGI HAND SAW

Made from rubber and SK4 high carbon steel, 6.8 PPI teeth per inch, 11.8 in and 19.5 in length, 1.8 mm blade thickness, 1.7 mm kerf, unique aluminum scabbard that can be attached to a belt or leg and has eight rollers protecting the entryway. Available in black and red.

450-30 - \$106.95



SILKY KATANA BOY FOLDING SAW

19-4/5 in blade length, 46-3/8 in overall length, 26 in folded length, 4 teeth per in, 2 lbs weight, black carrying case, security screw protects against accidental opening or closing of the blade, limited lifetime warranty against defects in material and workmanship.

403-50 - \$256.95



**SILKY HAYAUCHI
POLE SAW**

Made from rubber and SK4 high carbon steel, 5.5 PPI teeth per inch, 15.4 in, 20.7 ft, 8 ft lengths, 1.5 mm blade thickness, 2.3 mm kerf.

179-39 - \$412.99



ISC COMPACT RIGGING PULLEY

At approximately half the size of the standard small rigging pulley and weighing in at only 490 g (1 lb), offers a highly impressive strength to weight ratio with an 85 kN (19,000 lbf) MBS and a WLL of 17 kN (3,800 lbf). Fitted with a spring-lock closure mechanism. Working line (grey sheave): 13 mm (1/2") - 38 kN (8,500 lbf); topping strop (red sheave): 16 mm (5/8") - 74 kN (16,650 lbf).

RP048 - \$131.56



PETZL ZIGZAG TREE ROPE WRENCH ZK-2

Mechanical prusik allows the user to move around efficiently in a tree using classic prusik pulley system technique. The linked rings provide precision and fluidity when moving around. Pulley is mounted on sealed ball bearings to allow the slack to be taken up easily. Steel construction offers great durability.

D22A - \$279.95



KLEIN TOOLS TREE CLIMBERS GAFFS WITH PADS & STRAPS

15"-19" long, 8" x 8" cushioned, high-grade leather climber pads for maximum comfort. Neoprene-impregnated nylon climber straps for long-lasting life. Secure sleeve and leg iron connection. Steel split ring secures ankle strap in place and allows for quick replacement. 4-7/16" wide stirrup provides greater foot support.

52022 - \$321.99



ISC STRYDER FOOT ASCENDER

Provides smooth upward movement and positive engagement on the rope. Stainless steel coned cam-face allows positive engagement on the rope for a firm reliable grip, with minimal wear to the sheath. Foot-lever can be used to open / close the cam with the other foot. Foot-lever bar can be removed, allowing greater pivot range on cam. Fully adjustable on both the horizontal and vertical straps.

RP227 - \$70.00

SINGING TREE ROPE WRENCH

Made from aluminum. Used to create a 'bend' in the rope, above the climber's hitch. With the addition of a stiff tether, it created a contained double rope system on a single line of rope. This contained double rope system travels with the climber as they move around the tree, allowing a consistent level of friction on the hitch, which is impossible to achieve in double rope climbing.

RP280A1 + 8351ST2 - \$137.13



PETZL AIRLINE THROW-LINE

Combines flexibility for a precise throw and stiffness for avoiding knot formation as it comes out of the bag. Sheath-core bond maintains a round cross-section, ensuring good rope glide through the tree. Sheath is made of Dyneema for excellent abrasion resistance. Lightweight and yellow for excellent visibility.

R02Y060 - \$39.95

R02Y300 - \$179.95



PETZL JET THROW-BAG

Throw bag has rugged, two-layer construction for longevity. Streamlined shape facilitates passage through tree branches. Secondary connection point for quick attachment of the rope. Yellow for excellent visibility.

S02Y-250 - \$21.95



30" ARMOR PRUS 8 MM EYE AND EYE

Best suited to 11 mm and 11.7 mm climbing lines. Blended Technora cover to prevent melting and glazing, over a core of lightweight Spectra 900. Very low stretch. Technora is rated to 234°C higher than standard polyester.

3411304 - \$25.00

STANLEY

STANLEY 17 OZ CLASSIC VACUUM FOOD JAR

Vacuum insulation keeps food and drinks hot or cold for 12 hours 17 oz / 502 mL; 18/8 stainless steel won't rust, naturally BPA free; insulated lid doubles as 12 oz / 354 mL cup; leak proof and fully packable.

10-00131-019 - \$28.99



STANLEY ADVENTURE COOLER PLUS VACUUM BOTTLE COMBO

Perfect lunch solution for work or recreation, cooler: 7 qt / 6.6 L, leak resistant gasket, locks in cold for up to 27 hours, foamed lid and body, 3x the foam of typical cooler, keeps cold 38% longer, sturdy latches and hinges for added durability, keeps lunch fresh, vacuum bottle: 25 oz / 750 mL, vacuum insulation keeps drinks hot or cold 15 hours, 18/8 stainless steel won't rust; naturally BPA-free, insulated lid doubles as cup, leak proof and fully packable.

10-01688-001 - \$64.99

10-01622-001 Cooler only - \$39.99



STANLEY 16 OZ ONE HAND VACUUM MUG

Vacuum insulated body - thermal lid keep drinks hot 6 hours, cold 24 hours; 6 oz / 473 mL, 18/8 stainless steel won't rust, naturally BPA free, push button lid lets you open, drink, close with one hand; leak proof and fully packable, dishwasher safe lid disassembles for deep cleaning.

10-01394-007 Green - \$24.99

10-01394-008 Navy - \$24.99

10-01394-059 Red - \$24.99



STANLEY 25 OZ CLASSIC VACUUM BOTTLE

Vacuum insulation keeps drinks hot or cold for 15 hours, 25 oz / 750 mL, 18/8 stainless steel won't rust, naturally BPA free, insulated lid doubles as 8 oz / 236 mL cup, leak proof and fully packable.

10-01612-002 - \$29.99



STANLEY 1.4 QT CLASSIC VACUUM BOTTLE

The Classic 1.4 qt is the same size as the iconic 1.1 qt thermos but holds an extra cup, vacuum insulation keeps drinks hot 24 hours or cold 32 hours, 1.4 qt / 1.3 L, 18/8 stainless steel won't rust, naturally BPA free, locking handle, insulated lid doubles as 8 oz / 236 mL cup, leak proof and fully packable.

10-01032-025 - \$44.99



SQWINCHER QWIK STIKS ZERO 50 PACK

(50) sticks of your favorite flavors in a case, replace electrolytes and stay hydrated, sugar free, calorie free, no mixing or stirring needed, fast on-the-go hydration. Available in fruit punch, orange, mixed berry, lemonade, lemon lime, and grape.

690-06010 50 sticks - \$21.99



SQWINCHER QWIK STIKS ZERO

(10) sticks of your favorite Stiks in a carrying tube, add one pack to a 20 oz bottle of water and enjoy, perfect way to replace electrolytes and stay hydrated anywhere you are, sugar free – calorie free to support a healthy lifestyle, no mixing or stirring needed, fast on-the-go hydration. Available in fruit punch, orange, mixed berry, and strawberry lemonade.

060119SQ 20 tubes (10 sticks/tube) - \$109.99



SQWINCHER SQUEEZE POPS PACK

Reduce core body temperature with Squincer's scientifically developed formulation that is absorbed into the body at a significantly faster rate than water, allowing the body to replenish the electrolytes and minerals needed for proper rehydration. Great for sporting and industrial use. Available in lemon lime, cherry, grape, mixed berry, and orange. (10 pops per pack)

159200201 1 Pack - \$3.99

159200201 15 Packs - \$48.99



KENWOOD PROTALK 2 WATT 4 CHANNEL RADIO

Ergonomically contoured and engineered for superb ease of use and audio clarity, even in noisy environments, ProTalk boasts rugged reliability for dependable communications in all weather conditions. Specially designed "Stubby" antenna reduces overall radio size without loss of signal or reception.

TK-3400U4PS - \$219.00

ASK ABOUT KENWOOD REBATES



KENWOOD NYLON CARRYING CASE

Black nylon case that allows access to the radio's controls in the case, allowing use of the radio without taking the case off; compatible with Kenwood TK-2400, 3400, 2402 and 3402 radio series; protects radio, snapping belt loop, superior quality, 1-year warranty.

KLH-187 - \$15.00



KENWOOD RAPID CHARGER

Kenwood's KSC-35SK rapid-rate desktop charger replenishes the charge on a single Kenwood KNB-45L 2000 mAh Li-Ion battery for TK Series two-way radios, 1-year warranty.

KSC-35SK - \$31.49



KENWOOD SIX UNIT CHARGING RACK

Provides power to (6) KSC-35K chargers, allowing you to charge up to (6) radios simultaneously, compatible with Kenwood TK-2400, 3400, 2402 and 3402 radio series, charging cups included with radios, 1-year warranty.

KMB-28 - \$199.99

KENWOOD

BEST IN CLASS TWO-WAY RADIOS

TK-3400U4P SPECIFICATIONS

4 Channel UHF 2 Watt
Wireless Cloning
90 UHF Programmed Banked Frequencies
39 QT / 168 DQT Privacy Codes
Diecast Chassis
Weather Sealed Construction
1 Watt Audio Output
Removable Antenna
2,000 mAh Li-Ion Battery with up to 22 Hours of Talk Time
Advanced Ergonomic Controls
Fast 2.5-3 Hour Charge Time
Weights Only 9.9 oz with Battery
Meets Military Spec 810 Standards
Compatible with Other Business Radios Operating on the Same Frequency & Code
Up to 6 Mile Range in Opens Areas
Includes Radio, Antenna, Battery, Fast Charger, Belt Clip, & Owner's Manual



KENWOOD COMPACT SPEAKER MIC

Plugs directly into a ProTalk or FreeTalk radio and offers an incorporated push-to-talk button. This speaker microphone features a compact, low-profile design, and is compatible with all TK model radios.

KMC-21 - \$50.00



KENWOOD 1.5 WATT PROTALK LT POCKET-SIZED RADIO

Weighing just 3.9 oz, this small but powerful two-way radio provides 1.5 watts transmit power, (4) channels, enhanced Kenwood audio, 3.5 mm audio jack for hands free operation, LED battery status indicator, battery saver, time out function, wireless clone, 2-year warranty. Connect to a standard micro USB port to charge or use included charging cup, meets 8 Mil-Spec standards. Includes 1,430 mAh Li-Ion battery, 3-hour fast charger, and belt clip.

PKT-23 - \$144.00

KHS-33 Earbud headset - \$28.00

KHS-34 C-Ring headset - \$35.00

KMB-44 6 Unit charging rack - \$167.00



KENWOOD PROTALK UHF PORTABLE RADIO

UHF 16 Channels, 5 Watt; 39 QT / 168 DQT privacy codes, super lock, VOX ready, privacy talk scrambler, 10-call alert tone wireless cloning, channel scan, removable antenna, diecast chassis, weather-sealed construction, meets 11 Mil-Spec standards, Li-Ion rechargeable battery, spring action belt clip, fast charging cup, removable antenna, 2-year radio warranty.

TK-3402U16P - \$289.00

TK-3230K SPECIFICATIONS

6 Channel UHF 1.5 Watt
Wireless Cloning
64 Pre-Set Frequencies
39 QT / 168 DQT Privacy Codes
Enhanced Kenwood Audio
10 Call Alert Tones
Wireless Cloning
4-Digit 7-Segment LCD with Backlight
2,000 mAh Li-Ion Battery Offering up to 18 Hours of Operation
VOX Ready
Fast 2.5 Hour Charge Time
Weighs Only 5.5 oz with Battery
Meets Military Spec 810 Standards
Compatible with Other Business Radios Operating on the Same Frequency & Code
Up to 5 Mile Range in Opens Areas
Includes Radio, Battery, Fast Charger, Belt Clip, & Owner's Manual
2 Year Warranty

DEMO UNITS AVAILABLE
CALL FOR DETAILS

KENWOOD LI-ION REPLACEMENT BATTERY

High quality lithium ion DC 3.7 V, 2000 mAh cell that is designed to work with the Kenwood TK-3230 series radios, 1-year warranty.

KNB-46L - \$48.99
KNB-45L For TK-3400U4P - \$62.99



KENWOOD RAPID CHARGER

Rapid rate desktop charger that is designed to work with the Kenwood TK-3230 series radios, compatible with KNB-46L Lithium Ion Battery Pack, great as a replacement or spare, 1-year warranty.

KSC-37 - \$31.49



KENWOOD SIX UNIT CHARGING RACK

Provides power to (6) KSC-28 or KSC-37 chargers, allowing you to charge up to (6) radios simultaneously, compatible with Kenwood TK-3230 radio series, charging cups included with radios, 1-year warranty.

KMB-27 - \$199.99



KENWOOD 1.5 WATT PROTALK UHF BUSINESS RADIO

Two-way radio specially designed for demanding use with clear communications in a small compact size (5.5 oz with battery). You can't beat this combination of power, size, and battery life!

TK-3230DX - \$164.00



KENWOOD BEHIND-THE-HEAD HEADSET

Omni-directional microphone with foam wind screen, sliding clothing clip, adjustable boom mic for ease of use, in-line push-to-talk (PTT) with hands-free VOX, single ear receiver, combines functionality and style, designed for all-day use, compatible with TK-3400 and 3230, 1-year warranty.

KHS-22 - \$40.00



KENWOOD D-RING HEADSET

Soft rubber D-ring ear loop hanger with speaker, ear loop can be worn on either ear, lightweight and balanced to provide all day comfort, in-line PTT with clothing clip, compatible with TK-3400 and 3230, 1-year warranty.

KHS-27 - \$25.00

T-REIGN PROHOLSTER POUCH

Open-top protective case with a retractable tether, designed for two-way radios or any other small device, rugged 36" Kevlar tether is strong and durable, prevents drops and loss of gear; patent-pending hook and latch closure system, one-handed access to gear; constructed with rugged 600 denier nylon, tether cord can stretch to accommodate up to a 6" tall device, 2" wide x 1.1" deep.

908471 - \$29.99



ProTalk®

THE RIGHT TOOL THE RIGHT CHOICE

Compact, durable business two-way radios from Kenwood



KENWOOD
BEST IN CLASS TWO-WAY RADIOS



**ONE WEEK
NO RISK
FREE TRIAL**



MOTOROLA DIGITAL ON-SITE TWO-WAY RADIO

1 W Digital 900 MHz ISM band, 6 channel radio; with DLR digital technology, voice communications are louder and clearer across an extended range without static, ensuring that your voice is crisp and clear even at the outside edge of coverage; DLR series is license free, eliminating the need for regulatory paperwork and licensing applications and fees; Private Reply feature allows users to instantly communicate one to one privately after a group transmission is over; Call All Available or Page All Available features are flexible group communications that can reach all users available; Home Channel designates a specific channel as "home" so the radio automatically reverts back if the user was speaking on a different channel; Communicate across an extended range of 300,000 sq ft and up to 20 floors; Unique group privacy allows a radio fleet to be set up with a unique 4-digit radio profile ID so you're assured private communication without interference; Long battery life provides up to 14 hours of operation; DLR radios meet test methods for military standards 810 C, D, E, F, and G.

DLR1060 - \$259.00

DLR1020 2 Channel Radio - \$239.00

MOTOROLA ON-SITE TWO-WAY BUSINESS RADIO

2 Watt, up to 15 hours battery life, Lithium Ion, up to 20 floors or 250,000 sq ft coverage area, 450-470 MHz frequency range, (99) UHF frequencies make signals extra-secure and exceptionally clear, (219) codes; powerful speaker delivers premium-quality audio for clear communications in noisy conditions; comfortable to wear all day, with easy-to-use interface that requires little or no training; takes on tough conditions with a durable metal diecast chassis that meets Military Standards and IP54/55 specs; antimicrobial protection helps prevent the growth of mold and germs on the surface of the radio; tri-color LED easily identifies different radio features and radio status; Advanced Voice Activation (VOX) adds convenience of hands-free operation with optional accessories; drop in charger keeps radios charged, ready and centrally located; LED lights on multi-unit charger provides a charge status to give you confidence that your radio is charged and ready; Easy to program with any computer web browser; seamless transition from previous RDX series of two-way business radios.

RMU2040 - \$245.00

PMLN6384 6-unit charging rack - \$275.00

MOTOROLA DURABLE REMOTE SPEAKER MICROPHONE

Conveniently clips to your front lapel or pocket allowing you to talk and listen without removing your radio from the belt or case, built and rigorously tested to the same quality standards as Motorola radios, includes speaker, microphone, and push-to-talk button; compatible with CLS1410 and RDU2020.

HKLN4606 - \$63.00



MOTOROLA TWO-WAY RADIO HOLSTER

Heavy-duty, two-way radio holster designed to protect all professional walkie-talkie Motorola XU/XV/RD series, black leather, swivel design makes kneeling/bending more comfortable, quick release quickly disconnects from the stainless steel belt clip.

MR8461-2AP - \$35.00



MOTOROLA ON-SITE TWO-WAY BUSINESS RADIO

1 Watt, up to 12 hours battery life, Lithium Ion, up to 200,000 sq ft. (15 Floors) coverage area, 461-470 MHz frequency range, VibraCall alert lets users discreetly receive transmissions, flexible choice of frequency and channels, uses (4) channels and operates on (56) business-exclusive frequencies, private line codes (PLCs), (121) interference eliminator codes maximize choices through (83) digital and (38) analog private lines, voice-operated transmit enables hands-free operation, simplified cloning quickly copies settings from radio to radio, choice of rechargeable lithium ion or backup AAA, 1-year standard warranty.

CLS1410 - \$209.00





MultiWave Sensors

ASK ABOUT
FINANCING
OPTIONS

**MULTIWAVE SMARTALIGN
SMART ALIGNER SYSTEM**

The Multiwave Smart Aligner System is a GPS-based compass designed to effectively and efficiently align your antennas in real time. The Smart Aligner solution is designed for ease of use and unparalleled accuracy that provides a True North or Grid North azimuth measurement, Tilt, Roll and Position. Once the system is mounted to the antenna, it is simply turned on. From there the user interface is the full feature app on any iOS and Android smart device. Reporting is as simple as a few clicks with the report being able to be e-mailed directly from the app. The system has been tested in the harshest RF live antenna environment while still maintaining it's accuracy. The Smart Aligner solution is accurate, fast and scalable creating an effective solution for all your alignment needs. First foldable GPS antenna alignment tool; universal mounting bracket; multiple antenna mounting configurations for the most demanding spatial and RF conditions; tool and bracket fit into ruggedized case; carry on baggage acceptable size; includes backpack to carry the tool and bracket; weighs only 10 lbs; free smartphone app.

SMARTALIGN - \$4,995.00

**MULTIWAVE 2-YEAR
EXTENDED WARRANTY**

Period: 24 months from time of shipment to end customer. Warranty Coverage: parts and labour for manufacturer defects. Accidental Damage: parts and labour repair of all parts. Replacement of all parts if beyond repair (complete Tool replacement requires deductible). Not Covered: Loss, theft, fire, neglect.

WARRANTY - \$1,500.00



**MULTIWAVE
EXTRA TALL TCPD POUCH**

16" height, 9" length, 5" width, 3 exterior D-ring connection points, extra tough Cordura closing top with drawstring, bull-pin loop on each side, inside pocket, tunnel loop belt connection, up to 3" wide belt capacity.

5516MW - \$39.99



MULTIWAVE BACKPACK

The Multiwave Backpack makes transporting the Smart Aligner up the tower easy, protects device while climber ascends to platform to work, extra pockets allow separate storage of logs, extra tools, laser rangefinder, or smartphone.

BACKPACK - \$75.00



**MULTIWAVE SMART ALIGNER RUGGEDIZED
CARRYING CASE**

Has enough room and compartments to hold the Smart Aligner, bracket, and all the components. Use this rugged carrying case for shipping or transporting the Multiwave Smart Aligner. The Smart Aligner Carrying case is even an approved size to be used as carry on baggage while flying. Weighs 12 lbs, 21" x 16" x 8.5".

SMARTCASE - \$500.00

MultiWave Sensors

MULTIWAVE SMART ALIGNER DISH BRACKET MOUNT

Attaches to dish bracket horizontal bar. Provides mounting base for tool. Tether included. Hex key included for assembly with directions. Horizontal bar comes in 4 sizes for different dish diameters: 2' bar for 1.5'- 2' diameter dishes, 3' bar for 1.5'- 4' diameter dishes, 4' bar for 1.5'- 8' diameter dishes, 6' bar for 1.5'- 16' diameter dishes.

- DISHBRACKETMOUNT - \$200.00**
- DISHBRACKETHB2 2' bar - \$85.00**
- DISHBRACKETHB3 3' bar - \$110.00**
- DISHBRACKETHB4 4' bar - \$135.00**
- DISHBRACKETHB6 6' bar - \$175.00**



MULTIWAVE DISH ADAPTER

Microwave dishes come in a variety of shapes and sizes. The Multiwave Dish Adapter enables the user to attach the Smart Aligner to their own custom bracket they have fabricated.

DISHADAPTER - \$50.00

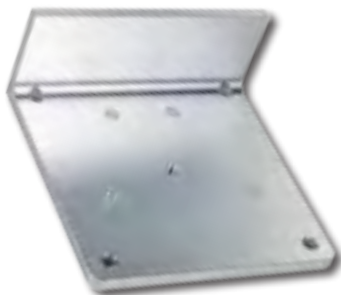

MULTIWAVE SMART ALIGNER INSERT

Install the Insert into Multiwave's Universal Bracket to ensure greater accuracy when working with AIR antennas.

- AIR21INSERT - \$175.00**
- AIR32INSERT - \$150.00**

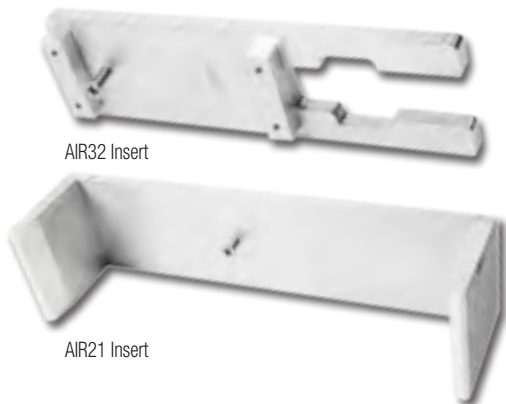

MULTIWAVE UNIVERSAL BRACKET

The Multiwave Smart Aligner Universal Bracket attaches directly to the left or right side of the antenna to be aligned. The Smart Aligner tool can then be attached to the universal bracket in three different positions. Comes included with the purchase of the Smart Aligner Antenna Alignment System. Purchase an extra Universal Bracket as a replacement or spare. The Universal Bracket fits into the Multiwave carrying case (sold separately) for easy transportation. Tether line to prevent drops. Durable ratchet to ensure secure connection.

UNIVERSALBRACKET - \$600.00



MULTIWAVE GOGO BRACKET

The Gogo Bracket is used in place of the standard Smart Aligner bracket for Gogo antennas. Attaches to the Smart Aligner at the top of the Gogo antenna and fastens to the vertical plate. Comes complete with a tether line and clip. No extra tools required for attaching to the Smart Aligner. Fits inside the accessory bay of the carrying case.

GOGOBRACKET - \$280.00



MULTIWAVE LASER AGL CABLE

The Multiwave Laser AGL Cable connects the Smart Aligner to TruPulse laser rangefinders, allows vertical range distance to be imported to Smart Aligner, sends information to smart phone app.

LASERAGLCABLE - \$100.00



TRUPULSE 200 LASER RANGEFINDER

Measures slope distance, inclination, and calculates horizontal and vertical distance with the push of a button; use in place of a tape drop to perform an AGL measurement; in-scope data display with 7x power optics and a serial port; attaches to Multiwave Smart Aligner via Laser AGL Cable.

7005026 - \$799.99

7005031 With Bluetooth - \$899.99



ANTENNA ALIGNMENT FROM

\$4,995

MORE ACCURACY, FASTER RESULTS, ~~OR~~ AND LOWER COST.

They say you can only pick two of the three. Not with the SmartAligner. Whether you're upgrading your network, managing a deployment project, or aligning antennas on the tower, the SmartAligner checks every box. It's dead-on accurate. It provides readings with lightning speed. And it's now more affordable than ever. It really is like no other antenna alignment tool.

SmartAligner
LIKE NO OTHER ANTENNA ALIGNMENT TOOL

CARRIERS

Accuracy
RF environment
Future proof

TURF

Improved reporting
Decreased user error
Lower site revisits

CONTRACTORS

Speed
Cost savings
Flexibility



CALL GME SUPPLY
(800) 940-6762



SUNSIGHT ANTENNALIGN ALIGNMENT TOOL

Used during equipment installation or antenna position audits. Quick capture feature for on-site captures; Durable, weatherproof and rugged for tough conditions. Readings can be taken in seconds via any W-Fi device, instantly creating a permanent record of an antenna alignment. Desired equipment position can be input prior to climb or entered into the tool on-site. Report records the final alignment specification, including latitude/longitude, azimuth, tilt, height, and current date/time, and also indicates its height above ground level.

AAT-30 - \$6,999.00



SUNSIGHT MICROWAVE PATH ALIGNMENT

This new system can be used to quickly, simply and accurately to align point-to-point, short-haul and long-haul links. The system automatically calculates exact alignment requirements in real-time and provides the user simple targets for pathing the link. No additional software, post processing, or cables are required.

1008 - \$19,999.00

1015 - \$18,999.00



SUNSIGHT LASER RANGEFINDER

Capture the above ground level (AGL) height within 1 foot (0.3 meters). This Rangefinder is used in place of a traditional tape drop and can be used with the Sunsight AntennAlign Alignment Tool. Includes cable cord.

3301 - \$1,100.00

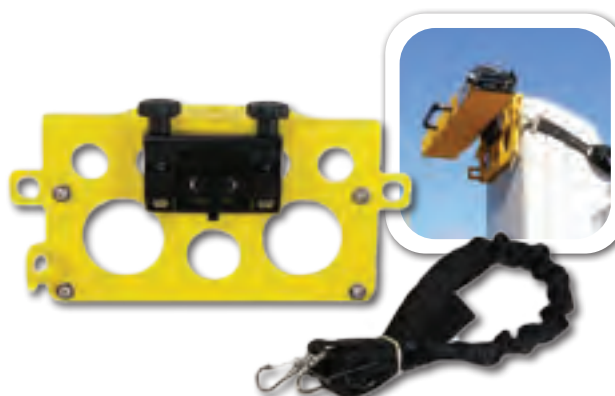

SUNSIGHT AIR ANTENNA MOUNT

10 lbs, 1.7" height, 3.8" width, 20" length. For use in conjunction with the AAT-30 or AAT-15 to Align Ericsson Air Antenna models, the Air11, Air21, or Air32. Required by Ericsson mandate for alignment of Air21 or 32 antennas when using Sunsight Alignment Tool.

2100 - \$349.00

3 STEP EQUIPMENT FINANCING

1

PAY ADVANCE FINANCE PAYMENT

Pay 20% of the equipment cost as a down-payment. This is the first month's finance payment.
Example: \$5,000 equipment cost = \$1,000 (down-payment).

2

CALCULATE THE MONTHLY PAYMENT

Subtract the down-payment from the equipment cost. Then divide this by the 11 remaining months.
Example: \$5,000 equipment cost = \$1,000 (down-payment) = \$4,000/11 = \$363.64/month for 11 months.

3

BUY OUT FOR \$1.00

You will own the equipment at the end of the finance term for \$1.

Call or visit gmesupply.com for more info. \$75 application processing fee may apply. Financing only available for antenna aligners.



3Z ANTENNA WASP SENSOR

The WASP is a Wireless Antenna Sensor Pod that when attached to an antenna, hourly monitors its alignment in 3 dimensions: azimuth, down-tilt, and roll. The Antenna WASP will detect and report any undesired changes to all antennas being monitored (up to 18 antennas per site). The WASP allows network operators the ability to login to a specific communication facility and view the history of all changes. Features: high reliability, 10 + year battery life, ultra-low power consumption, +/- 0.5 tilt accuracy, weather proof packaging IP 67, no maintenance, and on site and remote antenna monitoring.

3ZAW-1000A - \$99.95



3Z TORQUE WRENCH

The ideal tool for sealing the 3Z Antenna WASP and preventing damage to the unit. This torque wrench helps to ensure that the technician properly seals the WASP with out under or over torquing the screws.

3ZAW-TW20 - \$99.95



3Z DATA COLLECTOR

The Data Collector forwards information that has been collected by the 3Z Antenna WASP. The information can be forwarded to wireless carriers, NOCC, operations staff, and RF engineers. The data collector is placed at the base of the tower or nearby communication facility in order to work in conjunction with the WASP.

3ZAW-1000D - \$499.95



3Z STRAP CLAMP

Designed to quickly mount the 3Z RF Aligner to a wide variety of antenna types. The double strap ratcheting system allows for secure fastening to panel antennas and drum antennas that range from 1' to 10'. The Strap Clamp has 360° mounting capabilities as well. Two standard 8' Polyester webbing straps come included with the Strap Clamp. Weighs 2 lbs 12 oz, 4.98" H x 5.13" W x 13.5" L.

3ZRFA-SC1 - \$499.95



3Z VISION ANTENNA ALIGNMENT TOOL

This device replaces a compass, GPS, and range finder. Comes with a rugged designed hard-case, universal strap clamp, soft-case bag, rubber bumpers, AC/DC power charger with 3 Year Manufacturer Warranty. Only tool with 5" touch screen LED display; impact resistant display; weather resistant; maximizes voice quality and data traffic; improves data user throughput and KPI's; reduces churn; mechanically aligned with HD camera; connects to multiple constellations; multiple frequency technology.

3ZRFVISION - \$6,995.00



3Z RF AIR32 ANTENNA BRACKET

1 lb 11 oz, 8.75" height, 5.7" width, 4.1" length. 360 degrees mounting capabilities. The AIR Mount was designed to be a light weight, precise and easy to use mounting solution for the AIR32 antenna. Allows for quick installation by utilizing ball bearings to spin mounting posts onto existing AIR bracket hardware.

3ZRFA-A32 - \$299.99



3Z REPLACEMENT ALUMINUM STANDARD SIZE ANTENNA BRACKET

The Standard Size Bracket works with the 3Z RF Aligner to properly mount the device. Purchase this bracket as a spare or replacement. 3Z's RF Aligner was designed by RF engineers in order to eliminate the need to carry a compass, GPS, and range finder to site inspections.

3ZRFA-SAB - \$395.95

**NEW FEATURE
SPOTLIGHT**

Shaped response

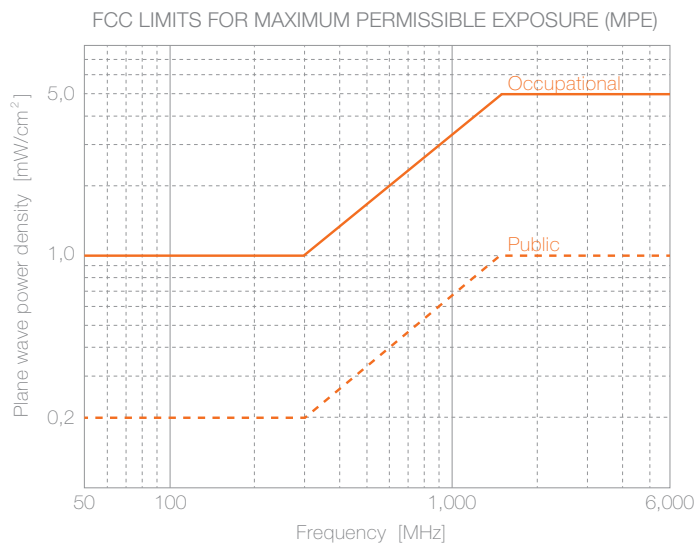

With the upgraded FieldSENSE 2.0, you're covered, even if you're working around multiple types of RF.

The FieldSENSE 2.0 is one of the only RF Monitors available with shaped response. It takes all exposures present on the site and combines them to give an overall exposure reading in terms of the FCC MPE. Without this reading, you may be unknowingly working in more RF than is being reported.





SUUNTO AZIMUTH COMPASS

Fast, accurate compass provides built-in precision and error-free operation; estimations can be made to 1/4°, housing is made of machined lightweight alloy; declination range is ±26° E / W (13° each way), accuracy ±0.5, optically magnified graduated scale, liquid-filled needle chamber, cotangent table, conversion table has cotangent 1°–45°, intervals of 1°; graduated 0°–360° in 1° increments, includes neck cord and case, measures 2"W x 3"L x 5/8"D.
KB-14/360RD - \$169.99



SUUNTO VISTA COMPASS

Features black azimuth scale division, reverse scale for taking cross bearings, optically magnified graduated scale and an index line, graduated 0–360° at 1° intervals, compass readings to 1/2° accuracy, housed in a lightweight, weatherproof ABS plastic that floats; includes lanyard, measures 2"W x 3"L x 5/8"D.
KB-20 - \$83.99



VIDEO

LEICA DISTO GEOSYSTEMS LASER DISTANCE METER

660' Range, easy and effortless outdoor distance measurement, unique combination of digital pointfinder and 360° tilt sensor allows measurements which are not possible with conventional distance meters, Bluetooth® Smart and attractive free app allow distances to instantly be transferred to iPhone or iPad for easy sketching, pointfinder with 4x zoom, IP65 water jet protection and dust tight, Smart Horizontal Mode™, height tracking, area/volume measurement, painter function, triangle/room angle, inclination tracking, Pythagoras functions, sloped object measurement, stake-out function, full functioning calculator, tripod thread for stable mounting, uses 2 AA 1.5 V batteries, 5.6" x 2.3" x 1.1".
E75001 - \$598.99



NARDALERT S3 MONITOR WITH DATA LOG CODE

Features field replaceable sensor modules, color LCD display, multi-color alarm LED's, USB interface for data and charging, interchangeable lanyard or belt clips, comprehensive software included, fiber optic port for remote monitoring, fail-safe design.
368375LOG - \$2,049.99



NEW CUSTOMER CHOICE VIDEO

FIELDSENSE 2.0 PERSONAL RF SAFETY MONITOR

With this device, you're covered. The FieldSENSE 2.0 is the next generation in Personal RF Monitors. Specifically designed to protect personnel working near broadcast and telecommunications transmitting antennas from EMF/RF overexposure. The FieldSENSE 2.0 measures both E & H fields spanning from 50 MHz to 6 GHz. It covers all typical television and FM broadcast services and all mobile telecom services; shaped response, to more accurately measure exposure; isotropic design ensures the combination of all sources of radiation from all angles are correctly measured and assessed; data logging records all your measurements, and can be accessed via USB for evaluation after work is completed; fall-detect function will sound an alarm if a fall is detected to attract attention of other climbers; unique harness fastening system keeps device secure on the climber; IP64 enclosure uses the same polycarbonate used in riot shields, and rugged elastomer outer is made for tough environments; voice notes can be taken and listened to after work is completed; uses standard AAA batteries; water resistant; bright LEDs, visible in sunlight; single button operation; includes zipper case with molded foam insert.
FS2.0 - \$599.99

fieldSENSE
 Personal RF Monitor



S  **FETY** **LMS**

THE TOWER INDUSTRY'S #1 SOURCE FOR TRAINING

**TRADE IN YOUR OLD NON-COMPLIANT
CARD FOR A DISCOUNT**

safetylms.com | (512) 710-5000



COMPETENT CLIMBER / RESCUER

Duration: One full day of classroom instruction and two full days of on-site instruction teaching basic and advanced tower rescue and climbing procedures.
Course description: This course is designed for climbers with 90+ days of tower experience. Throughout the 3 days of class, students will learn and demonstrate the skills needed to safely perform day to day tower work, while also having the necessary skills to perform multiple types of rescues in an emergency. The class can be fully customized to suit a company's needs, classes can be ran at one of the Safety LMS facilities across the US or at the companies private headquarters.

10001 - \$1,495.00



COMPETENT RIGGING PER ANSI 10.48 STANDARD

Duration: One full day classroom course.
Course description: This course details all aspects for the ASSE/ANSI 10.48-2016 Standard and is designed with specific emphasis on load calculations and rigging plans for antenna and line and structural modifications crews using a capstan hoist as the primary means of lifting loads with a line pull not exceeding 1,000 lbs. This course is intended for individuals who are experienced riggers, qualified persons or qualified engineers.

10002 - \$795.00



COMPETENT CLIMBER / RESCUER TRAIN THE TRAINER

Duration: One full day classroom course and two full days on-site practical instruction.
Course description: This course will allow qualified individuals to become certified to teach both Authorized Climber / Rescuer and Competent Climber / Rescuer in-house. A qualified individual has 5+ years of practical climbing experience and holds a current Competent Climber/Rescuer card. The company must also meet a set of basic requirements. Upon completion, trainers will be provided with a packet of course material and all of the tools to train their entire team up to a Competent Climber / Rescuer level.

10005 - \$3,695.00



COMPETENT RIGGING TRAIN THE TRAINER

Duration: One full day classroom course.
Course description: This course will allow qualified individuals to become certified to teach the Competent Rigging curriculum in-house to their companies employees. A qualified individual has 5+ years or climbing and/or rigging experience and holds a current Climber / Rescuer Certification. The company must also meet set of basic requirements. Upon completion, trainers will be provided with a packet of course material and all of the tools to train their entire team up to a Competent Rigging level.

10007 - \$2,895.00



CAPSTAN HOIST OPERATIONS

Duration: Half-day classroom course. Optional practical instruction available with additional cost.
Course description: This course covers the use of Capstan hoists on communications sites. There are several types and designs of Capstan hoists that will be covered in this class, along with their use and hazards associated with operating the various units. The intent of this course is to give each student the basic understanding to make good decisions while operating. This course combined with practical experience will help prevent accidents and create better operators. A certificate of completion will be issued upon successful completion of the written exam.

10003 - \$495.00



GIN POLE THEORY & APPLICATION

Duration: Half-day classroom course. Optional practical instruction available with additional cost.
Course description: This course was designed to exceed the TIA-PN-4860 Gin Pole standard for "Design and Use" and as referenced by the OSHA Directive CPL-1.36. In this course the student will learn the design criteria of a gin pole and how the gin pole is used. Some topics covered in the course include Unique Loading conditions, Types of Tagging and their Loads and Repairs and Modifications.

10006 - \$795.00

INSPECTION LOG

FREE
DOWNLOAD

TRUCK NUMBER: _____
DESCRIPTION: _____
PURCHASE DATE: _____
SERVICE DATE: _____

NAME / DEPT: _____
DIVISION: _____
UNIT: _____

PASSES INSPECTION Y/N
HARDWARE Y/N
PROPER ANCHORAGE Y/N
PICKOFF SYSTEM Y/N
DESCENT DEVICE Y/N
UNIFORM DIAMETER Y/N
SHEATH GLAZING Y/N
ABRASION/FRAYING Y/N

RETURN TO
SERVICE
Y/N/DATE
INSPECTED
BY

DATE	LOCATION	CONDITIONS																	

COMMENTS

NOTES

GEAR CHECKLIST

Make ordering easy with these convenient checklists. Use them as a guide to make sure you have everything you need or give them to each person on your crew. To make things even easier, we can turn your list into a custom kit with a part number unique to your company. Call our Gear Experts® at (800) 940-6762 for more info.



TOWER CLIMBING

QTY	ITEM	PAGE(S)	PART NUMBER
	Climbing Helmet	120-123	
	Harness	8-11	
	Twin Leg Lanyard	33-37	
	Cable Safety Sleeve	86	
	Rope Grab with 3' Lanyard	69-70	
	Snaphook Spreader Bar	59	
	Positioning Device	40-42	
	Anchor Slings	53-54	
	Bolt Bags	114-116	
	Carabiners	58-59	
	Tool Lanyards	179-181	
	Gear Bag	117-119	

Equipment for: _____

Need by date: _____

GENERAL PPE & SAFETY

QTY	ITEM	PAGE(S)	PART NUMBER
	Hard Hat	120-123	
	Safety Glasses	124-126	
	Gloves	130-135	
	Hearing Protection	128-129	
	Work Boots	154	
	First Aid Kit	138-140	
	Hi-Viz Apparel	149-151	
	Job Site Banner	160	

LIFTING & RIGGING

QTY	ITEM	PAGE(S)	PART NUMBER
	Capstan Hoist	90-91	
	Mount	90-91	
	Generator	167	
	Handline Block / Snatch Block	95	
	Slings	100-101	
	Shackles	98	
	Load Rated Carabiners	99	
	Canvas Buckets	110-113	

RESCUE

QTY	ITEM	PAGE(S)	PART NUMBER
	Rope	63-65	
	Descent Device	71	
	Pick-Off System	82-85	
	Small Carabiners	58-59	
	Anchor Strap	53-54 100-101	
	Gear Bag	117-119	

ROPE

QTY	ITEM	PAGE(S)	PART NUMBER
	Safety Line	63-65	
	Load Line	93	
	Tag Line	63-65	
	Pulleys	74-75	
	Rope Bag	66	

TOWER TOOLS

QTY	ITEM	PAGE(S)	PART NUMBER
	RF Monitor	202	
	Two Way Radios & Accessories	192-195	
	Power Tools	172-175	
	Grounding Molds	161-162	
	Antenna Alignment Tool	196-200	

STANDARDS INDEX

Nearly every piece of safety equipment is regulated, as are the safety practices on the job. The information below is simply a guide for what is referenced in each standard and chapter. The full standard provides very specific detail for all aspects of the standard. For more information, give our Gear Experts® a call!

ANSI 10.48 STANDARD (BEST PRACTICES AND USE)

The Criteria for Safety Practices for the Construction, Demolition, Modification and Maintenance of Communications structures in the USA.

- General considerations
- References
- Definitions
- Pre-job planning
- Job site conditions
- Fall protection
- Radio frequency/electromagnetic energy
- Base mounted hoist used for material lifting and personnel lifting
- Personnel lifting accessories and processes
- Rigging
- Gin poles and other lifting devices
- Climbing facilities and access
- Structural construction loading considerations
- Training program requirements
- Capstan hoist operation

THE Z359 FALL PROTECTION CODE

ANSI/ASSE Z359.0-2012

Definitions and Nomenclature Used for Fall Protection and Fall Arrest

ANSI/ASSE Z359.1-2007

Safety Requirements for Personal Fall Arrest Systems, Subsystems and Components

ANSI/ASSE Z359.2-2007

Minimum Requirements for a Comprehensive Managed Fall Protection Program

ANSI/ASSE Z359.3-2007

Safety Requirements for Positioning and Travel Restraint Systems

ANSI/ASSE Z359.4-2013

Safety Requirements for Assisted-Rescue and Self-Rescue Systems, Subsystems and Components

ANSI/ASSE Z359.6-2009

Specifications and Design Requirements for Active Fall Protection Systems

ANSI/ASSE Z359.7-2011

Qualification and Verification Testing of Fall Protection Products

ANSI/ASSE Z359.11-2014

Safety Requirements for Full Body Harnesses

ANSI/ASSE Z359.12-2009

Connecting Components for Personal Fall Arrest System

ANSI/ASSE Z359.13-2013

Personal Energy Absorbers and Energy Absorbing Lanyards

ANSI/ASSE Z359.14-2014

Safety Requirements for Self-Retracting Devices For Personal Fall Arrest and Rescue Systems

ANSI/ASSE Z359.15-2014

Safety Requirements for Single Anchor Lifelines and Fall Arresters for Personal Fall Arrest and Rescue Systems

CSA S37-13 ANTENNAS, TOWERS, & ANTENNA SUPPORTING STRUCTURES

1. Scope
2. Reference publications
3. Definitions and symbols
4. Design requirements
5. Loads
6. Analysis
7. Structural steel
8. Corrosion protection
9. Other structural materials
10. Guy assemblies
11. Foundations and anchorages
12. Tower and pole structure installation
13. Obstruction lighting
14. Bonding and grounding
15. Insulator and insulation
16. Ladders, safety devices, platforms and cages

TIA-222-G

(ENGINEERING STANDARD)

This Standard provides the requirements for the structural design and fabrication of new and the modification of existing structural antennas, antenna-supporting structures, mounts, structural components, guy assemblies, insulators and foundations.

ANSI/TIA-322

(ENGINEERING STANDARD)

Loading Criteria, Analysis, and Design Related to the Installation, Alteration and Maintenance of Communication Structures

CATALOG BADGES



New gear



#ClimbHigher favorites



Products videos available at www.youtube.com/gmesupply



Save money on our bundled products



Country of origin



Sizing charts available at www.gmesupply.com/sizing-charts



Free document download at www.gmesupply.com/knowledge-base



Lanyard free fall distances



ANSI Z359.14-2014 SRL & PFL classes



ANSI rated SRL-LE



ANSI Z308.1 First Aid classes



ASME B30 standard for lifting & rigging



EN388 glove protection level



ANSI 105 standard Glove cut resistance level



ANSI 107-2015 Hi-visibility gear



MOTIVATIONAL WORKPLACE BANNER

4' x 2' vinyl banner; designed to remind and encourage safety in any workplace; high contrast signs are easy to read and visible from a distance; made of premium extra-heavy duty UltraFlex 15 oz PVC material; capable of withstanding harsh outdoor environments; fade, tear, fungus, and scratch resistant; stable down to -20°F; grommets allow for convenient hanging; many designs available or customize your own!

2083 4' x 2' "#Real Tower Climber" - \$29.99

2902 4' x 2' "Climb Higher" - \$29.99

2070C 4' x 2' Custom design, submit your print ready artwork - \$49.99



GME SUPPLY "CLIMB HIGHER" FITTED HAT

Made from 98% cotton/ 2% spandex this FlexFit hat is made from cotton twill and offers an athletic, mid-profile design. The front of the hat displays "Climb Higher", and the side includes the GME Supply logo. Available in sizes: S/M (6-3/4" - 7-1/4") or L/XL (7-1/8" - 7-5/8").

12001 - \$24.99



GME SUPPLY "CLIMB HIGHER" POWER BANK

Power up your mobile devices on the go with the GME Supply Power Bank. Use the power bank as a battery charger for your electronic devices. It delivers 2,220 mAh to your phone by connecting it with the included charging cable. Includes a micro USB to charge the power bank's rechargeable lithium battery. Small and compact, 7/8" x 3-3/4" x 1".

11031 - \$19.99

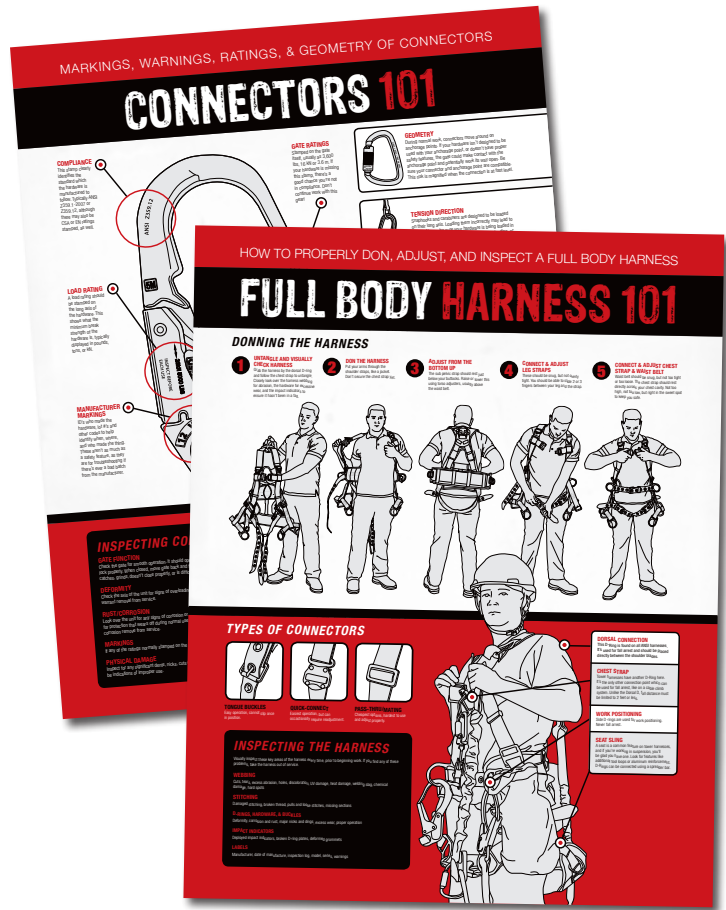

GME SUPPLY SAFETY POSTERS

Hang this educational 19" x 27" full-color, 100 lb glossy posters in your office, training facility, work shop, or even your man cave to heighten awareness, prevent injuries, and show of your tower climber pride.

2201 Full body harness 101 - \$14.95

2202 Connectors 101 - \$14.95



GME SUPPLY STICKER PACK

Show off your tower climbing pride with GME Supply stickers. This sticker pack includes (10) 2" x 2" poly laminate stickers. The GME Supply flame logo is featured on each. Snag a pack to add some swag to your climbing helmet and gear, or even hand some out to your crew.

11033 - \$3.99



GME SUPPLY BUMPER STICKER

Show off your tower climbing pride with a GME Supply Bumper Sticker. Add some swag to your trucks and trailers with this 4" x 4" bumper sticker. Made from 4 mil white vinyl, these bumper stickers have a high gloss finish, and are weather-resistant for indoor or outdoor use. The GME Supply "Climb Higher" logo is featured on each. Purchase an individual bumper sticker, or snag a 5-pack at a discount to hand out to your crew.

11035 1 Sticker - \$1.99

11036 5 Pack - \$6.99

SEE MORE GME SHIRTS
ON PAGE 152 }



GME SUPPLY "CLIMB HIGHER" HI-VIS SHORT SLEEVE T-SHIRT

Show your tower climbing pride with this custom designed "Climb Higher" T-shirt! Quarter-turned to eliminate center crease; double-needle stitching throughout for increased durability; seamless rib at neck; taped shoulder-to-shoulder; pre-shunk short sleeve T-shirt; 100% cotton; available in sizes S-2XL.

10090 - \$14.99



GME SUPPLY "CLIMB HIGHER" SHORT SLEEVE T-SHIRT

Exclusive GME Supply "Climb Higher" design; quarter-turned to eliminate center crease; double-needle stitching throughout for increased durability; seamless rib at neck; taped shoulder-to-shoulder; pre-shunk short sleeve T-shirt; 100% cotton; available in sizes S-2XL.

10040 - \$12.99



GME SUPPLY "CLIMB HIGHER" BACKPACK

Carry your gear in the new GME Supply backpack. "Climb Higher" is largely displayed on the front to show your tower climbing pride. This large-sized backpack is made from durable materials and includes padded shoulder straps.

11032 - \$19.99



GME SUPPLY "CLIMB HIGHER" CONVERSE SHOES

Comfortably show off your tower climbing pride in these blackout edition Converse. The tongue of each shoe is embroidered with the "Climb Higher" logo. Wear these shoes with all our other GME Supply swag. Available in sizes 5-12 (including half sizes). Other colors available upon special request.

*These shoes are men's sizes and typically run a little big. To convert to women's, add 2 sizes. Please consider going down a size or half size when ordering. All sales are FINAL and cannot be returned/exchanged once completed. The Converse tag is removed from the tongue of the shoe to allow for the embroidery.

MM-SHOE-BB - \$99.99

PELICAN ROPE

The Most Trusted Name in Rope®



Static Master II™

NEW

- Best in Class Handling
- Unique, Two Strand Design
- Smooth Rolling in Pulleys
- Reduced Drag
- Descending with Fine Control
- Ascend Faster

Our new Static Master II is constructed with a unique 32 strand construction. Two twill pattern braided strands per carrier provides a smoother running cover. Its incredibly smooth cover provides reduced drag through gear for faster ascending and finer control on descents. Its tough polyester cover provides excellent UV protection and high abrasion resistance. Its balanced nylon straight core provides a torque free rope.



Better Grab™ Positioning Lanyard

NEW

The new standard in positioning lanyards for tower and pole climbing work.

- U.S. Rigging Supply® ProClimb™ Better Grab
Stainless steel core
Ergonomic, rubberized cover
Anodized aluminum cam
Large thumb rest for precise control
- 1/2" or 5/8" Static Master rope.
- ANSI Z359.3-2007 certified.
- Chafe Master™ protective abrasion sleeve.



Load Pro™

- Leading High Force Load Line
- Factory Spliced Eyes
- Tough & Abrasion Resistant
- Stays Round on Capstan

Ideal For:
Cable Pulling, Stringing Lines, Winch Lines,
Lifting Lines, and Capstan Winches





FROM THE COVER

DBI Sala ExoFit XP Tower Climbing Harness *pg 8*, FallTech Flex-NoPac Twin Leg Shock Absorbing Lanyard *pg 34*, Petzl Grillon Adjustable Rope Positioning Lanyard *pg 41*, WestFall Pro Aluminum Carabiners *pg 58-59*, WestFall Pro Separator Snaphook *pg 59*, DBI Sala X2 Wire Cable Safety Sleeve *pg 86*, GME Supply Canvas Utility Bag *pg 116*, Petzl Vertex Vent Helmet *pg 120*, Bouton Anser Safety Glasses *pg 125*, Oliver Boots *pg 154*.

THIS PAGE

LEFT: DBI Sala ExoFit Tower Climbing Harness *pg 8*, FallTech ElasTech Twin Leg Shock Absorbing Lanyard *pg 35*, DBI Sala Wire Cable Safety Sleeve *pg 86*, Petzl Vertex Vent Helmet *pg 120*, Bouton Safety Glasses *pg 124-125*.

MIDDLE: MSA V-Gard Full Brim Hard Hat *pg 123*, Bolle Safety Glasses *pg 124-125*.

RIGHT: DBI Sala ExoFit XP Tower Climbing Harness *pg 8*, FallTech ElasTech Twin Leg Shock Absorbing Lanyard *pg 35*, DBI Sala Wire Cable Safety Sleeve *pg 86*, Petzl Grillon Adjustable Rope Positioning Lanyard *pg 41*, WestFall Pro Separator Snaphook *pg 59*, Petzl Vertex Vent Helmet *pg 120*, Bolle Safety Glasses *pg 124-125*, Ergodyne Knee Pads *pg 141*.

FEATURED BRANDS

3M / DBI Sala.....	30-31
Elk River Inc.....	13
FieldSENSE.....	201
Guardian Fall Protection.....	19
Hubbell.....	92
Kenwood.....	194
Multiwave Sensors.....	198
NATE.....	4
Pelican Rope.....	210
Petzl.....	25
PIP.....	136

Rock Exotica.....	73
Safety LMS.....	203
Skylotec.....	43
WestFall Pro.....	52

KNOWLEDGE INDEX

6 ft vs 12 ft Free Fall.....	32
ABCD's of Fall Protection.....	7
ASME B30 Rigging Standard.....	94
Connectors 101.....	61
First Aid 101.....	137
Full Body Harness 101.....	6
Gear Checklist.....	206

Glove Ratings 101.....	130
Hi-Visibility 101.....	148
Industrial Coatings 101.....	163
Inspection Log.....	205
Rope 101.....	62
Safety Can Color Coding.....	171
SRL, SRD, PFL 101.....	44
Standards Index.....	207
Suspension Trauma 101.....	29

View all of our knowledge content online at www.gmesupply.com/knowledge-base



GME Supply Co
 1391 E. Boone Industrial Blvd.
 Columbia, MO 65202



♥ **130 Likes** 4w
 • **gmesupply** #ClimbHigher-gram from @wage_slave3 perspective #RealTowerClimber



♥ **137 Likes** 17w
 • **gmesupply** #ClimbHigher-gram morning work view from @rfguys. #TowerClimber #800mhz



♥ **178 Likes** 19w
 • **gmesupply** Championship #ClimbHigher-gram from @jsunny7 in Vermont. #PatriotsNation

▶ TAG YOUR PHOTOS WITH #CLIMBHIGHER ON *Instagram* AND *twitter* TO BE FEATURED HERE AND IN OUR WEEKLY MAILER!



www.gmesupply.com
 (800) 940-6762

POWERED BY COLUMBIA SAFETY & SUPPLY

Corporate Office:
 1391 E. Boone Industrial Blvd., Columbia, MO 65202

Atlanta Branch:
 4720 Robinson Drive SW, Atlanta, GA 30336



\$ 1.99